

HEAT PUMP
VRF CATALOGUE
2023

HEAT PUMP VRF CATALOGUE 2023

FUJITSU GENERAL LIMITED

Fujitsu General (Thailand) Co., Ltd.



ISO 9001 Certification number: 01 100 075229
ISO 14001 Certification number: 01 104 9245

Fujitsu General (Shanghai) Co., Ltd.



ISO 9001 Certification number: 01 100 79269
ISO 14001 Certification number: CNB312244-UK

Fujitsu General Central Air-conditioner (Wuxi) Co., Ltd.



ISO 9001 Certification number: 15917Q20073R5M
ISO 14001 Certification number: 15918E20021R5M

- **GENERAL** is a worldwide trademark or registered trademark of Fujitsu General Limited in Japan and other countries or areas.
- **AIRSTAGE** is a worldwide trademark of Fujitsu General Limited and is a registered trademark in Japan and other countries and regions.
- **FGLair** is a worldwide trademark of Fujitsu General Limited.
- iPhone and iPod touch are trademarks of Apple Inc., registered in the United States and other countries.
- "Microsoft," "Windows," and "Direct X" are trademarks of Microsoft Corporation in the United States and other countries.
- "Intesis" is a trademark of HMS Industrial Networks in the European Union and is trademarked in the rest of the world.
- "IntesisHome" is a trademark of Intesis Software S.L.
- "LONWORKS" and "Echelon" are trademarks of Echelon Corporation registered in the United States and other countries.
- "Adobe" and "Reader" are either registered trademarks or trademarks of Adobe Systems Incorporated in the United States and/or other countries.
- "Android" is a trademark of Google LLC.
- Other company and product names mentioned in this document may be the registered trademarks, trademarks or trade names of their respective owners.
- Actual products' colors may be different from the colors shown in this printed material.

Distributed by :

FUJITSU GENERAL LIMITED

3-3-17, Suenaga, Takatsu-ku, Kawasaki, Kanagawa, 213-8502, Japan
www.fujitsu-general.com



Copyright© 2013-2023 Fujitsu General Limited. All rights reserved. 6AG009-2303E



INVERTER

FUJITSU GENERAL LIMITED

OUR MESSAGE

SOLUTIONS

CORE TECHNOLOGY

AIRSTAGE™ SERIES

INDOOR UNITS

VENTILATION

CONTROL SYSTEMS

OPTION

SUPPORT

3D Flow Cassette

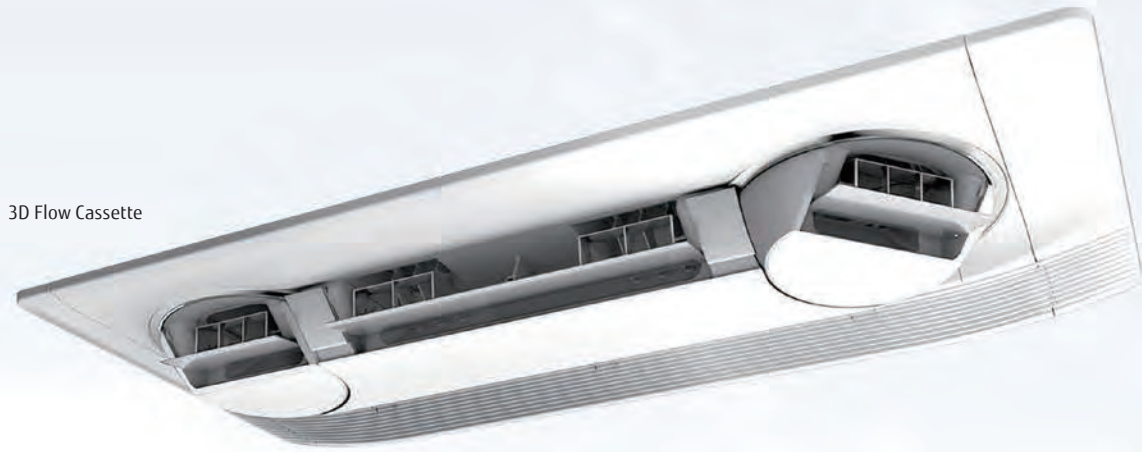

DESIGN for COMFORT

VRF J-III
14/16/18 HP model



VRF V-III
8 HP model



The VRF Series provides high energy savings, comfort, and reliability to the end user.

The design, installation, and servicing were developed based on the concepts of high flexibility and simplicity.

We offer an abundant VRF system lineup to match regional and customer needs by providing the best combination from low to high capacities and from giving priority to conserving installation space to giving priority to high efficiency.

For Light Commercial

VRF J-III

Heat Pump type
for heating or cooling operation
8 HP - 12 HP 3 Models
14 HP - 16 HP & 18 HP 3 Models/3 phase



VRF J-III

Heat Pump type
for heating or cooling operation
4 HP - 6 HP 6 Models/Single phase, 3 phase



VRF J-IIS

Heat Pump type
for heating or cooling operation
4 HP - 6 HP 3 Models/Single phase



For Commercial

VRF V-III

Heat Pump Modular type
for heating or cooling operation
8 HP - 54 HP 39 Models
Space saving combinations:
8 HP to 54 HP/24 models
Energy efficiency combinations:
16 HP to 46 HP/15 models



Contents

- 004 OUR HISTORY
- 006 WORLDWIDE LOCATIONS
- 008 GLOBAL BUSINESS ACTIVITIES
- 010 PROJECT REFERENCE
- 012 GLOBAL DEVELOPMENT & PRODUCTION BASES
- 014 HIGH QUALITY DEVELOPMENT & PRODUCTION FACILITIES

016 SOLUTIONS

- 016 OUR SOLUTION FOR ALL PROPERTIES
- 018 Light Commercial Solutions
- 026 Commercial Solutions

028 VRF CORE TECHNOLOGY

- 030 HIGH ENERGY EFFICIENCY
- 032 MORE COMFORT
- 034 HIGH RELIABILITY
- 036 DESIGN FLEXIBILITY
- 038 EASY INSTALLATION
- 040 EASY SERVICE & MAINTENANCE

042 VRF SERIES

- 044 VRF Series LINE-UP
- 046 HEAT PUMP TYPE VRF J-III Series
- 052 HEAT PUMP TYPE VRF J-III Series
- 056 HEAT PUMP TYPE VRF J-III TROPICAL Series
- 060 HEAT PUMP TYPE VRF J-IIS Series
- 064 HEAT PUMP TYPE VRF V-III Series
- 070 HEAT PUMP TYPE VRF V-III TROPICAL Series

076 VRF INDOOR UNITS

- 078 INDOOR UNITS LINE-UP
- 080 Cassette (1-way Flow type)
- 082 3D Flow Cassette
- 084 4-way Flow Compact Cassette
- 088 4-way Flow Cassette
- 092 Circular Flow Cassette
- 094 Mini Duct
- 096 Low Static Pressure Duct / Concealed Floor
- 098 Slim Duct / Slim Concealed Floor
- 100 Low / Medium Static Pressure Duct
- 102 High Static Pressure Duct
- 104 Floor (compact)
- 106 Floor / Ceiling
- 108 Ceiling
- 110 Wall Mounted

120 VENTILATION

- 122 Outdoor-air Processing Unit
- 124 DX Kit for air handling applications

126 CONTROL SYSTEMS

- 128 BEST CONTROL SOLUTION FOR EACH PROPERTY
- 130 CONTROL SYSTEM OVERVIEW
- 132 COMPARISON TABLE OF CONTROLLERS
- 134 INDIVIDUAL CONTROLLER
- 140 CENTRALIZED CONTROLLER
- 150 CONVERTER / ADAPTER

158 OPTION

- 160 External Power Supply Unit
- 161 Auto Louver Grille Kit
- 162 CONTROL SYSTEM LIST
- 164 OPTIONAL PARTS LIST
- 166 OPTIONAL PARTS
- 170 FUNCTION LIST
- 172 SEPARATION TUBE etc.

174 SUPPORT

- 176 SUPPORT
- 178 VRF / RAC SUPPORT TOOL
- 180 QUICK SERVICE & MAINTENANCE
- 182 SERVICE TOOL
- 184 WEB MONITORING TOOL

OUR HISTORY

Overseas Air Conditioning Business since 1971

1960: Air conditioning business starts. Japan-domestic business starts.

1971 Air conditioner exports to the Middle East.

1977 "Super Power, Super Quiet" Series released

1982 Window type 3 Super Series released
AL/AX Series



1985 Large wall-mounted type and multi-split air conditioner released.

WORLD'S FIRST *1,*2 **1991** World's first air conditioner equipped with lambda heat exchanger

1994 World's first air conditioner with power diffuser

2001 AIRSTAGE Series released VRF air conditioners for large buildings



WORLD'S FIRST *3 **2002** Air conditioner with the world's first automatic self-cleaning filter system

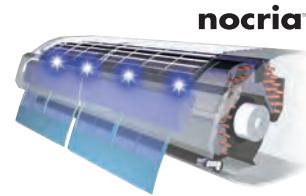

2004 Standalone Compact VRF AIRSTAGE J Series released



2006 VRF Heat Pump type Maximum 42 HP AIRSTAGE V Series released



2009 VRF Heat Pump Modular type Maximum 48 HP AIRSTAGE V-II Series released



2009 Air to water system released

WATERSTAGE

For Light commercial use

2011 High energy-saving type AIRSTAGE J-II Series released

2014 Compact & lightweight outdoor unit AIRSTAGE J-IIS equipped with a single fan for improved ease of installation

2016 Compact VRF AIRSTAGE J-III Series with advanced energy efficiency and easy installation released

2017-19 Compact VRF AIRSTAGE J-IIIIL Series for light commercial use released

2020 Compact & lightweight outdoor unit AIRSTAGE J-IVL, J-IV, J-IVS Series released



2019
New cassette style released
3D Flow Cassette

For Commercial use

2012 Heat Recovery Modular type AIRSTAGE VR-II Series Maximum 48 HP released



2014-15 Heat Pump Modular type AIRSTAGE V-III Series Maximum 54 HP for large buildings released

2020 Heat Recovery type AIRSTAGE VR-IV Series Maximum 48 HP released

2020
AIRSTAGE Air handling unit released

For Residential use

2011 Hi-spec Design model LT Series & LU Series released

2017 Flagship Wall-mounted type "nocria X" released

2017-19 Added to this lineup recently are the environment-friendly R32 refrigerant models. (Split & Multi-split type)



For Residential use

Split & Multi-split
New products released with Wall-mounted, Cassette, Ceiling, and Duct models



2023 What's New

1950 ~

1970 ~

2000 ~

2010 ~

Manufacturing Company Establishment

1955 Head Office established in Kawasaki
1964 Electronic components factory in Ichinoseki



1977 Air conditioner manufacturing company in Hamamatsu (now Hamamatsu business office)

1991 Air conditioner manufacturing company in Thailand

1994 Air conditioner manufacturing company in Shanghai, China

1998 Air conditioner motor manufacturing company in Thailand

2006 VRF air conditioner manufacturing, sale, and service company in China

2007 Air Conditioner Technology Building becomes operational on the premises of the Kawasaki Headquarters. Air conditioner R&D Center in Kawasaki

2009 Compressor Factory begins operation in Thailand

2012 Joint venture in Thailand to manufacture compressors

2016 Commercial use air conditioner R&D Center in Thailand



2019 New building constructed at Kawasaki Head Office to strengthen development capabilities:

Base for creating new value by combining internal and external knowledge



2020 Building IoT-based manufacturing

Implementing a real-time IoT system to instantly visualize and analyze various information



Fujitsu General (Thailand) Co., Ltd. (Thailand) Factory-2

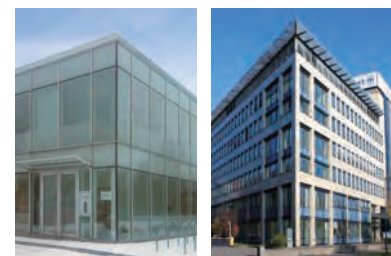

Fujitsu General (UK) Co., Ltd. (UK)



Fujitsu General (EURO) GmbH

Sales & service maintenance company established

1976 North America sales company

1977 Europe sales company (UK)

1978 Australia sales company and Europe sales company (Germany)

1980 Brazil sales company

1997 Asia sales company (Singapore)

1998 Middle East sales company (UAE) and New Zealand sales company

2000 Air conditioner manufacturing and sale technical partnership in India

2002 Taiwan sales company

2006 China sales company

2016 THE AIRSTAGE on Broadway in New York



*1: Announced 1991. In room air conditioner for the home (Our company's investigation) *2: Announced 1994. In the category of room air conditioners for the home (Our company's investigation). *3: Announced 2002. In the category of room air conditioners for the home (Our company's investigation).

*4: Announced 2018. In room air conditioner for the home (Our company's investigation) *5: Announced 2012. In room air conditioner for the home (Our company's investigation)

WORLD WIDE LOCATIONS

Under a system of five bases in Europe, the Middle East, Asia and Oceania, North and South America, and Japan, the company promotes Globalization from a worldwide perspective while emphasizing the actual conditions in each region.



JAPAN Head Office



Technology research building (Japan)

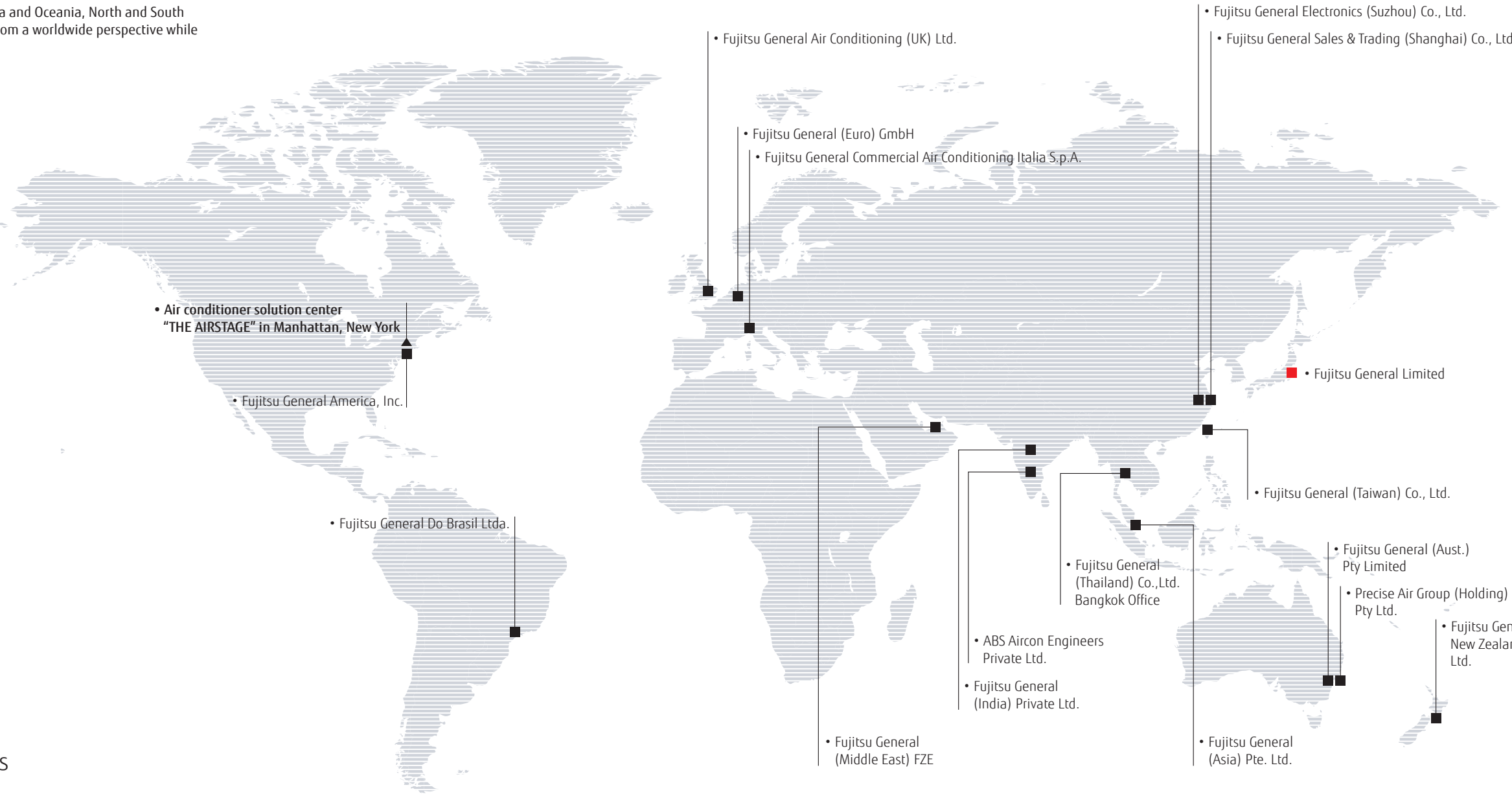

15 Overseas Sales Companies

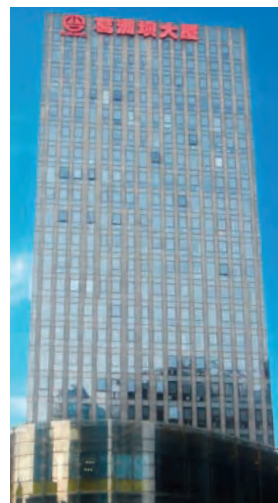

Fujitsu General Sales & Trading (Shanghai) Co., Ltd.



Fujitsu General (Taiwan) Co., Ltd. (Taiwan)



Fujitsu General (Thailand) Co.,Ltd. Bangkok Office (Thailand)



Fujitsu General (Asia) Pte. Ltd. (Singapore)



Fujitsu General (EURO) GmbH (Germany)



Fujitsu General Air Conditioning (UK) Ltd. (U.K.)



Fujitsu General Commercial Air Conditioning Italia S.p.A. (Italy)



Fujitsu General (India) Private Ltd. (India)



Fujitsu General (Aust.) Pty Ltd. (Australia)



Precise Air Group (Holding) Pty Ltd. (Australia)



Fujitsu General New Zealand Ltd. (New Zealand)



Fujitsu General (Middle East) FZE (U.A.E.)



FUJITSU GENERAL SOLUTION CENTER "THE AIRSTAGE" (U.S.A.)



ABS Aircon Engineers Private Ltd. (India)



Fujitsu General Do Brasil Ltda. (Brasil)



Fujitsu General America, Inc. (U.S.A.)

GLOBAL BUSINESS ACTIVITIES

We have been recognized for our activities in advertising, human resource development and customer service, as well as for our community-based social contribution activities in each region, winning numerous awards and achieving a high level of customer satisfaction.

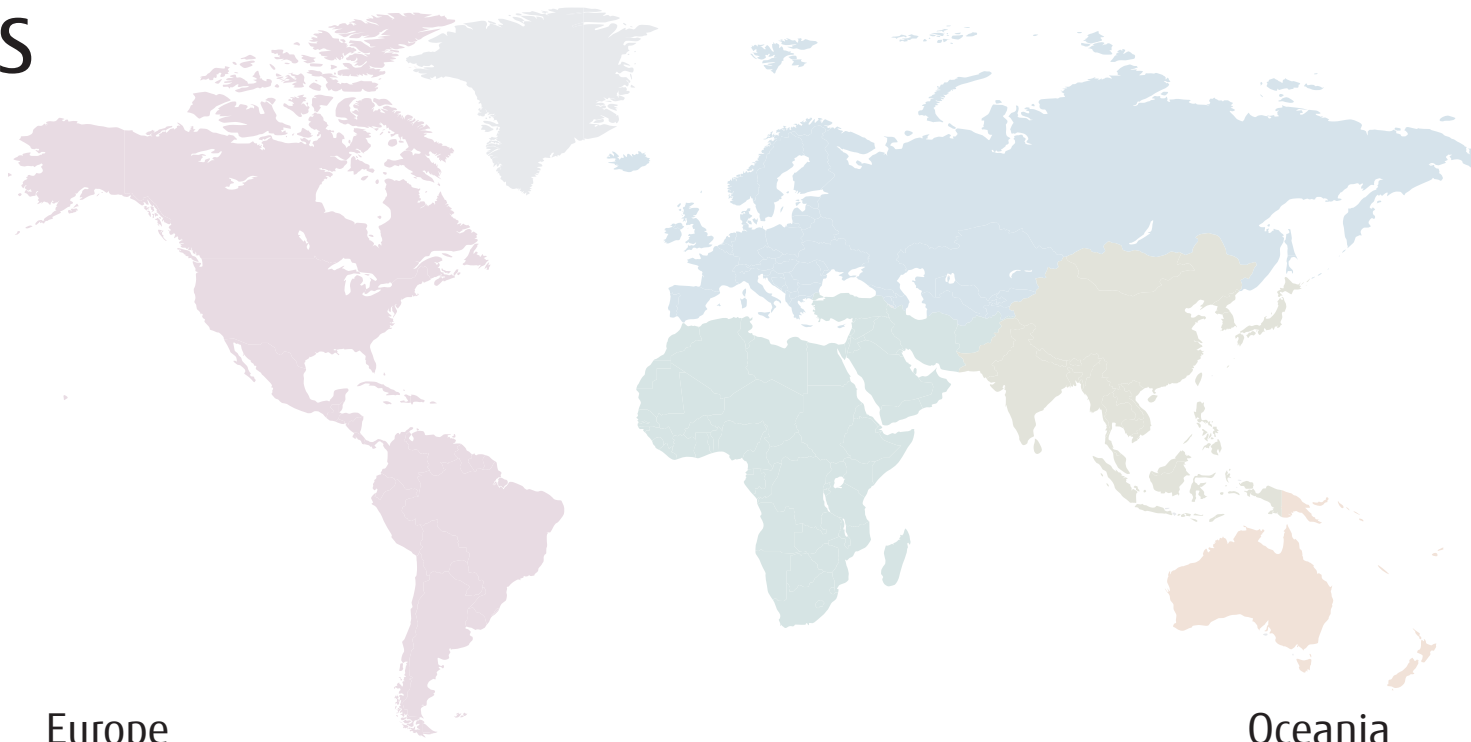

North and South Americas



AHR Expo



HVAC trade shows in Brazil



Distributor conference in USA



Call center

Middle East



Exhibition



Training in Kuwait



Technical seminar

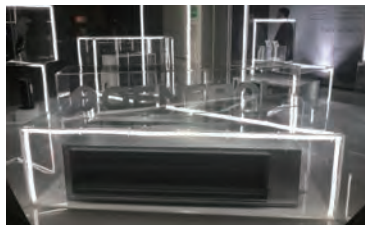

New product seminar in UAE

Europe



HVAC trade show in Germany



Training in Germany



HVAC trade show in Germany



Training seminar in Italy



Event in the United Kingdom

Oceania



HVAC trade show in Australia



Launch event in New Zealand



Launch event in New Zealand

Asia



Thanksgiving party in Taiwan



Training in India



Opening ceremony in India



New product presentation seminar in Singapore



Service training in Vietnam

International authoritative design awards



The NEWS Dealer Design Awards



Gold Award (Category: HVAC & PLUMBING) in Reader's Choice Awards



TOP OF MIND 2016 First prize in "MARCA DE EQUIPAMENTO DE AR-CONDICIONADO" category of "CLIMATIZACAO" division



Superbrands is the world's largest independent arbiter of branding.



The iF Product Design Award is given annually by iF International Forum Design GmbH for industrial products from around the world.



The Plus X Award is the world's largest innovation award for technology, sports and lifestyle.



reddot winner 2020

A product design competition that has been held since 1955. Products that win the award are given the "Red Dot" seal, a sign of international recognition of quality.



ProductReview.com.au's annual awards are selected from products and services that have been well-rated by the ProductReview community.



Voted by Australians as the 'Most Trusted Brand' - Air Conditioning Category 5 Years Running



China State Construction Engineering Luban Prize



The Good Design Award is an award sponsored by the Japan Institute of Design Promotion, and is given once a year to items of outstanding design.

PROJECT REFERENCE

Introduced in over 50 countries worldwide

Highly popular for their excellent quality, energy efficiency, and ease of installation, Fujitsu General's products are installed in a wide range of buildings around the world, including high-rise office buildings, stores, hotels, public facilities, schools, hospitals, and residences.

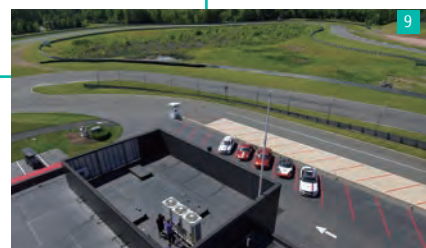
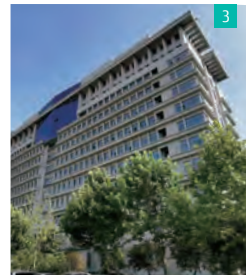

For Light commercial use

- 1 Shop in Europe
- 2 Factory in Europe
- 3 School in Asia
- 4 Hospital in Asia
- 5 Office in Asia
- 6 Shop in Oceania
- 7 Office in Oceania
- 8 School in the Middle East
- 9 Public facility in the United States

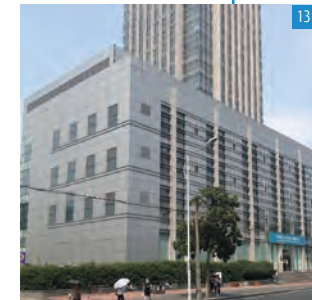

For Commercial use

- 10 Public Square in Asia
- 11 Office in Asia
- 12 Hotel in Asia
- 13 Public facility in Asia
- 14 Apartment in Oceania
- 15 Apartment in Oceania
- 16 Hotel in the Middle East
- 17 Hotel in the Middle East

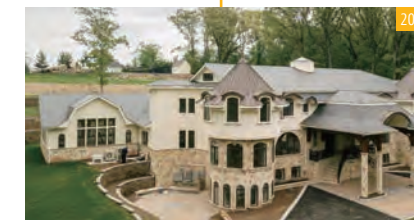

For Residential use

- 18 Villa in the Africa
- 19 Residence in Oceania
- 20 Residence in the United States
- 21 Villa in the Middle East

GLOBAL DEVELOPMENT & PRODUCTION BASES

We have established R&D bases in five countries from Japan, Europe, Asia, China, and North America to pursue environmental properties and comfort according to the needs of each region.

- Head Office
- R&D Center
- Manufacturing Companies

R&D center & Technology Research Building



R&D center in Fujitsu General (EURO) GmbH (Germany)



North America R&D Center (USA)



Fujitsu General Air Conditioning R&D (Thailand) Co., Ltd. (Thailand)



R&D center in Fujitsu General (Shanghai)



JAPAN Head office, R&D center and 60 m height difference testing tower (Japan)

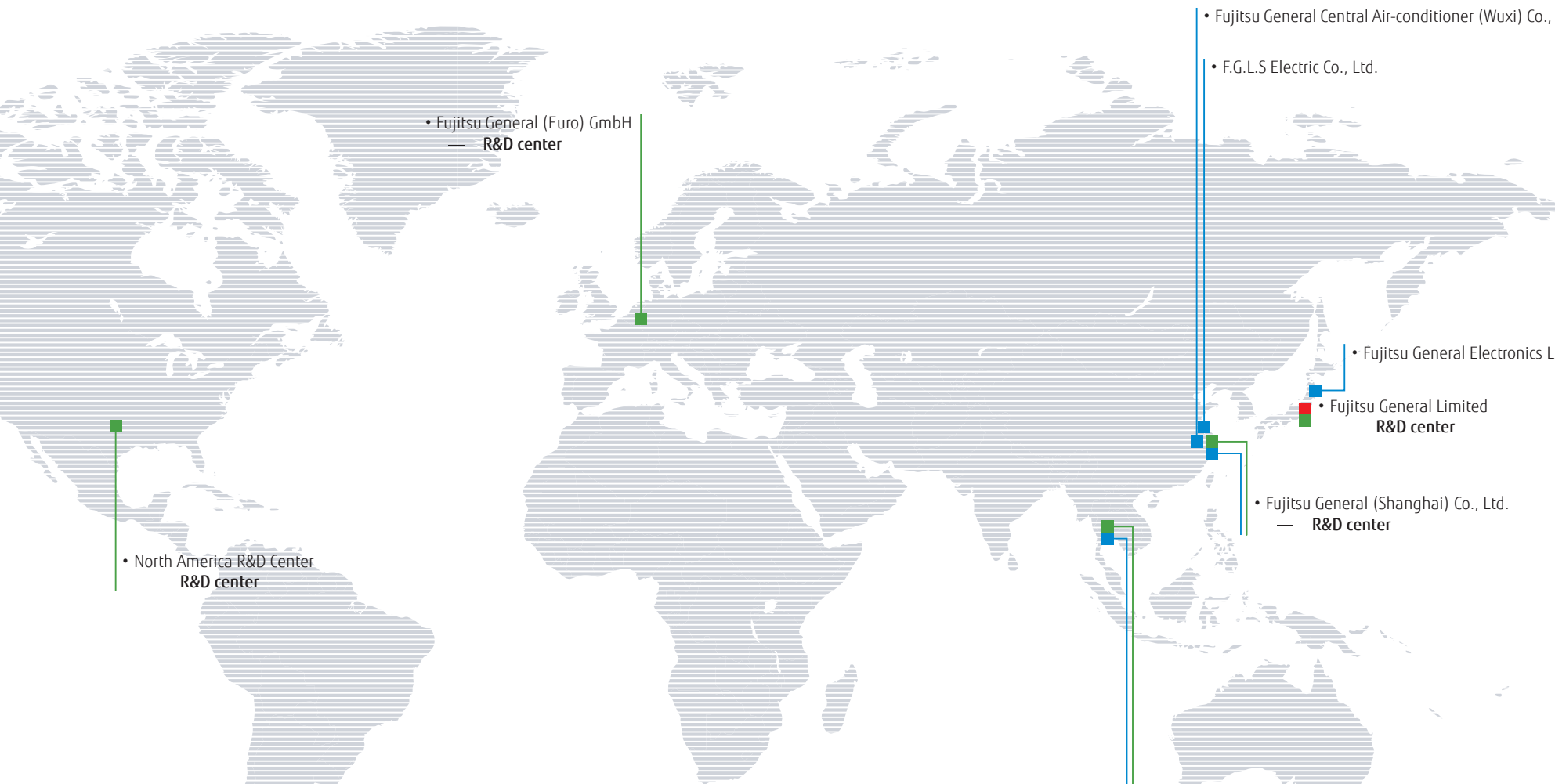

Constructing IoT-based manufacturing

We are implementing a real-time IoT-enabled system to immediately visualize and analyze various information such as facility operating status, assembly line production progress, and parts inventory and transportation status. This will further enhance the accuracy of production and shipping forecasts in the Head Office and factory management departments. The system will also help improve activities by employees at production sites, with the aim of improving the efficiency of the production process, the efficiency of parts distribution operations, and the utilization rates of the facilities.

Technology research building in Japan Head office



Overseas manufacturing companies



Fujitsu General (Shanghai) Co., Ltd. (China)



F.G.L.S Electric Co., Ltd. (China)



Fujitsu General Central Air-conditioner (Wuxi) Co., Ltd. (China)



Fujitsu General Electronics Ltd. (Japan)



Fujitsu General (Thailand) Co., Ltd. (Thailand) Factory-2



Fujitsu General (Thailand) Co., Ltd. (Thailand)



Fujitsu General Air Conditioning R&D (Thailand) Co., Ltd. (Thailand)



FGA (Thailand) Co., Ltd. (Thailand)



TCFG Compressor (Thailand) Co., Ltd. (Thailand)

HIGH QUALITY DEVELOPMENT & PRODUCTION

FACILITIES

Advanced Research Facility and Equipment

Performance Testing



Air Volume Measurement Room
Measure air volumes of the air conditioners from compact room air conditioner models to VRF.



Calorimeter
Measure the cooling/heating capacity by measuring the inlet and outlet temperatures, humidity, and air volume of the air conditioner.



Silent Room
Measure the operating sounds of air conditioners with the sound reflection-proof walls and ceiling.

Fujitsu General is one of Japan's leading manufacturers with an R&D Center in Japan. We provide customers with the highest quality and performance using these facilities.

Reliability Testing

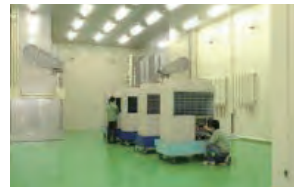

Constant Temperature Room
Check on the product performance in cooling/heating operation under the various temperature and humidity conditions.



Practical Test Room
Check on whether the air conditioners performance under the actual house conditions is sustainable.



Shower Test Room
Check on whether the electrical box of the outdoor unit is protected by rain waters with Typhoon like wind.

Transportation & Handling



Compressibility testing



Vibration testing



Technology Research Building in Japan Head Office

Testing Laboratory

Fujitsu General EMC Laboratory Limited

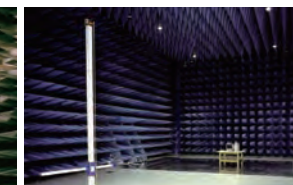
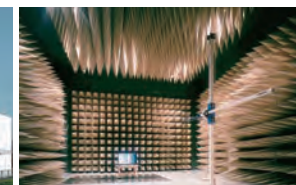

60 m Height Difference Testing Tower

Objective is to confirm oil circulation of compressor for reliability



Acquisition of ISO 9001 and ISO 14001

■ ISO 9001
■ ISO 14001
() Number of companies

Each of overseas production bases (5 companies) has completed the acquisition of ISO 9001 and ISO 14001 individually.

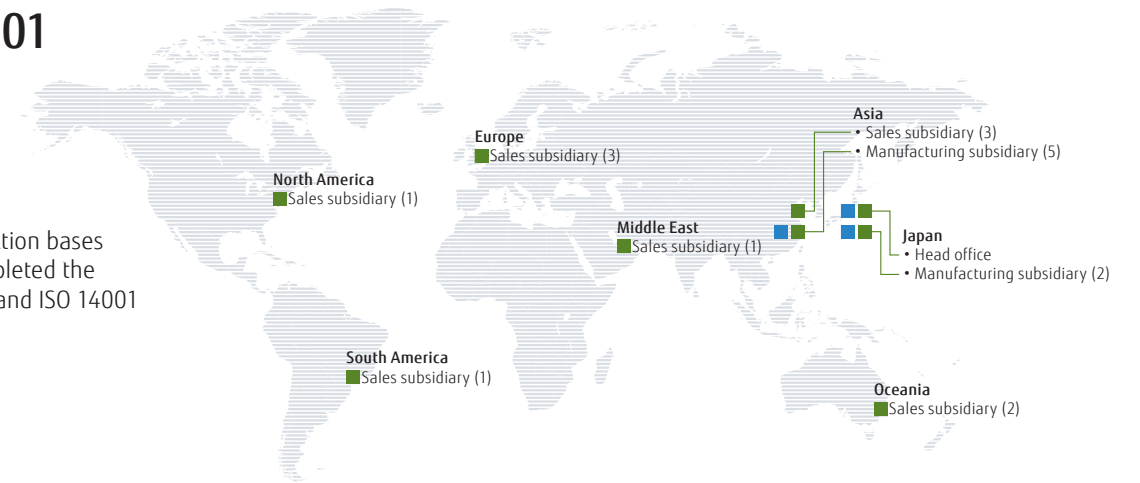

High Product Quality Assurance

All Fujitsu General factories have acquired ISO 9001, and have built a quality control system common around the world. High quality products are offered to all over the world based on stringent quality inspections.

Receiving inspection

Parts procurement requires a supplier's test report. European regulation RoHS inspection is also performed by special test department in-house. Total number inspection is performed especially on main parts to remove defectives.

Stringent product quality inspection

Stringent quality inspection is carried out at all production processes. High quality is maintained by stringent checks by inspectors and repetitive inspection.

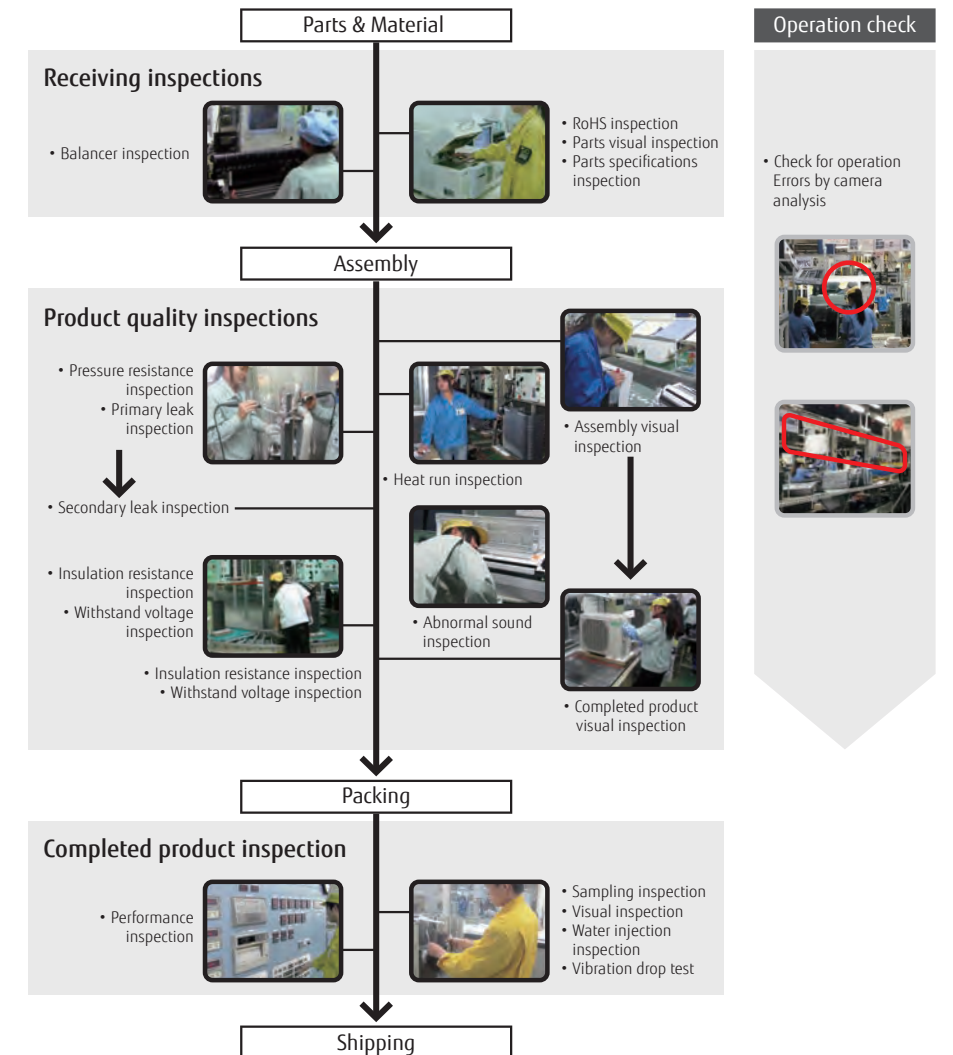

OUR SOLUTION FOR ALL

Fujitsu General provides the best solutions suitable for properties.

Solution Point

We provide Fujitsu General total solutions for the property unique needs.



PROPERTIES

Target Property

Light Commercial

For Small offices, Hotels, SCHOOL, Shops and Restaurant etc.

We offer comfortable and economical air conditioning systems focused on small to medium-sized buildings.



Commercial

For Large Building

We provide single and modular type VRF systems designed for high efficiency, comfort, freedom of design, easy installation and high reliability.

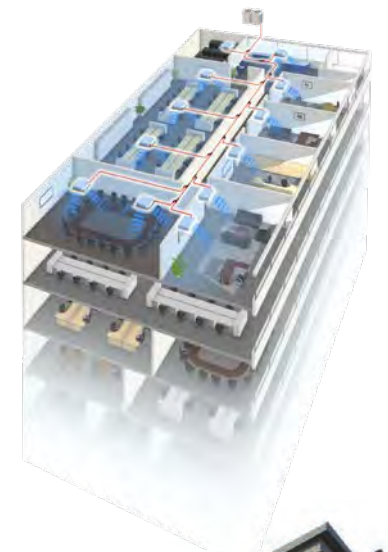

Small Offices

For Light Commercial

Fujitsu General provides perfect total air conditioning systems that take into account energy saving, low noise, comfortable airflow, small room application and centralized control for small-sized office buildings with many small rooms.



Breakthrough 3D flow cassette with innovative pursuit of comfort

The left and right air outlet ports with maximum 100° rotation angle and the wide center air outlet port can minimize uneven temperature to create a comfortable space.



Centralized remote controller with improved operability

Temperature management of each room and one week operation control management/settings are supported easily. This controller makes energy saving management possible with upper/lower temperature limit settings and operation prohibited settings.



Central Remote Controller UTY-DCGGZ2

Various indoor units lineup for low capacity class

Various range of low capacity indoor units to suit small rooms or spaces.



VRF J Series Up to 18 HP by compact outdoor unit

Small VRF system is suitable for the buildings with many small rooms. maximum 34* indoor units can be connected.

*Only J-IIIIL 18 HP model

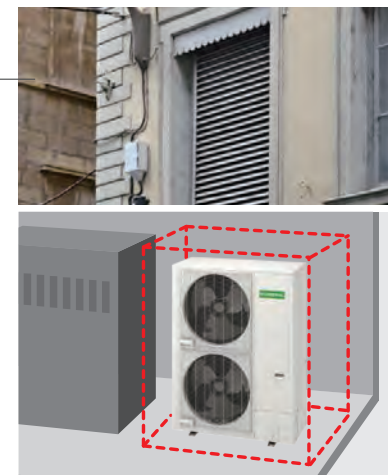

J-IIIIL

Compact and low noise design outdoor unit

This compact outdoor unit does not take up much space even if installed in a machine room or on the rooftop. This unit secures enough static pressure even if there are louvers. Low noise operation is possible at nighttime by a low noise mode.

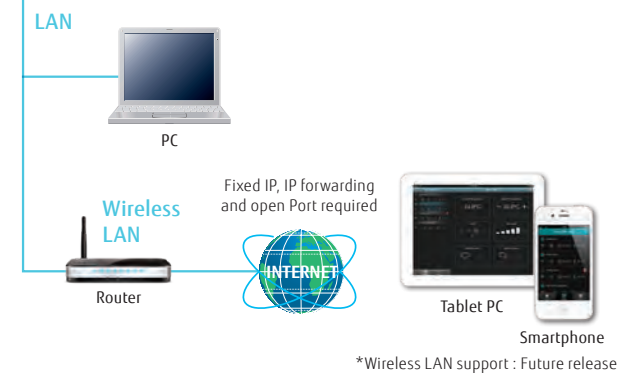

*Wireless LAN support : Future release

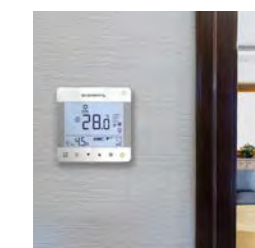

Compact wired remote controller

The size is compact but the screen is large and easy to operate. Stylish design that fits the interior.

Hotels

For Light Commercial

Fujitsu General provides perfect total air conditioning systems that take into account comfort, energy saving, external appearance, safety and easy installation for small low-rise hotels.

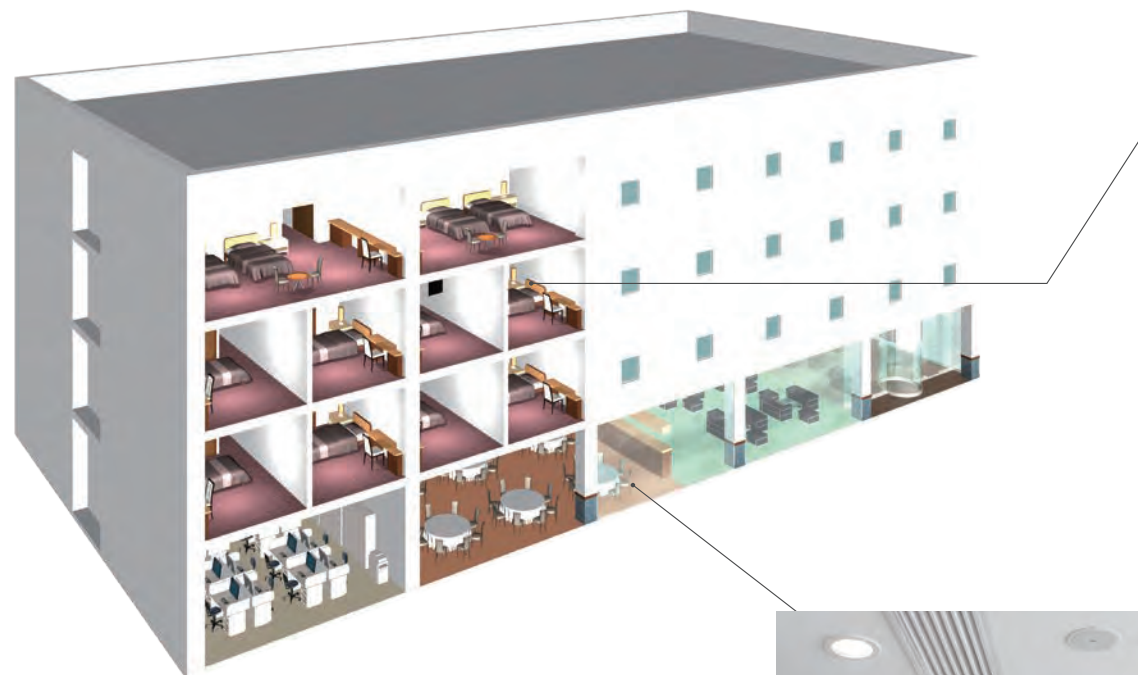

VRF J Series appearance-oriented compact outdoor unit

Due to the lowest and most compact design in the industry, the appearance of hotel is not damaged even when installed on the building.



Ventilation of the whole hotel supported

Outdoor air processing is essential in hotel spaces with a high degree of airtightness. The DX Kit can link up with air conditioners to ensure sufficient ventilation. This system can be expanded.

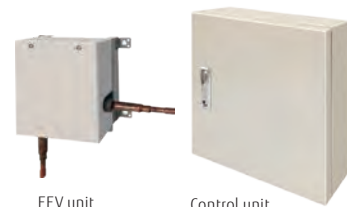

Guest room air conditioning with excellent comfort, energy saving and easy installation

Space saving
Mini duct type with 198 mm height and 450 mm depth. This can be installed in narrow ceiling space easily.



Mini Duct

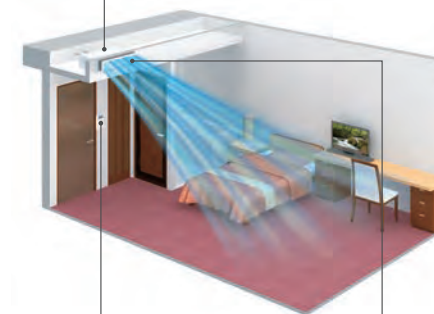

Card key switch available
Using the card key prevents you from forgetting to switch off the air conditioner.



Use of an external connect switch

Comfortable airflow that switches up and down air directions
The Auto Louver Grille Kit achieves comfortable airflow by adjusting the air direction.



Auto Louver Grille Kit

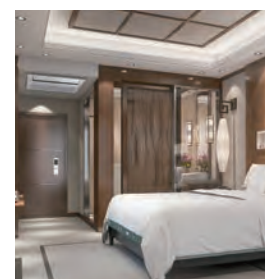

Cassette (1-way Flow type) Series

Compact chassis with low noise operation
The low operating noise makes the model ideal for use in hotel rooms.

Centralized control of air conditioning in shared spaces

Air conditioning in shared spaces such as lobbies and hallways is controlled centrally. Temperature and operating conditions can be managed without the adjustment by guests.



System controller

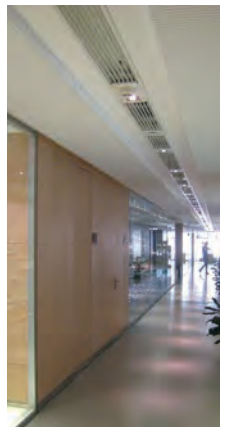

Simple Remote Controller with sophisticated design

Suitable for hotels or offices as it is easily operated with no complex functions. Large LCD screen & simple operation buttons White colored backlight on monitor enable easy operation in dark.



Large space air conditioning for the reception area and lobby

Duct type Big duct Series suitable for large spaces with high ceilings



School

For Light Commercial

Fujitsu General provides the optimal number of connected indoor units for mid-sized educational institutions. The degree of freedom of the installation location selection is improved with a compact design that minimizes the installation area. Even one outdoor unit can cover the entire school building.

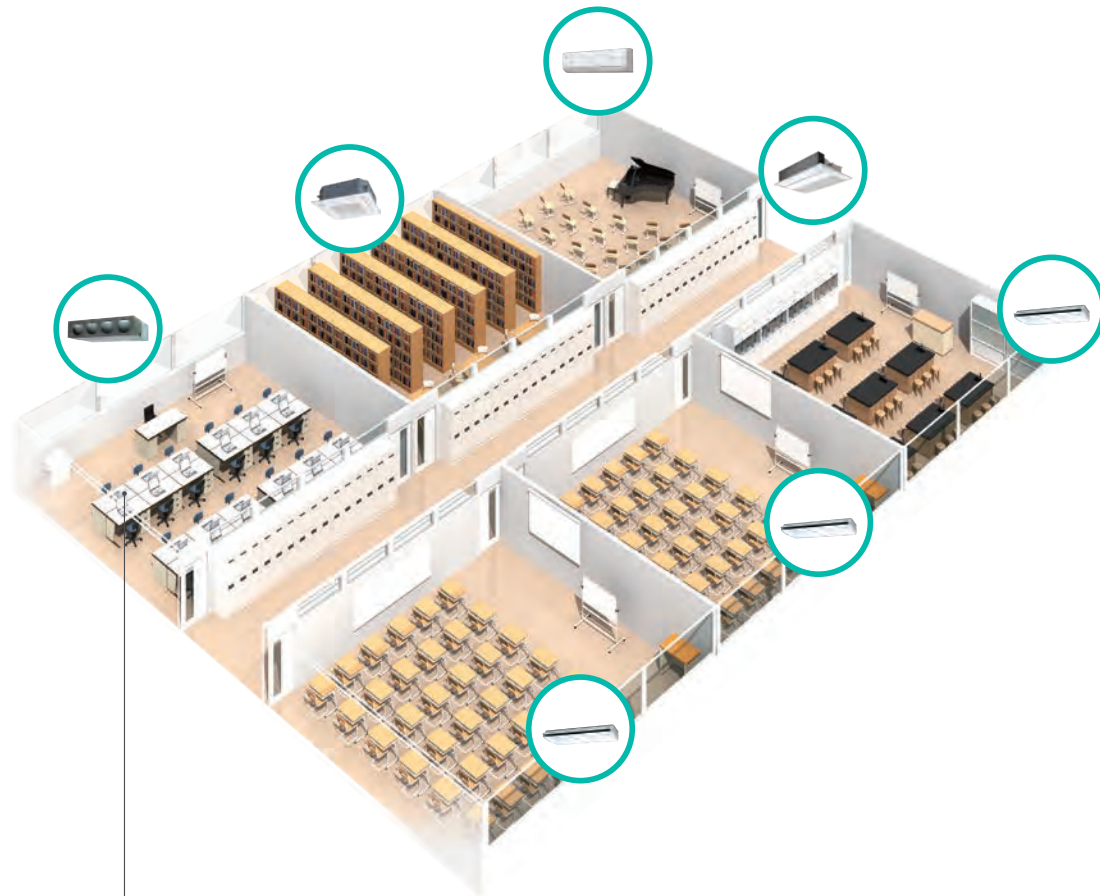

Centralized control of both air conditioning and ventilation equipment

It is possible to perform centralized control to stop the operation of lighting and ventilation equipment in addition to air conditioners. This is useful in energy saving management over the whole building.

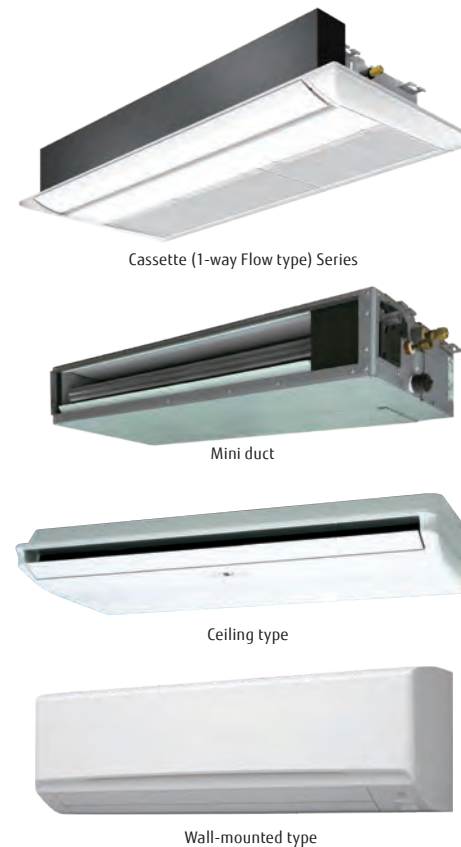
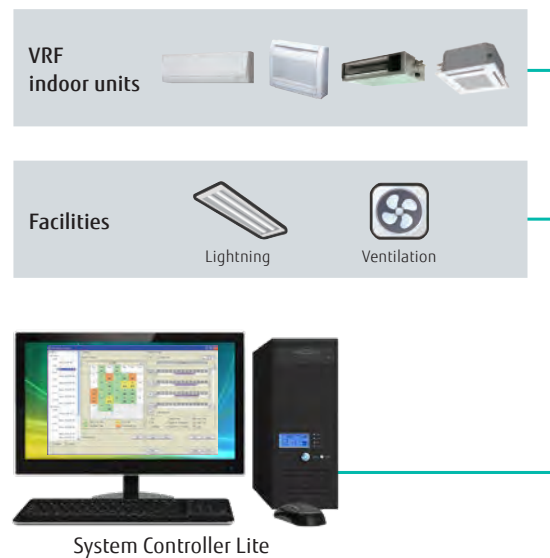

Various indoor units

We have a lineup of indoor units that can also support complex applications – from normal classrooms to special classrooms and auditoriums. Air conditioners can be also added easily.



Comfortable room air conditioning without airflow feeling
Circular Flow Cassette blows out in all directions without temperature unevenness

Individual airflow direction control to prevent people from being exposed to airflow

Energy saving operation when there are no people by linking up with human sensor
Occupancy sensor (Option)

Restaurant, Shops

For Light Commercial

Fujitsu General provides perfect total air conditioning systems that offer smooth support by tenant, by purpose and by customer visit frequency in shops and restaurants with multiple lighting and a high density of customers.



SOLUTIONS

RESTAURANT

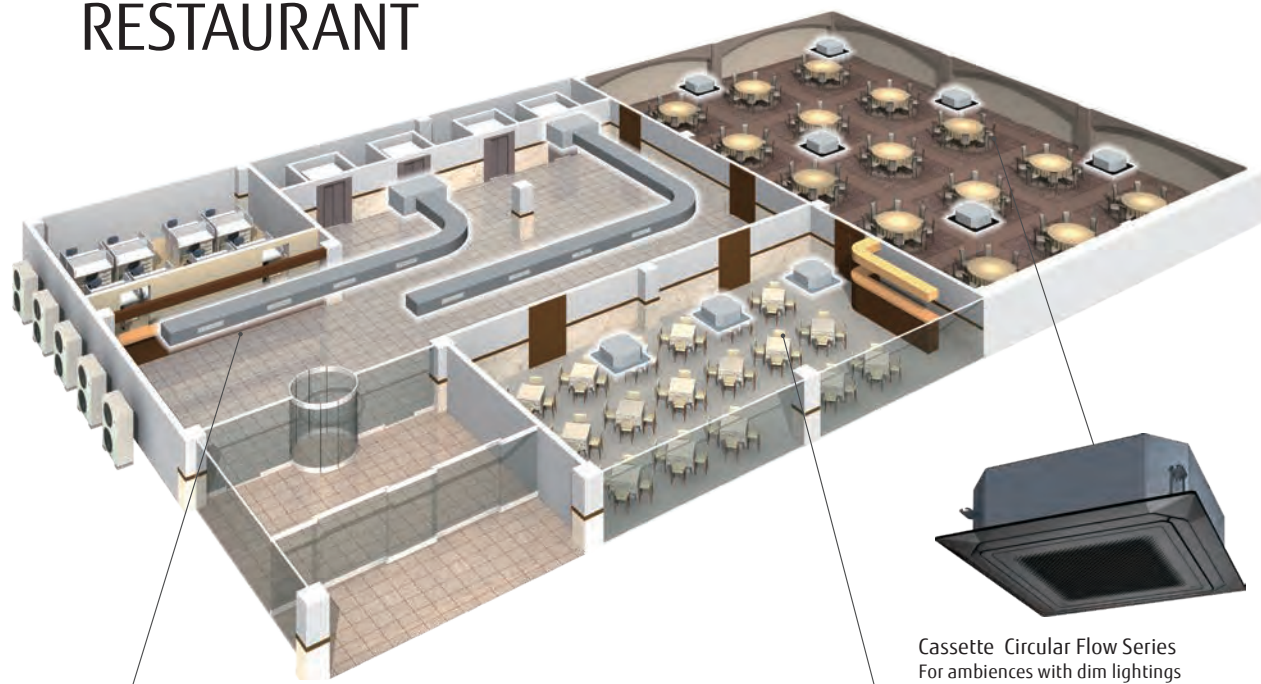

SHOPS



Appropriate air conditioning in the atrium space

Appropriate air conditioning of the high ceiling and glass-sided atrium space with a large duct system

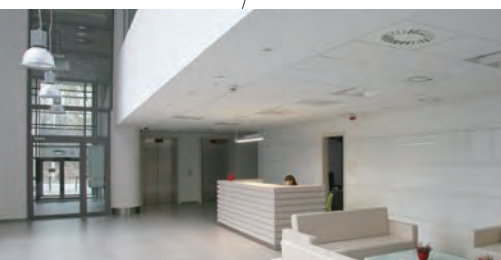

High Static Pressure Duct



Cassette Circular Flow Series
For ambiances with dim lightings



Cassette Circular Flow Series
For bright Interior rooms etc.

Color variations by two panels

Both black and white panels are available for Cassette type. Black panel is suitable for the dark place such as a restaurant with atmosphere. White panel is usually used at bright areas such as offices. (Available to single split and VRF indoor units)

Low outside air temperature cooling air conditioning support

Low outside air temperature cooling operation is necessary in winter in stores with a lot of heat inside. Air conditioning system can be supported flexibility to allow cooling operation at -15°C



Medium Static Pressure Duct

40-150 Pa



Large Building

For Commercial

Fujitsu General provides modular type VRF systems that seek high efficiency, comfort, design freedom, easy installation and reliability for skyscraper buildings.



Abundant lineup suitable to match the operating environment

VRF Series lineup to meet various needs such as energy saving-orientated models and models compatible with a high outdoor air temperature of 52°C



VRF V-III

Smart and cutting edge design. Extensive lineup from 8 HP to 54 HP in 2 HP increment. Connectable indoor unit capacity ratio up to 150%

8 HP - 54 HP 39 Models

- Space saving combinations: 8 HP to 54 HP/24 models
- Energy efficiency combinations: 16 HP to 46 HP/15 models

Individual air conditioning system for large buildings

Capacities can be expanded up to simultaneous cooling and heating with maximum 54HP. Large individual air conditioning is supported.



VRF V-III Tropical TROPICAL SPEC

8 HP - 54 HP 39 Models

- Space saving combinations: 8 HP to 54 HP/24 models
- Energy efficiency combinations: 16 HP to 46 HP/ 15 models

Centralized control

Not only indoor units in the building but also facilities such as ventilation can be controlled easily by anyone.

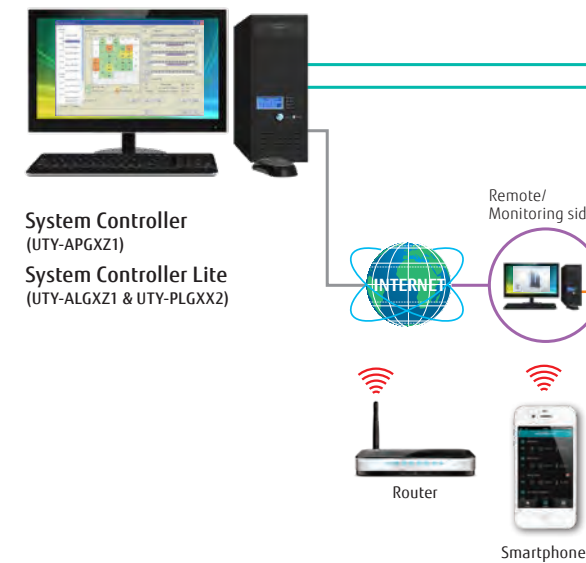

Link up with a variety of BMS

Centralized control including facilities and equipment in addition to air conditioning is possible by linking up with MODBUS, BACnet, KNX and other various interfaces.

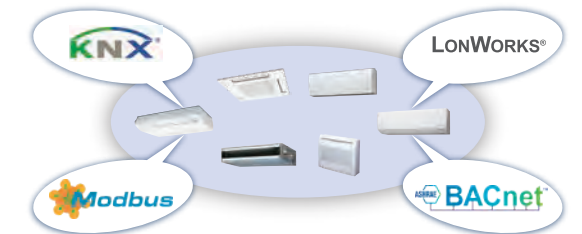

High system flexibility

Flexible installation on each floor and installation of diverse indoor units are possible through the industry's top class high static pressure, long piping design and connection capacity.

82 Pa

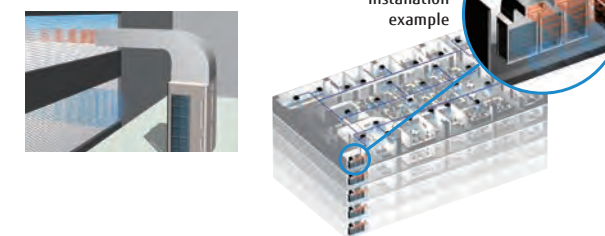

Rapid service support

The air conditioning of the entire building can be monitored remotely with Web Monitoring Tool and System Controller. Rapid response for emergency is possible by a self-diagnosis in advance in cooperation with a management company.

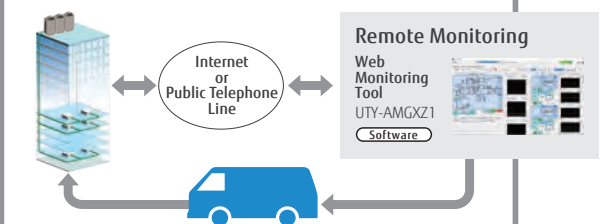



VRF CORE TECHNOLOGY

**VRF SYSTEMS CAN BE DESIGNED TO
CREATE AN AIR CONDITIONING SOLUTION TO
SUIT MOST BUILDINGS REQUIREMENTS.**

VRF Systems can be designed to effectively provide an air conditioning solution from a large domestic residence through to a large scale commercial building.

- HIGH ENERGY EFFICIENCY
- MORE COMFORT
- HIGH RELIABILITY
- DESIGN FLEXIBILITY
- EASY INSTALLATION
- EASY SERVICE & MAINTENANCE



HIGH ENERGY EFFICIENCY

Highly Energy Efficiency

Significantly efficiency is improved by using DC twin rotary compressor, inverter technology, and large heat exchanger.

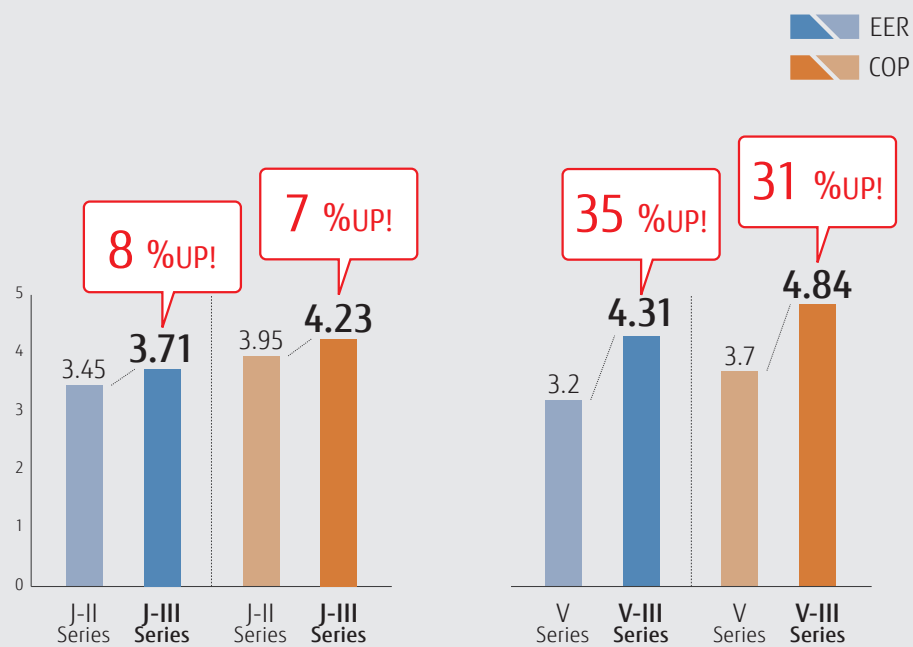

Operation Performance is Efficiently Controlled.

Room temperature set point limitation

The minimum and maximum temperature ranges can be limited, which provide further energy saving while maintaining the comfort of the occupants.

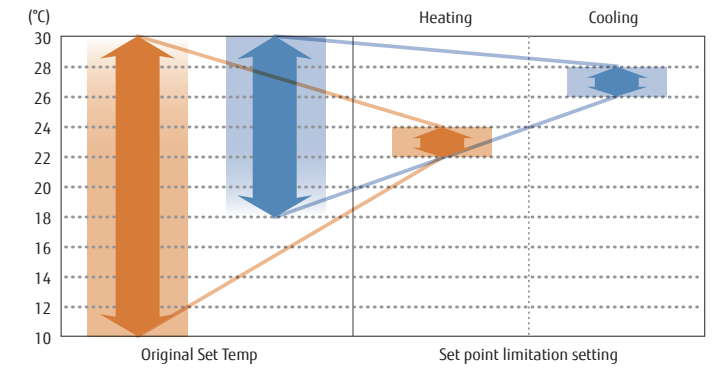

Auto-off timer

New wired remote controller is equipped with an OFF timer function that automatically stops operation when a fixed time has elapsed from the start of operation. This prevents waste of energy. Furthermore a new wired remote controller can set up the interval of time in case operation stops.

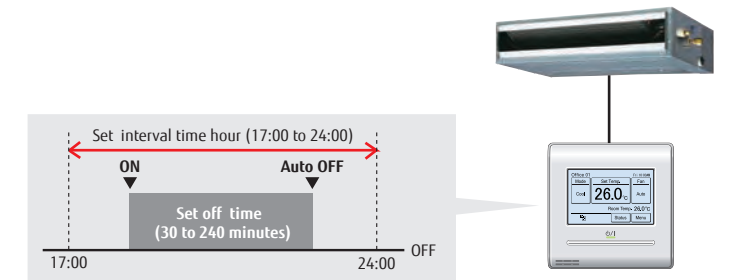

Energy saving management

A variety energy saving operations can be set and managed depending on the season, weather, and time period. Excellent energy saving operation is performed by using System Controller.

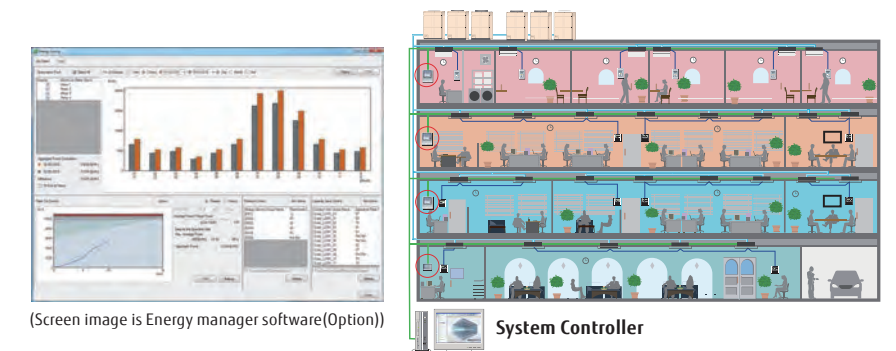

Capacity limit operation

Operation capacity can be set in 5 steps for rated capability. The power consumption at peak is cut down and the maximum load is suppressed.

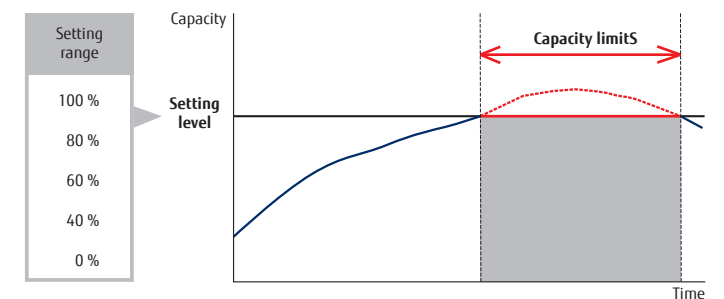

MORE COMFORT

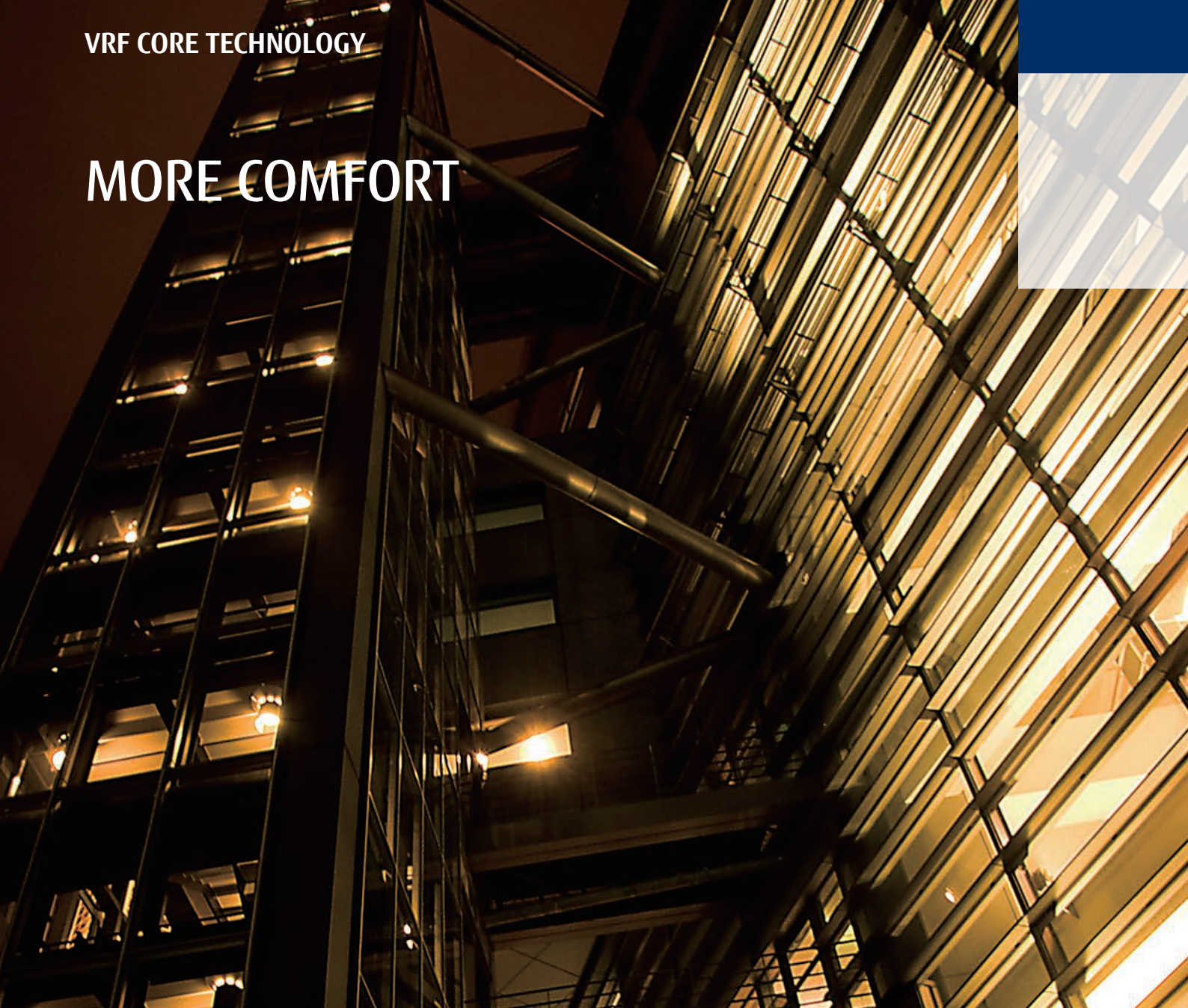

Auto changeover function

At Auto setting, the cooling/heating mode is automatically switched according to the set temperature and room temperature.

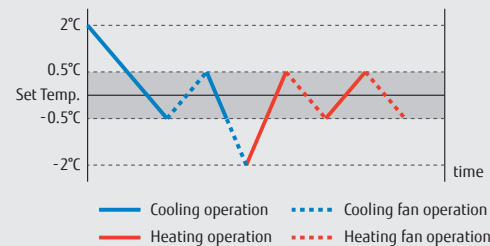

Automatic cooling / heating operation for each room is possible

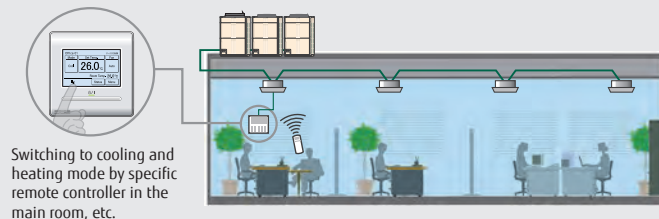
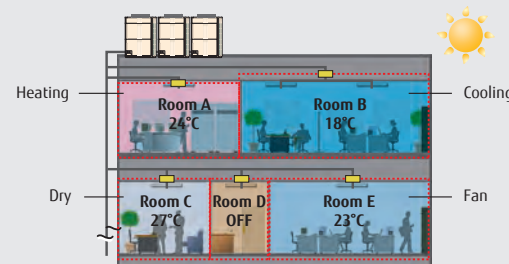

Auto changeover setting allows for the product to easily switch between cooling and heating modes regardless of the operation mode of other indoor units. This can be done via specific indoor unit with wired remote controller. This ensures comfortable operation all year round.

Precision refrigerant flow control

Precise and smooth refrigerant flow control is achieved by using a DC Inverter control in conjunction with individual indoor unit electronic expansion valve control. This allows high precision comfortable temperature control of $\pm 0.5^\circ\text{C}$.

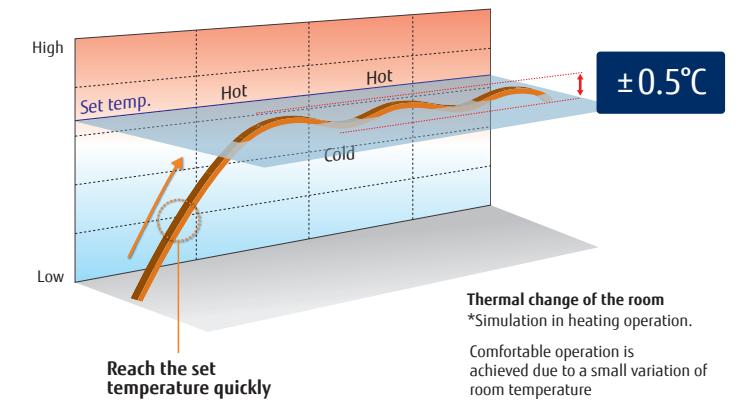

Low sound level design

Small capacity indoor units respond for the demands of several applications.

These models will be able to offer greater audibility comfort by operating at super low sound levels.



Small capacity indoor unit

Quiet operation

Low noise mode

Two low noise modes can be selected automatically by quiet priority setting and capacity priority setting depending on the indoor environment and outside temperature load. This feature can be controlled via outdoor unit external input and/or system controller.

Quiet priority setting

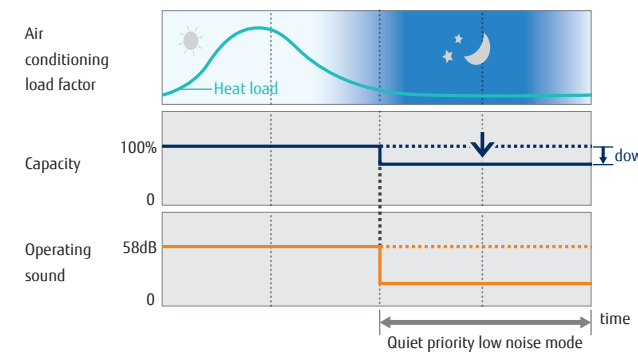

Capacity priority setting

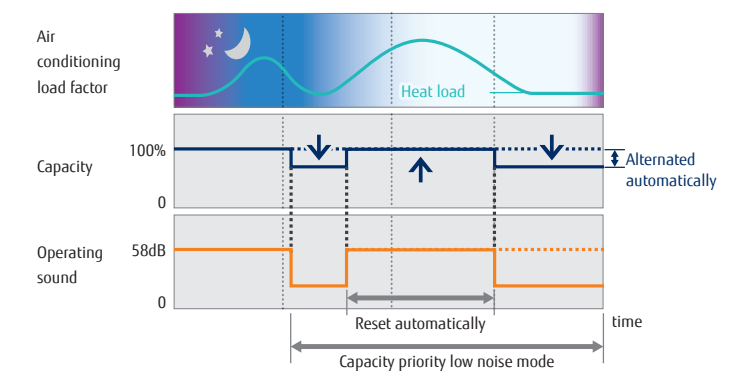

Non-stop oil recovery operation

A comfortable room condition is maintained during oil recovery mode because the product continues to operate without stopping the cooling or heating operation.

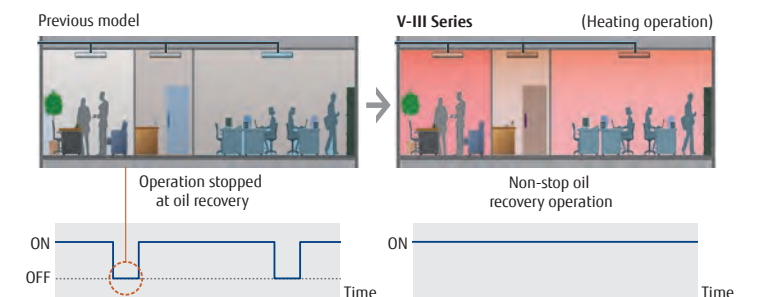

HIGH RELIABILITY



Outdoor unit rotational operation

The compressor starting order is rotated so that the running time is shared.

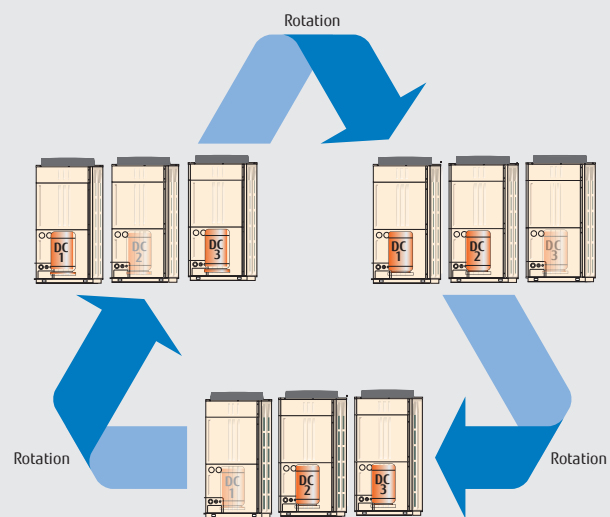

Note: Rotational operation is alternated by the start / stop timing of the compressor.

Backup operation

If one compressor fails, backup operation will be performed by the remaining compressors*.

*: Note: Backup operation may not be possible depending on the trouble state.

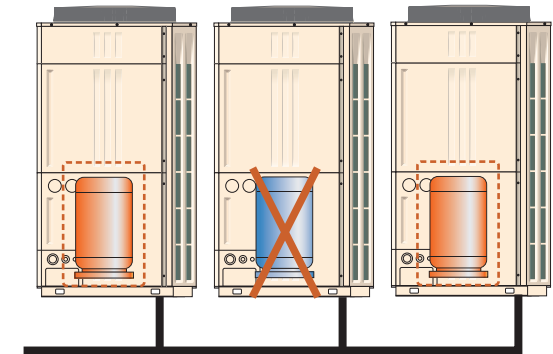

Advanced refrigerant control

Innovative compressor control logic has been introduced in order to balance the refrigerant mass flow rate of each outdoor unit by controlling the inverter speed.

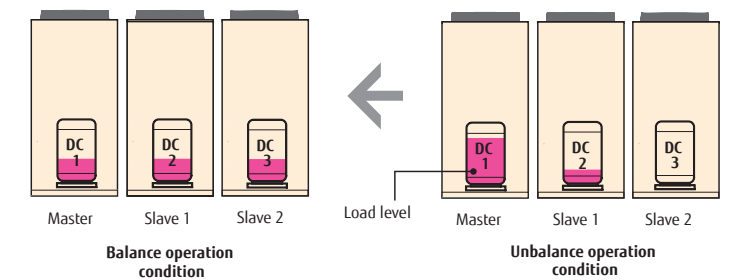

Liquid flow back protection

By adopting a large sized accumulator, the not completely vapourised refrigerant stays inside of the accumulator to ensure no liquid refrigerant is being fed into the compressor.

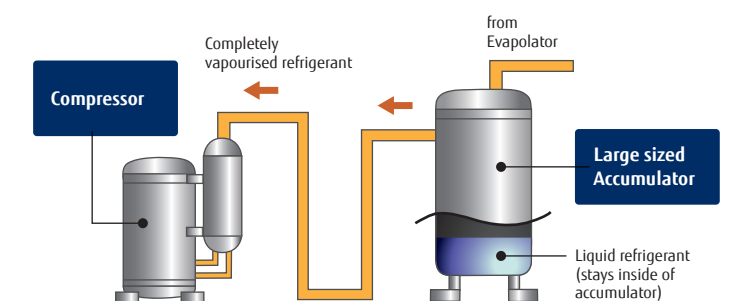

Adoption of blue fin heat exchanger

Corrosion resistant of the heat exchanger has been improved by the introduction of blue fin treatment to the outdoor unit's heat exchanger.

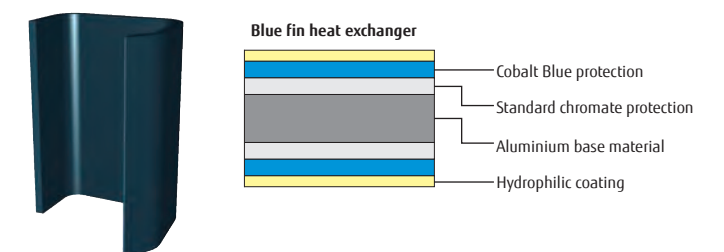

DESIGN FLEXIBILITY

Overall piping length 1,000m

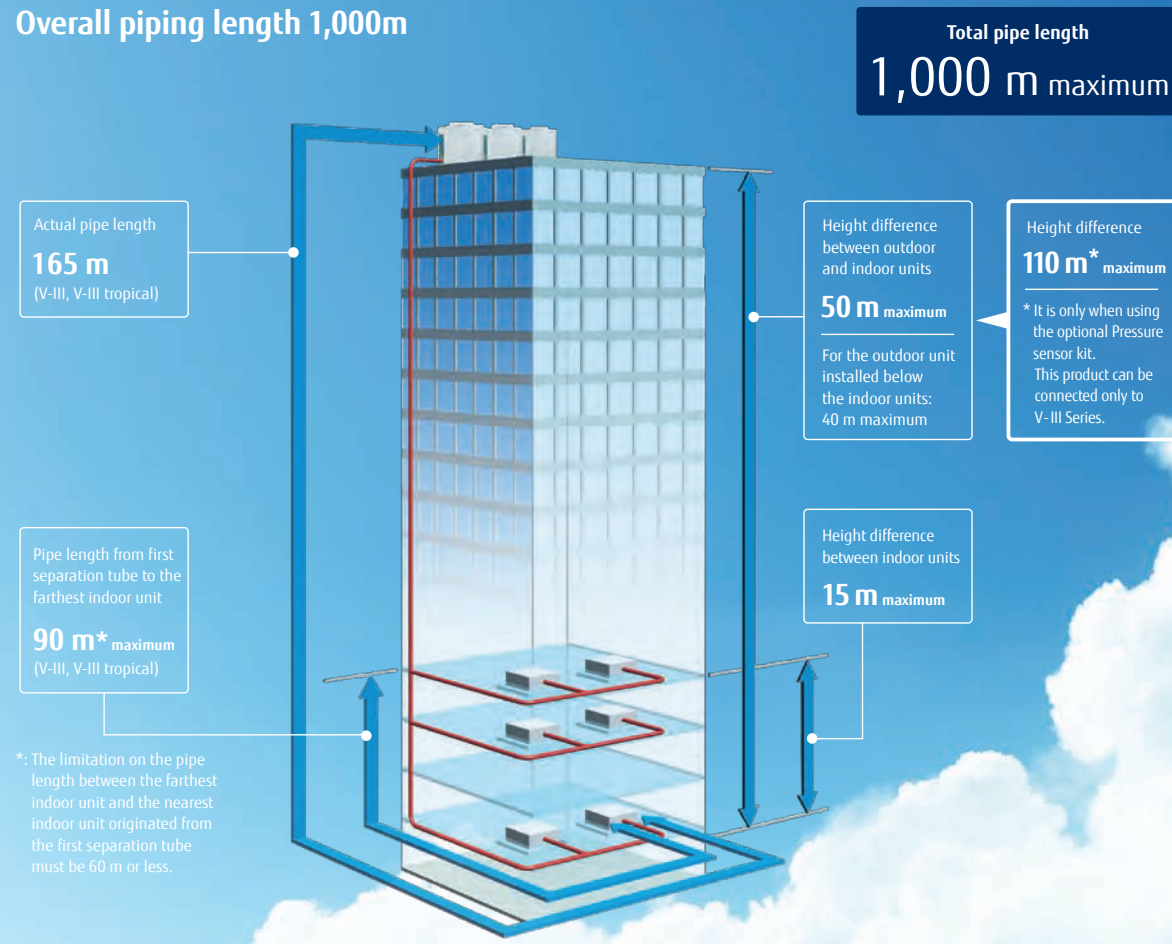

High static pressure

The outdoor unit can have a condenser hood easily connected with a static pressure of 82Pa. This allows outdoor units to be installed within plant rooms in high rise buildings.

Powerful discharge air prevents a short-circuit.

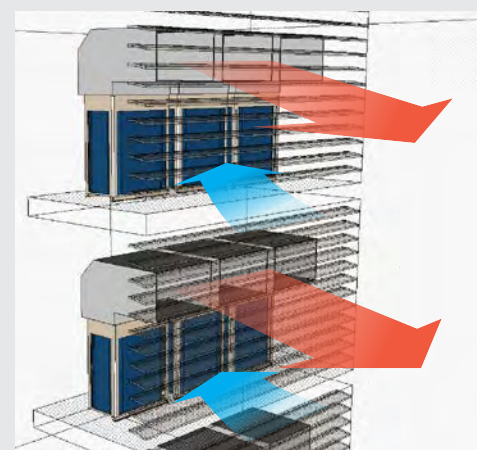

82 Pa
(V-III, V-III tropical)

Previous model

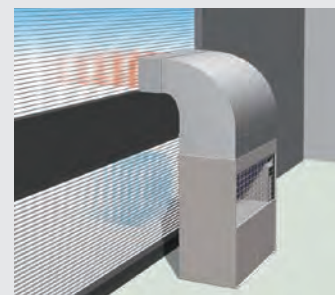

V-III, V-III tropical

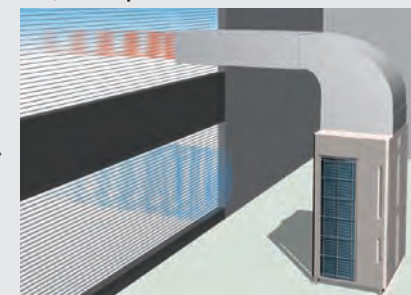

Large diameter fan and DC motor has been utilized allowing an external static pressure of 82Pa. This is approximately 2.6 times greater than the previous model.

High capacity connection

14HP-18HP VRF J-IIIIL Series Heat Pump type Connectable indoor unit capacity range 50 % to 150 % Connectable indoor unit number up to 34	8HP-12HP VRF J-IIIIL Series Heat Pump type Connectable indoor unit capacity range 50 % to 150 % Connectable indoor unit number up to 22	4HP-6HP VRF J-III Series Heat Pump type Connectable indoor unit capacity range 50 % to 150 % Connectable indoor unit number up to 13
4HP-6HP VRF J-III tropical Series Heat Pump type Connectable indoor unit capacity range 50 % to 130 % Connectable indoor unit number up to 9	4HP-6HP VRF J-IIS Series Heat Pump type Connectable indoor unit capacity range 50 % to 130 % Connectable indoor unit number up to 8	8HP-54HP VRF V-III Series Heat Pump type Connectable indoor unit capacity range 50 % to 150 % Connectable indoor unit number up to 64
8HP-54HP VRF V-III tropical Series Heat Pump type Connectable indoor unit capacity range 50 % to 130 % Connectable indoor unit number up to 55		

Wide operating range

Installation in extreme temperature conditions is possible due to an increase in operational range.

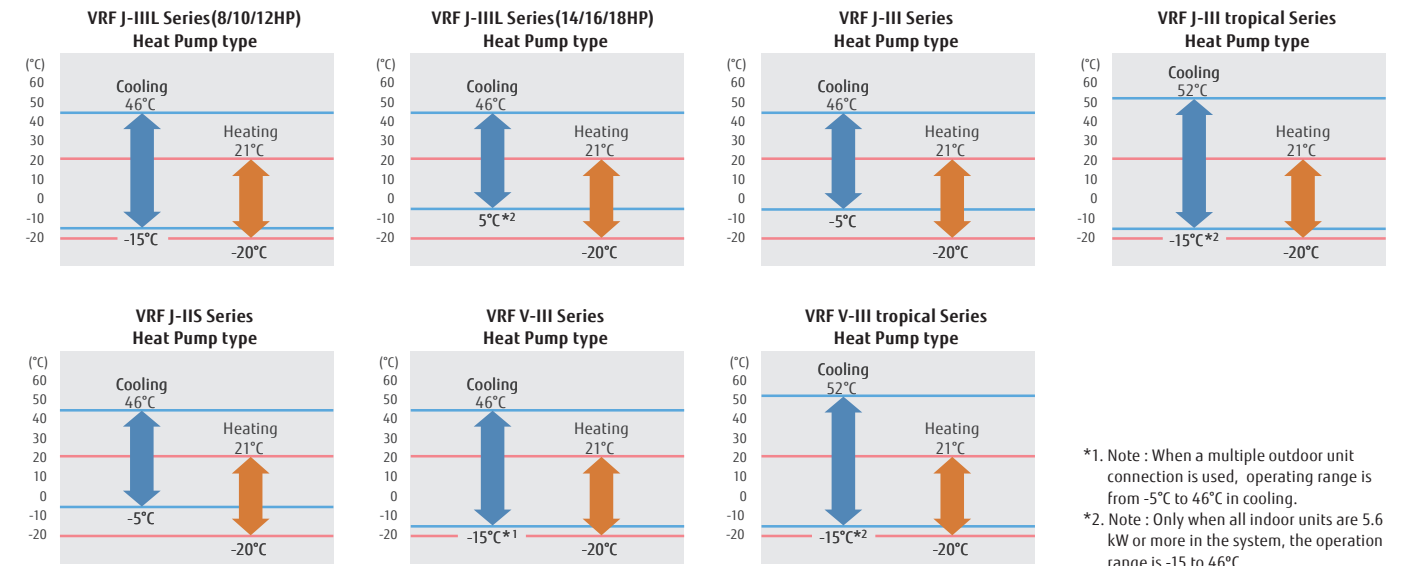

EASY INSTALLATION



Easily transported

Easily craned using lifting belt hooks

Design of outdoor unit allows for lifting straps to be used

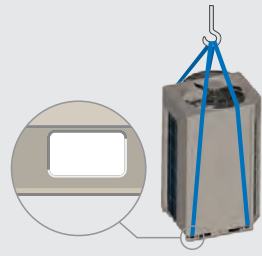

Transporting by forklift

Transport with forklift is possible.

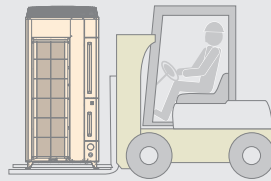

Can be transported in a small elevator



Easy access

By adopting a L-Shape front panel that can be removed, the work space for installation and service has been significantly expanded by this new design. For multiple installations, work is performed easily and efficiently even in a narrow space.

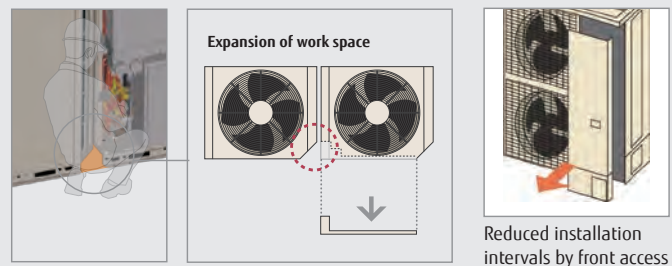

Flexible piping connection

Piping and wiring are available to the front, left and right, and bottom.

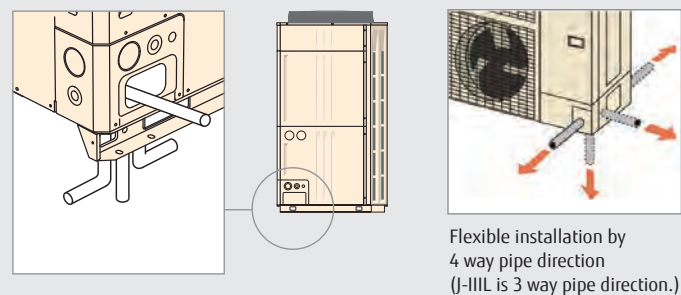

Simple wiring work

Installation of the wiring systems is made easier as the communication wiring can be installed continuously between the indoor and outdoor.

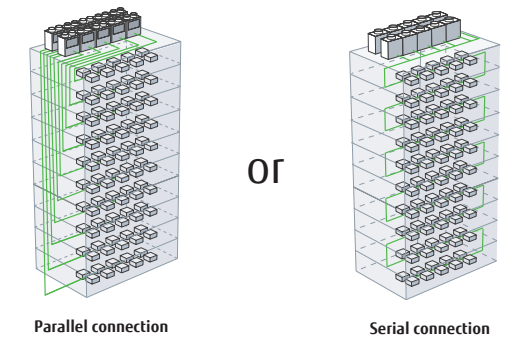

Easy evacuation - using vacuum mode function

The vacuum mode function enables all expansion valves of indoor units to be fully opened, making it easy to evacuate all the air inside pipe lines and indoor units.

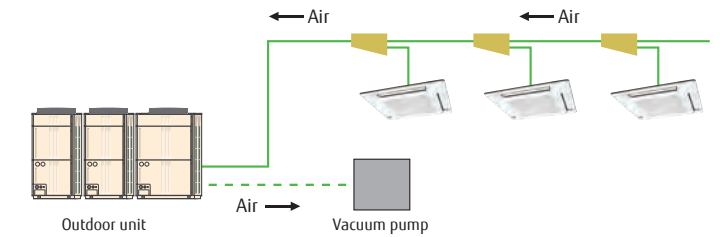

Automatic address setting

The address of the indoor unit and signal amplifier can be set through the automatic function setting on the outdoor unit PCB.

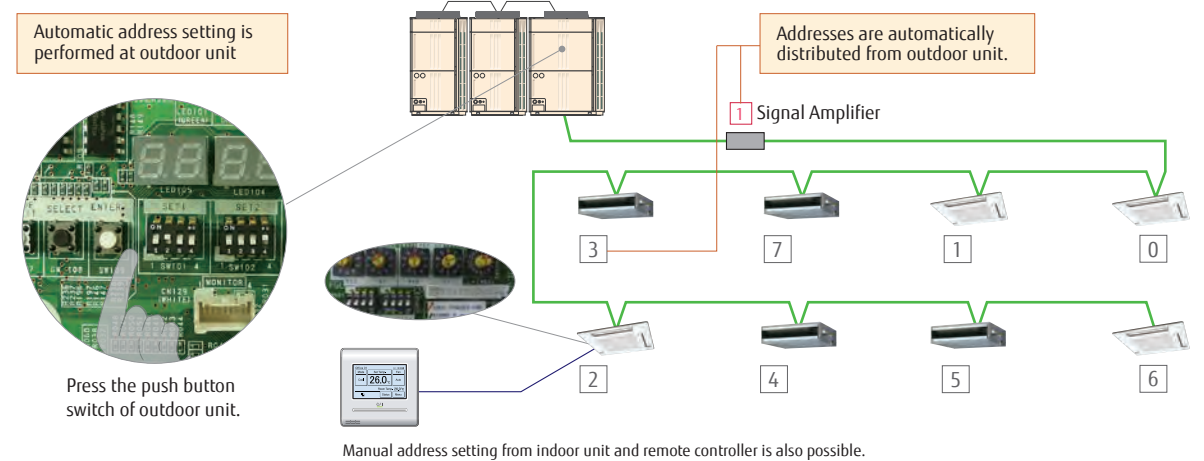

Easy commissioning by Service Tool

Service tools can be used to check the refrigerant temperature, pressure, and the operating status of the electronic expansion valve, making it easy to determine whether the units are connected properly.



EASY SERVICE & MAINTENANCE



Design for Easy Maintenance

7 segment LED is used to make it easy to check the details about the function setting status, refrigerant temperature, pressure, compressor operation time, and other factors for each model to make it easy to perform self-diagnostics.



Easy to read 7-segment LED : Confirm detailed operational and error status without using any specific equipment.

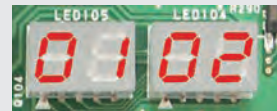

7-segment LED

- Operation mode status
- Discharge temperature/Pressure status
- Compressor operation indication
- Address/type/number of outdoor unit

Movable PCB panel
Easier for maintenance work behind the PCB

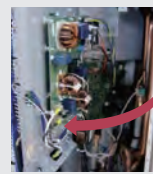

Error status can be checked easily via the indoor unit wired controller

An error code is displayed on a liquid crystal screen.

Wired Remote Controller

Simple Remote Controller

Wired Remote Controller (Touch panel)

No.	Date	Time	Address	Code
1	2012/ 8 / 1	11:00AM	002-01	141
2	2012/ 7/30	2:53AM	002-02	143
3	2012/ 7/28	10:53AM	002-02	142
4	2012/ 7/23	11:00AM	002-01	141
5	2012/ 7/22	11:00AM	002-01	141
6	2012/ 7/21	11:00AM	002-01	141

Error status can be checked easily by outdoor unit display

Error and quantity annunciation

Error code

Abnormal indoor unit address

Error diagnosis by Service Tool

Connection to Service Tool

- Detail operation status and recent error history can be checked and analyzed by using the Service Tool.
- Last 5 min. operation memory can be also be recorded.

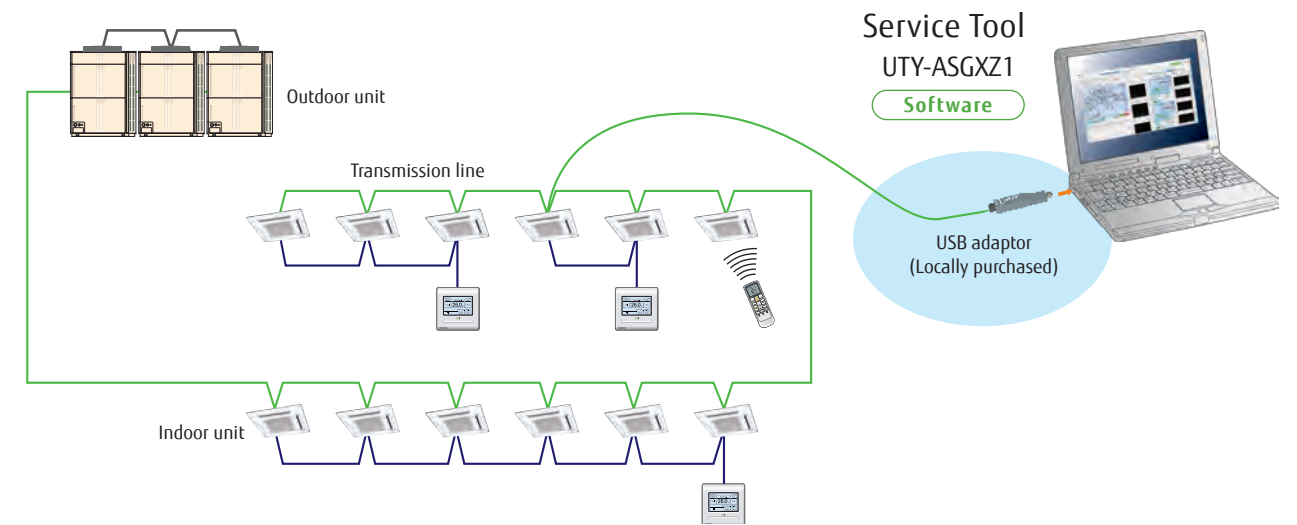

Remote monitoring

The Web Monitoring system allows you to view system operation anytime over the internet, ensuring issue free operation. The operating VRF network system in the building can be monitored real time over the Internet.

Monitoring Side

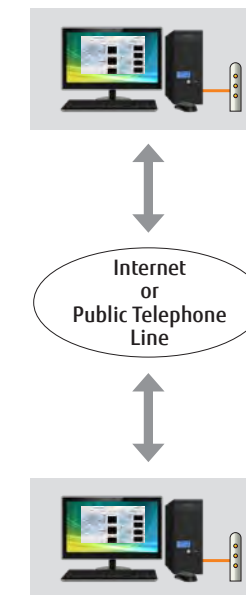

VRF Network System Side

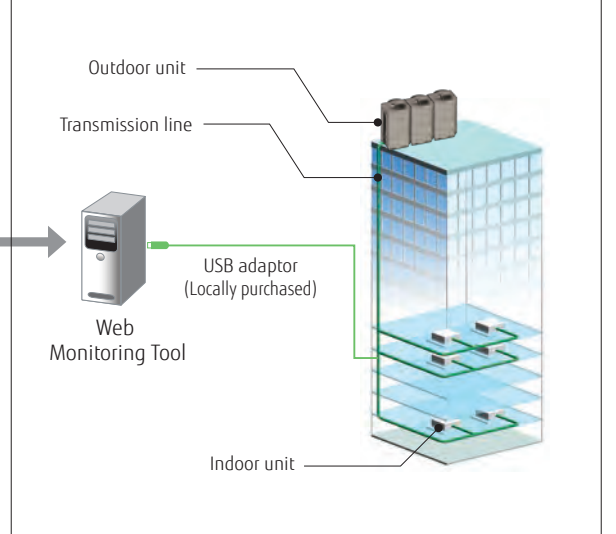

VRF SERIES

The VRF 6 Series has a total of 99 models to meet the environmental and building size requirements.

The VRF Series outdoor units were developed with structural designs and advanced inverter technology to provide higher efficiency. High durability technology has also been incorporated to ensure long-term use.

VRF Series LINE-UP

HEAT PUMP TYPE VRF J-III L Series

HEAT PUMP TYPE VRF J-III Series

HEAT PUMP TYPE VRF J-III TROPICAL Series

HEAT PUMP TYPE VRF J-IIS Series

HEAT PUMP TYPE VRF V-III Series

HEAT PUMP TYPE VRF V-III TROPICAL Series



HEAT PUMP TYPE VRF J-III L Series

Fujitsu General provides air conditioning systems for a wide range of applications from small office buildings and stores to large houses.

System Outline

Compact Outdoor unit

The compact and low sound level enable the units to be installed to various environment with restriction and/or limited spaces such as mechanical rooms and or rooftops.

Small room application

Up to 34 indoor units can be connected by the optimum heat exchanger structure. Available to various small rooms.

Quiet design

Top class low sound operation has been achieved. This allows installation of the units to various places without a special sound prevention work.

Small Office



System configuration example

- This system is used for small and medium-sized buildings. 1 refrigerant system is used for each outdoor unit.
- Connection of multiple indoor units using separation tubes and headers.

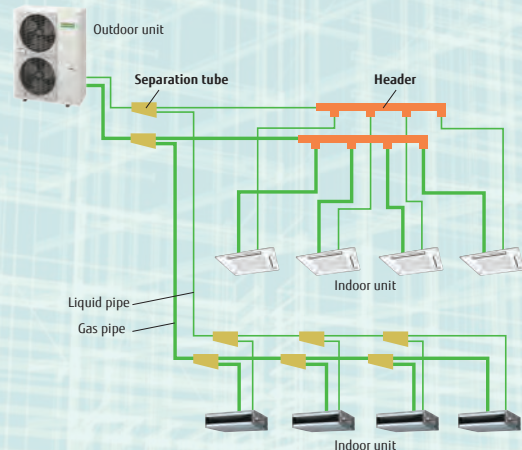

Features

Efficiency in actual operation

Top class high EER/COP is achieved for all models by large heat exchanger, high efficient DC twin compressor, and our own technologies.

High EER / COP

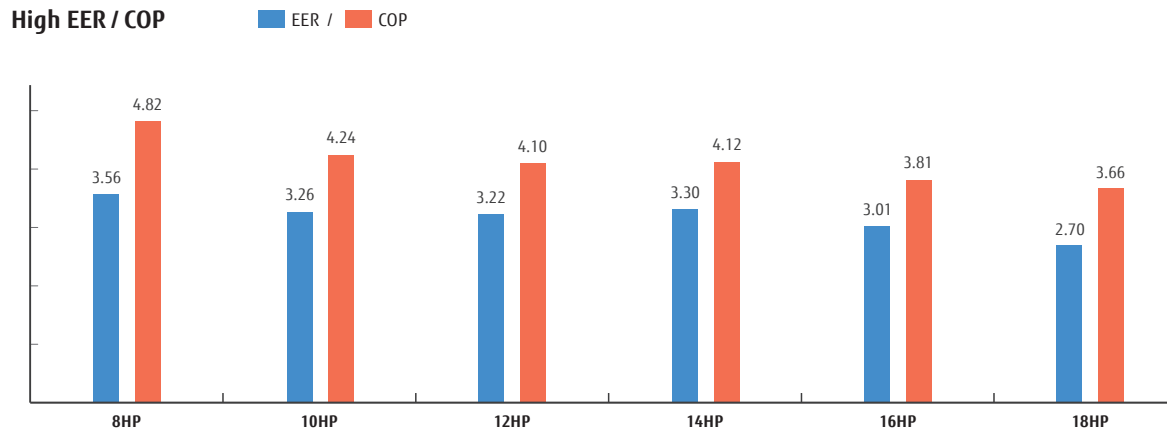

Advanced high efficiency technology



Ø570mm

Large propeller fan

The high efficiency and the low sound operation are mutually realized by reduction of a draft loss which are enabled by the Fujitsu General's original blade design and a large diameter propeller fan.



DC fan motor

Miniaturized, low noise, high efficiency, multi-stage DC fan motor is mounted.

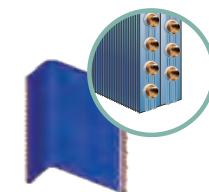

Large heat exchanger

Heat exchange performance is substantially improved by mounting of 2.6-row large heat exchanger.



DC inverter control

Efficiency is improved by mounting of new active filter module.



Subcool heat exchanger

Cooling performance is improved by mounting of dual tube heat exchanger.

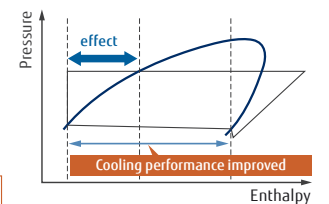

Scroll compressor

The equipment of scroll compressor with a wide range of rotational frequency from 15 to 130 rps together with Fujitsu General's unique sensorless sine wave control method which smoothly control the input power run into the motor realized a mutual improvement on the energy efficient operation and the low sound operation.

*18HP only

15-130 rps*





Fujitsu General provides perfect total air conditioning systems that take into account energy saving, low noise, comfortable airflow, small room application and centralized control for small-sized office buildings with many small rooms.

VRF J-III L

Image: 8/10/12 HP models

Slim & Compact Design



Various Installation

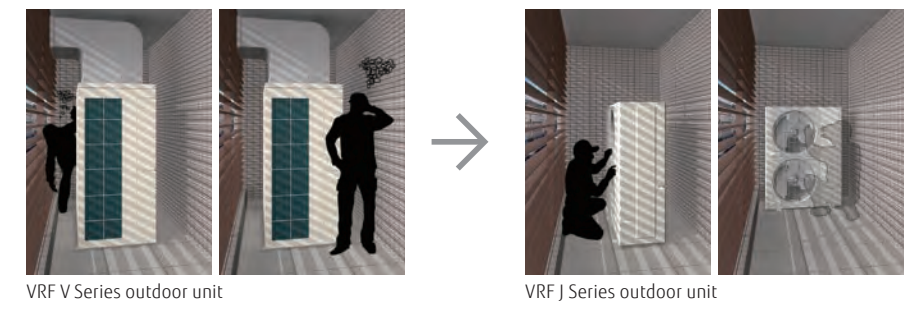

In house installation
Low noise in consideration for the nearby residents
 This model is front blow type and about 1000 mm wide, so flexible installation is possible even at narrow in house space.



Narrow space behind building
Space saving
 Due to compact and thin model, direct ground installation or wall mounted installation is possible even at narrow off-street.

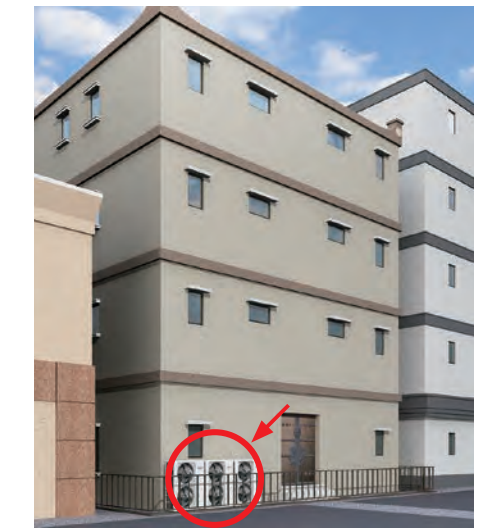

Installation at back street of building
Flexible installation
 This model is front blow type and slim & low body, so installation space is compact. Building windows are not blocked and space saving multiple units installation is possible.

VRF SERIES

Long piping capability

Our advanced refrigerant control technology allows us to achieve a total refrigerant piping length of 400 m. This opens up new possibilities in system design.

Total pipe length
400 m maximum

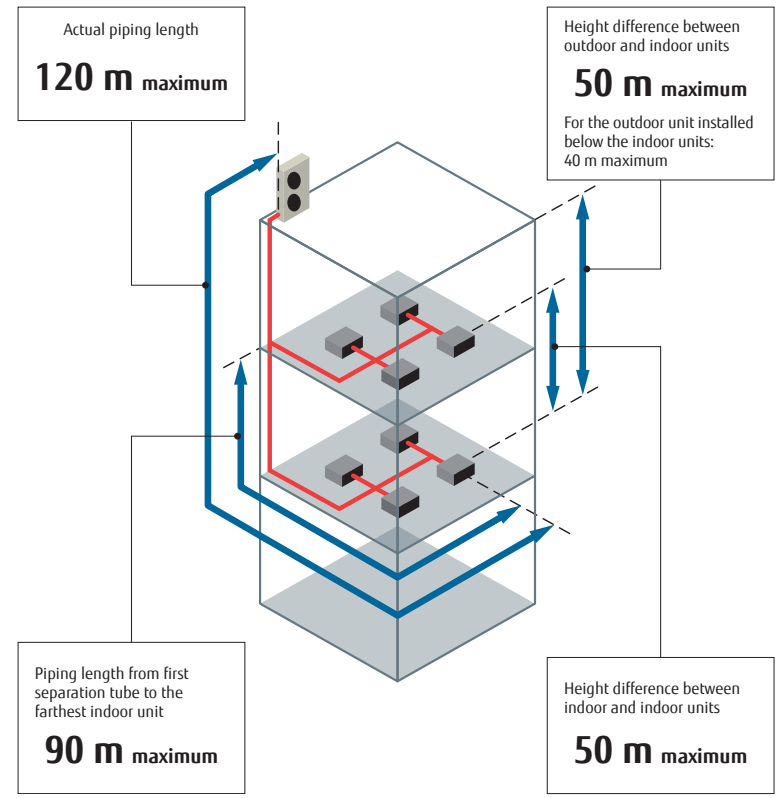

Up to 34 units* can be connected

The combination of the smallest but adequate capacity indoor unit and a new outdoor unit with the optimum heat exchanger structure has realized the industry's top class connection of 34 units.

*: 18HP model

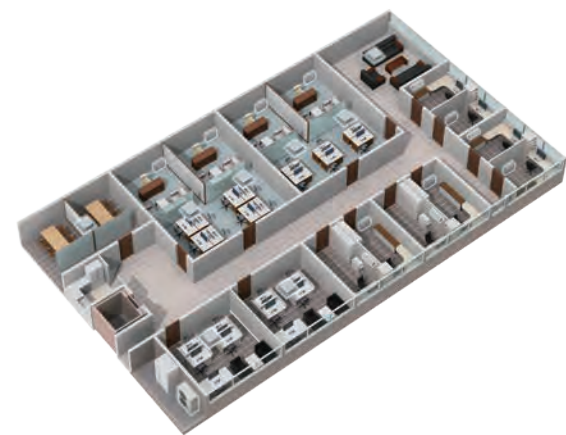

Specifications

Rating Capacity range	HP	8	10	12	14	16	18		
Model name		AJH072LELAH	AJH090LELAH	AJH108LELAH	AJH126LELAH	AJH144LELAH	AJH162LELAH		
Maximum Connectable Indoor Unit		1-15	1-19	1-22	1-27	1-30	1-34		
Power source		3 phase, ~400V, 50Hz							
Capacity	Cooling	kW		22.4	28.0	33.5	40.0	45.0	50.0
	Heating	kW		22.4	28.0	33.5	40.0	45.0	50.0
Input power	Cooling	kW		6.30	8.59	10.42	12.12	14.96	18.52
	Heating	kW		4.65	6.61	8.18	9.71	11.81	13.66
EER	Cooling	W/W		3.56	3.26	3.22	3.30	3.01	2.70
COP	Heating	W/W		4.82	4.24	4.10	4.12	3.81	3.66
Air flow rate		m ³ /h		8,400	9,000	11,000	13,000	14,000	14,800/15,300
Sound pressure level / Power level	Cooling	dB (A)		52 / 66	54 / 69	59 / 73	62 / 75	64 / 77	65 / 79
	Heating	dB (A)		54 / -	57 / -	61 / -	63 / -	65 / -	68 / -
Dimensions	Height	mm		1,428	1,428	1,428	1,638	1,638	1,638
	Width	mm		1,080	1,080	1,080	1,080	1,080	1,080
	Depth	mm		480	480	480	480	480	480
Weight		kg		170	177	178	213	213	217
	Type (Global Warming Potential)	R410A (2,088)		R410A (2,088)	R410A (2,088)	R410A (2,088)	R410A (2,088)	R410A (2,088)	R410A (2,088)
Refrigerant	Charge	kg(CO2eq-T)		7.0 (14.6)	7.5 (15.7)	7.5 (15.7)	11.0 (22.9)	11.0 (22.9)	11.8 (24.6)
	Connection pipe diameter	Liquid	mm		9.52	9.52	12.70	12.70	12.70
	Gas	mm		19.05	22.20	28.58	28.58	28.58	28.58
Total pipe length		m		400	400	400	400	400	400
Max. Height difference		m		50/40 (Outdoor unit: Upper/Lower)					
Operating range	Cooling	°C		-15 to 46	-15 to 46	-15 to 46	-5 to 46*	-5 to 46*	-5 to 46*
	Heating	°C		-20 to 21	-20 to 21	-20 to 21	-20 to 21	-20 to 21	-20 to 21

Note : Specifications are based on the following conditions.
Cooling : Indoor temperature of 27°CDB / 19°CWB, and outdoor temperature of 35°CDB / 24°CWB.
Heating : Indoor temperature of 20°CDB / (15°CWB), and outdoor temperature of 7°CDB / 6°CWB.
Pipe length : 7.5 m; Height difference between outdoor unit and indoor unit : 0 m.
* The cooling operation range of -15 to 46°C is allowed only when all of the indoor units connected to the system are higher than capacity of 5.6 kW.

External static pressure

External static pressure is available up to 60 Pa for 14/16/18HP. (20 Pa for 8HP, 30Pa for 10/12HP)



Top Class Low Operating Sound

Top class low operating sound is realized. Highly suited to densely populated areas thanks to their low operating sound.

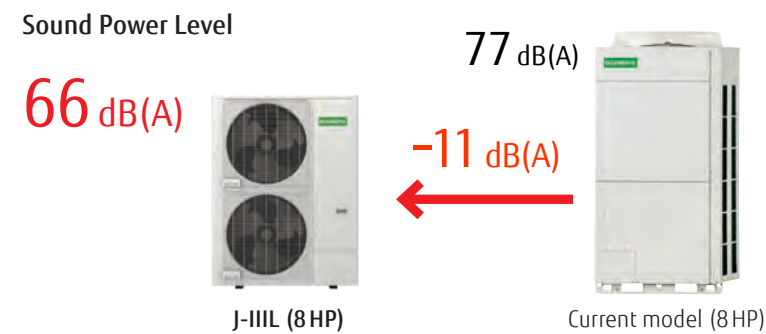

Dimensions

Models : AJH072LELAH / AJH090LELAH / AJH108LELAH

Models : AJH126LELAH / AJH144LELAH / AJH162LELAH (Unit : mm)

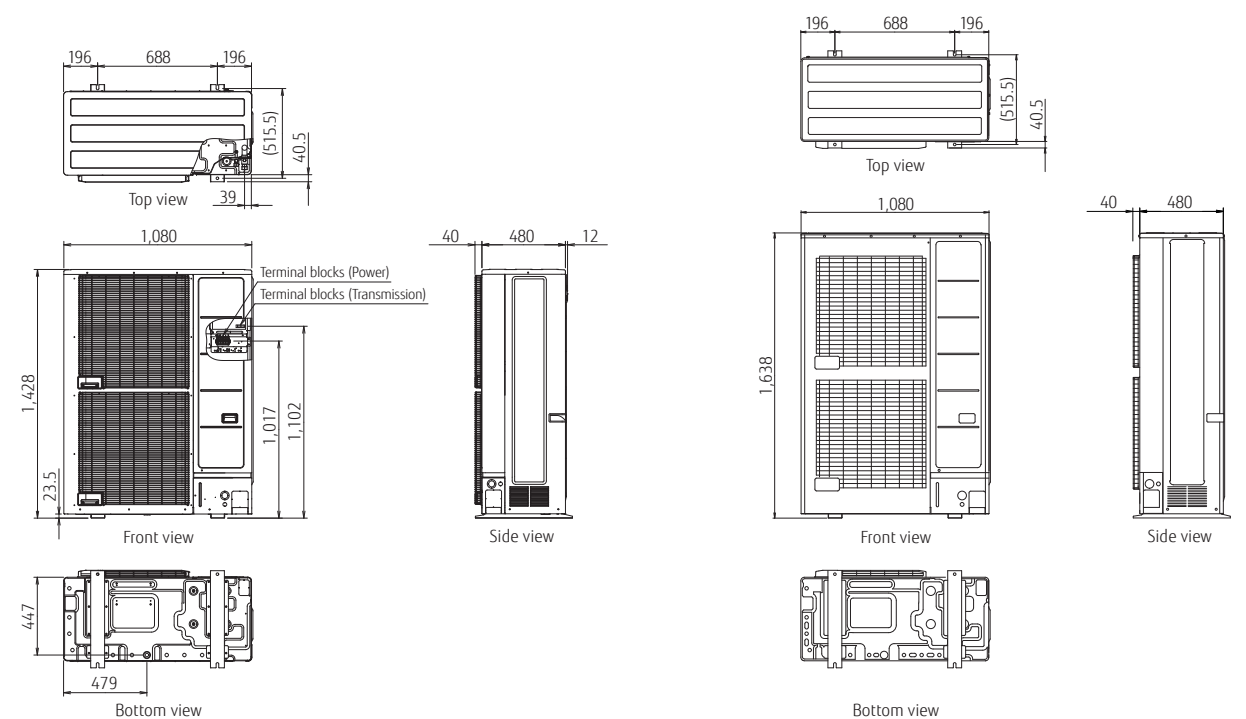

HEAT PUMP TYPE

VRF J-III Series

Fujitsu General provides air conditioning systems for a wide range of applications from small office buildings and stores to large houses.

System Outline

High Energy Efficiency

Heat pump inverter control is used to achieve an efficient cooling and heating operation in any indoor unit combination.

Flexible systems for small- and medium-size buildings air conditioning

Space saving design and long piping design allow for flexible installation on the roofs or balconies of small- and medium-size buildings. Multiple indoor units of various capacities and types can be connected.

Small Office

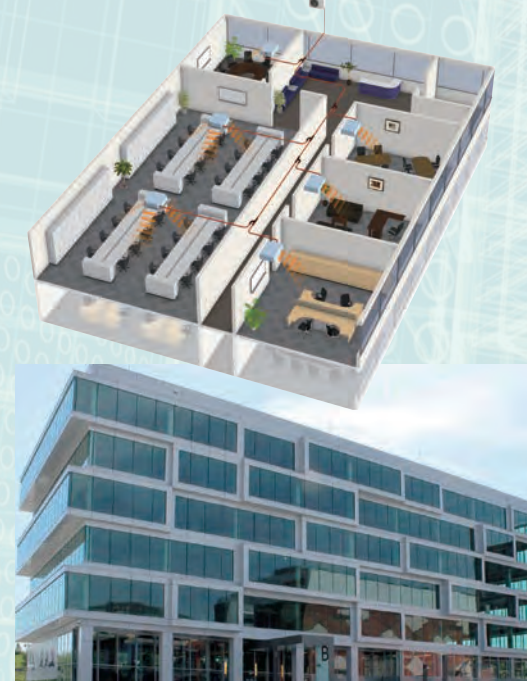

System configuration example

- This system is used for small and medium-sized buildings. 1 refrigerant system is used for each outdoor unit.
- Connection of multiple indoor units using separation tubes and headers.

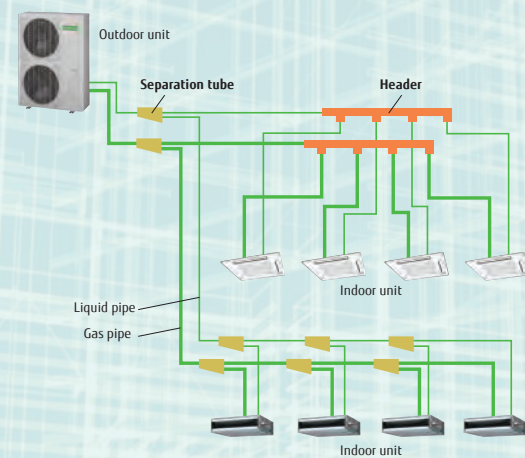

Features

Efficiency in actual operation

Top class high COP is achieved for all models by large heat exchanger, high efficient DC twin compressor, and our own technologies.

High EER / COP

■ EER / ■ COP

[3 phase]

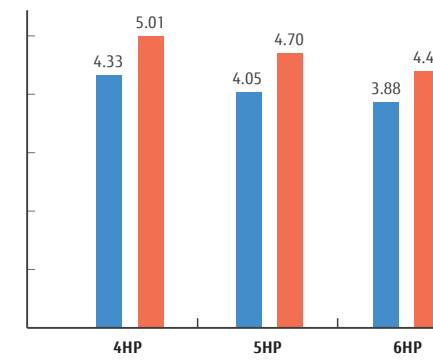

[Single phase]

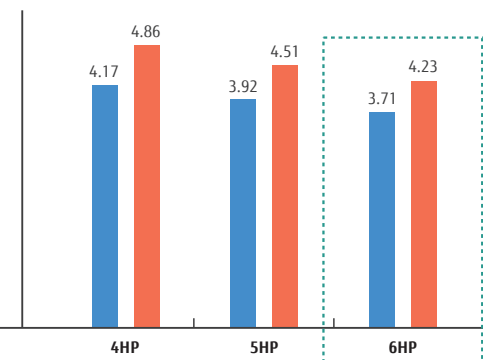

6HP class

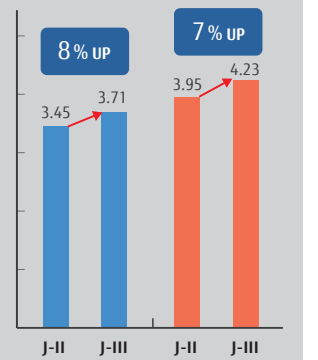

Advanced high efficiency technology



Large propeller fan

High performance and low noise realized by large propeller and optimization of angle.



DC fan motor

Miniaturized, low noise, high efficiency, multi-stage DC fan motor is mounted.

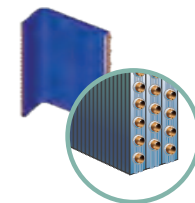

Large heat exchanger

Heat exchange performance is substantially improved by mounting of 3-row large heat exchanger.



DC inverter control

Efficiency is improved by mounting of new active filter module.



Subcool heat exchanger

Cooling performance is improved by mounting of dual tube heat exchanger.

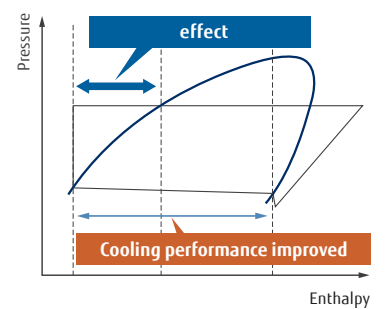

High efficiency compressor motor

Optimized refrigerant flow design

Highly accurate parts

DC twin rotary compressor

Efficiency in all load regions is good. Especially good performance from low to medium at normal operation.

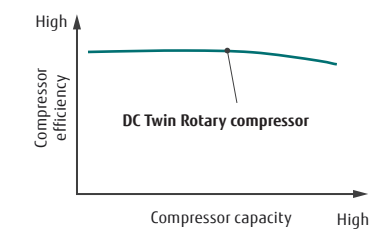

HEAT PUMP TYPE

VRF J-III Tropical Series



Fujitsu General provides air conditioning systems for a wide range of applications from small office buildings and stores to large houses.

System Outline

High ambient operation design

Possible to operate cooling up to 52°C outdoor temperature

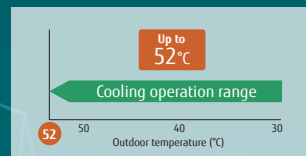

Powerful cooling capacity design

Keeping high cooling power at even high ambient temperature

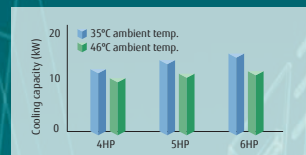

Anti-corrosion treatment design

All metallic and PCB components are protected against corrosion



Small Office

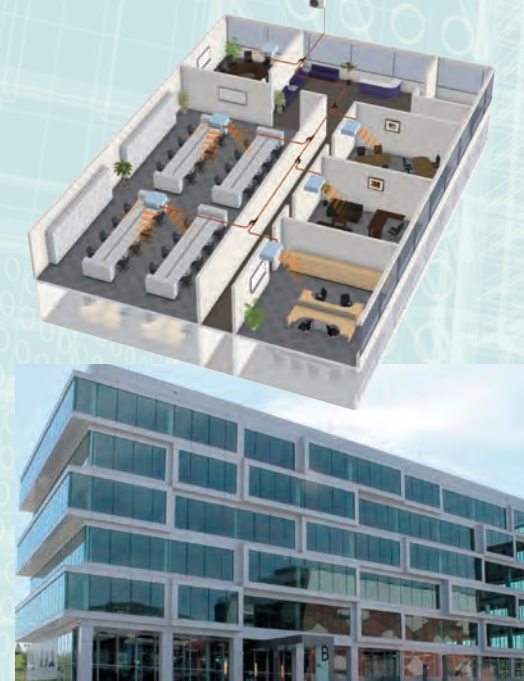

System configuration example

- This system is used for small and medium-sized buildings. 1 refrigerant system is used for each outdoor unit.
- Connection of multiple indoor units using separation tubes and headers.

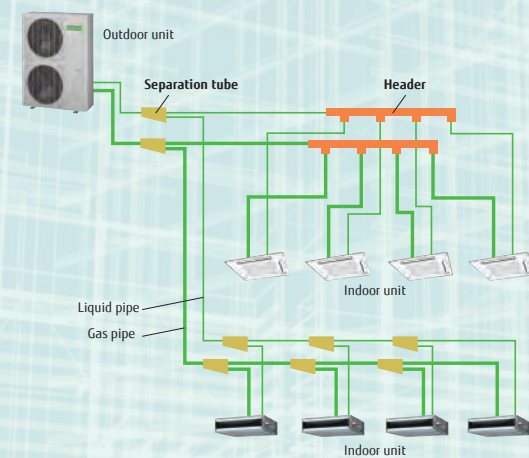

Features

Energy efficiency

Top class high COP is achieved for all models by large heat exchanger, high efficient DC twin compressor, and our own technologies.

High EER / COP

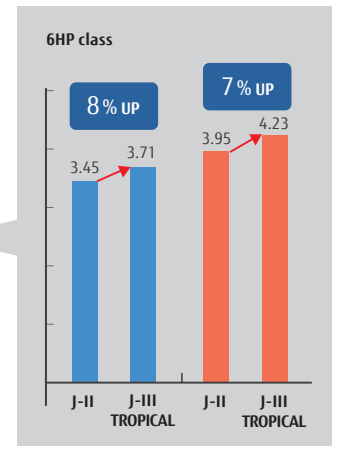
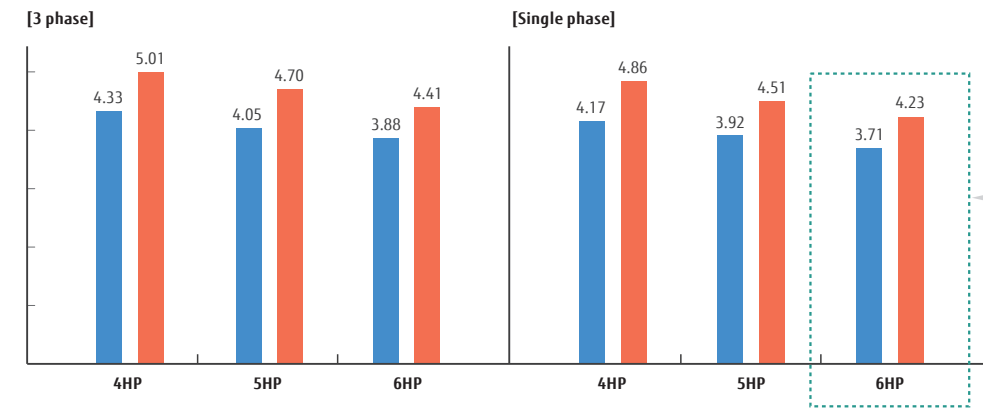

Advanced high efficiency technology



Large propeller fan

High performance and low noise realized by large propeller and optimization of angle.

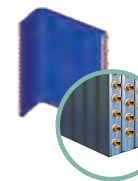

Large heat exchanger

Heat exchange performance is substantially improved by mounting of 3-row large heat exchanger.



Subcool heat exchanger

Cooling performance is improved by mounting of dual tube heat exchanger.

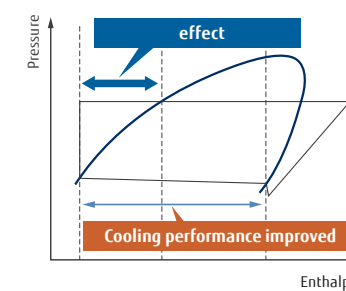

All Inverter



INVERTER control PCB

Efficiency is improved by mounting of new active filter module.



INVERTER fan motor

Miniaturized, low noise, high efficiency, multi-stage DC fan motor is mounted.



INVERTER Compressor

Efficiency in all load regions is good. Especially good performance from low to medium at normal operation.

Made in JAPAN

Long piping capability

Our advanced refrigerant control technology allows us to achieve a total refrigerant piping length of 180 m. This opens up new possibilities in system design.

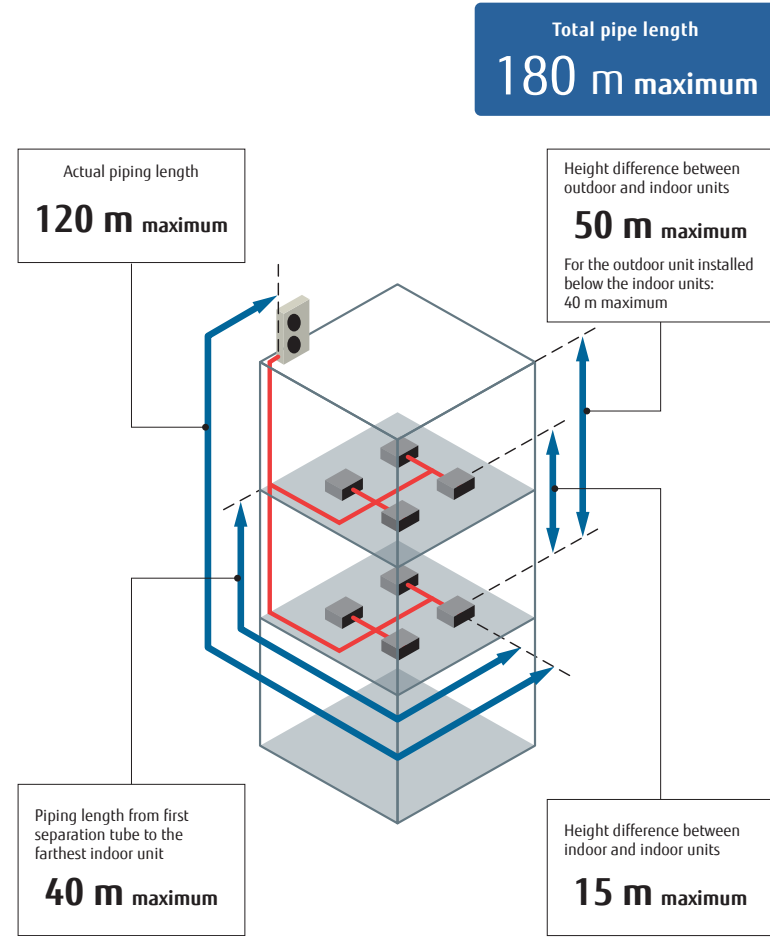
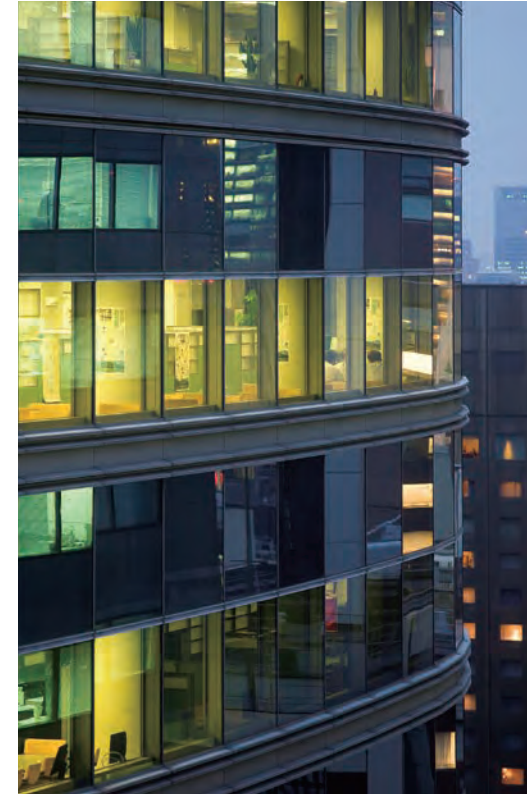

Non-stop oil recovery operation

A comfortable room condition is maintained during oil recovery mode because the product continues to operate without stopping the cooling or heating operation.

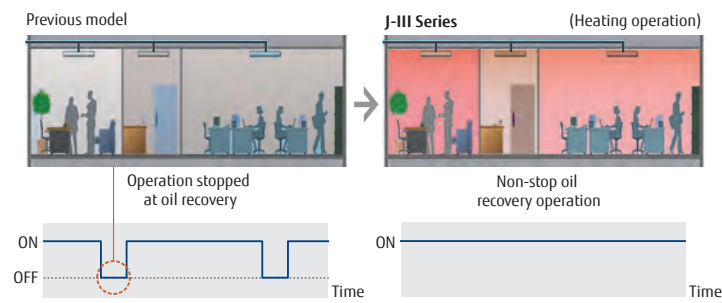

Easier Installation

Connection check function : Possible to confirm whether wiring connection and address setting are correct by a quick check run function.

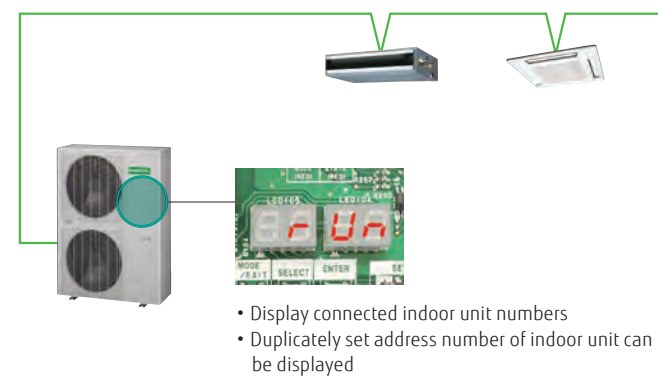

Specifications

Rating Capacity range	HP	4	5	6	4	5	6
Model name		AJH040LBTAHN	AJH045LBTAHN	AJH054LBTAHN	AJH040LETAHN	AJH045LETAHN	AJH054LETAHN
Maximum Connectable Indoor Unit		1-7	1-8	1-9	1-7	1-8	1-9
Power source		Single phase, ~230V, 50Hz			3 phase, ~400V, 50Hz		
Capacity	Cooling(T1/T3)	kW	12.1/10.3	14.0/11.1	15.5/11.5	12.1/10.3	14.0/11.1
	Heating	kW	13.6	16.0	18.0	13.6	16.0
Input power	Cooling(T1/T3)	kW	2.90/3.47	3.57/3.77	4.18/3.92	2.79/3.30	3.46/3.57
	Heating	kW	2.80	3.55	4.26	2.71	3.40
Current	Cooling(T1/T3)	A	12.7/15.2	15.7/16.6	18.4/17.2	5.2/6.2	6.6/6.6
	Heating	A	12.3	15.6	18.7	5.0	6.5
EER	Cooling(T1/T3)	W/W	4.17/2.97	3.92/2.95	3.71/2.94	4.33/3.13	4.05/3.11
COP	Heating	W/W	4.86	4.51	4.23	5.01	4.70
Air flow rate	High	m³/h	6,200	6,400	6,900	6,200	6,400
	Cooling	m³/h	50	51	53	50	51
Sound pressure level	Heating	dB (A)	52	53	55	52	53
	Height	mm	1,334	1,334	1,334	1,334	1,334
Net Dimensions	Width	mm	970	970	970	970	970
	Depth	mm	370	370	370	370	370
	Net Weight	kg	120	120	120	120	120
Refrigerant	Type		R410A	R410A	R410A	R410A	R410A
Connection pipe diameter	Liquid	mm	9.52	9.52	9.52	9.52	9.52
	Gas	mm	15.88	15.88	19.05	15.88	15.88
Operating range	Cooling	°CDB	-5 to 52	-5 to 52	-5 to 52	-5 to 52	-5 to 52
	Heating	°CDB	-20 to 21	-20 to 21	-20 to 21	-20 to 21	-20 to 21

Note: Specifications are based on the following conditions.
Cooling(T1): Indoor temperature of 27°CDB / 19°CWB, and outdoor temperature of 35°CDB / 24°CWB
Cooling(T3): Indoor temperature of 29°CDB / 19°CWB, and outdoor temperature of 46°CDB / 24°CWB
Heating: Indoor temperature of 20°CDB / (15°CWB), and outdoor temperature of 7°CDB / 6°CWB.
Pipe length: 7.5m. Height difference between outdoor and indoor unit: 0m.

Dimensions

Models : AJH040LBTAHN / AJH045LBTAHN / AJH054LBTAHN / AJH040LETAHN / AJH045LETAHN / AJH054LETAHN

(Unit : mm)

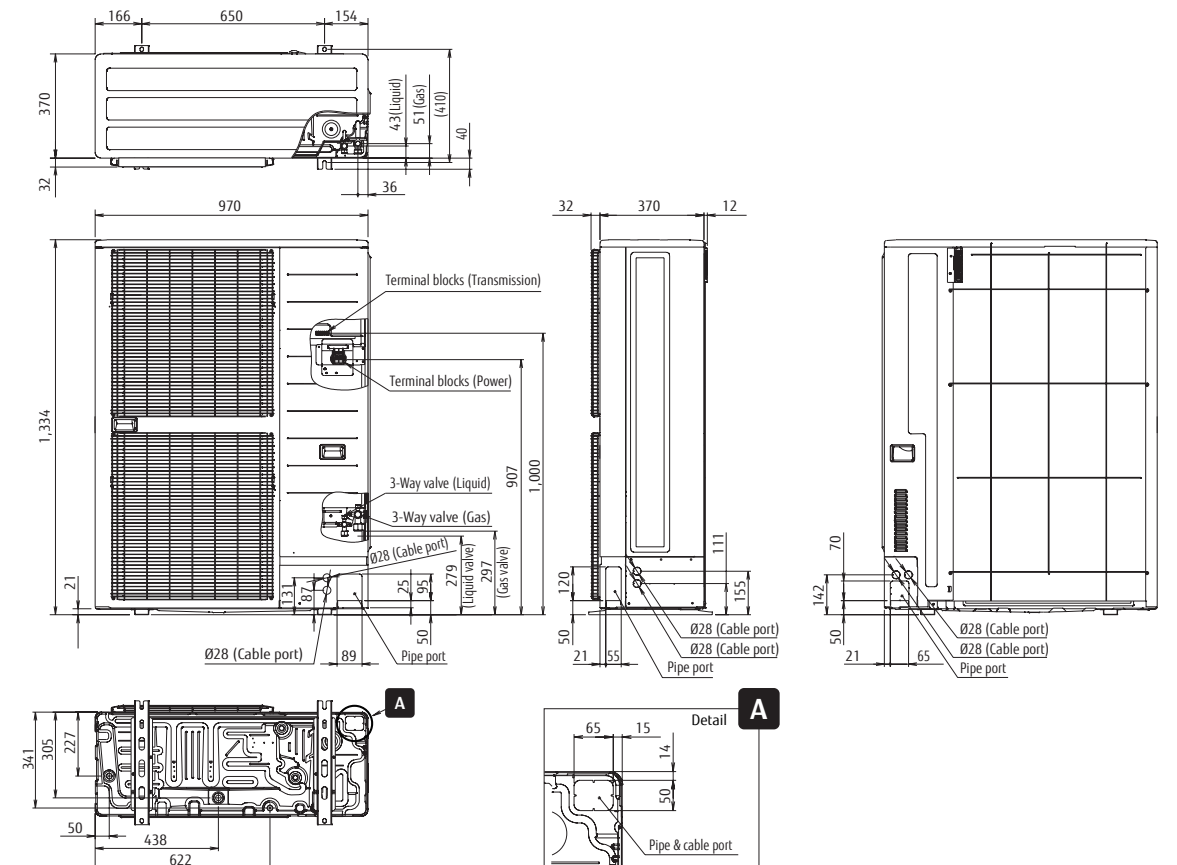

HEAT PUMP TYPE VRF J-IIS Series

Fujitsu General provides air conditioning systems for a wide range of applications from small office buildings and stores to large houses.

System Outline

Space saving and low sound level design

Economical individual air conditioning is realized by ALL-DC technology, large capacity DC twin rotary compressor, and 3-row heat exchanger though the size is compact.

Flexible systems for homes, shops, small-size buildings air conditioning

Due to compact size design and flexible piping design, J-IIS series can be installed easily at the place where the installation space is limited such as homes, shops, and small offices. Multiple indoor units of various capacities and types can be connected.

Large Homes



System configuration example

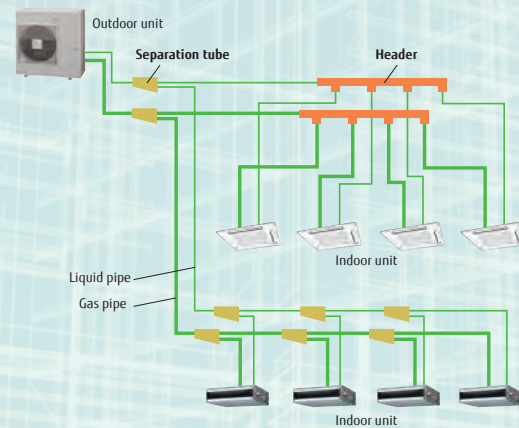

Features

It Can be Easily Carried and Installed Obscure Place

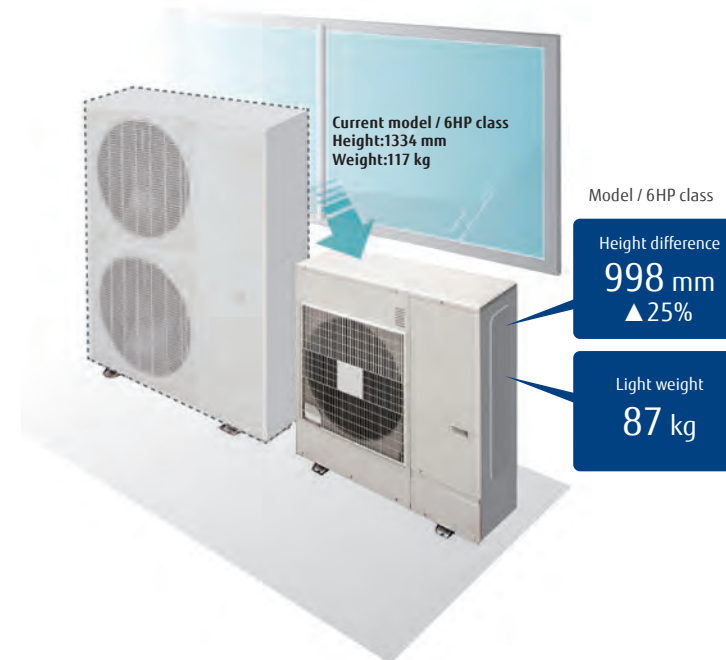

Small and light weight outdoor unit

This model is much more compact than conventional 6HP comparable outdoor units. Even when installed on the balcony it fits within the height of the fence. The compact size with a height of less than 1 m allows it to be installed under windows and in tight spaces

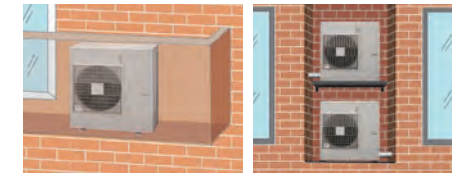

Low sound level design

Significantly low sound level is improved by using DC twin rotary compressor, inverter technology, and advanced airflow structure design.

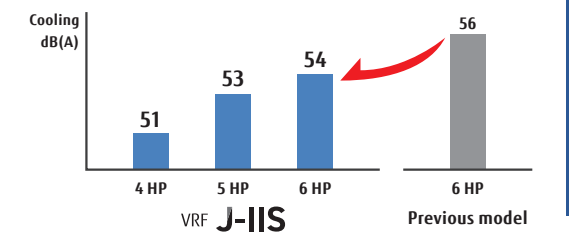

Advanced high efficiency technology



Large propeller fan
High performance and low noise realized by large propeller and optimization of angle.



DC fan motor
Miniaturized, low noise, high efficiency, multi-stage DC fan motor is mounted.

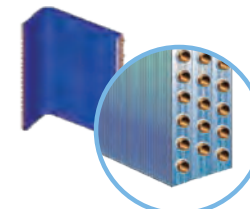

Large heat exchanger
Heat exchange performance is substantially improved by mounting of 3-row large heat exchanger.

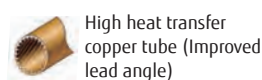

High heat transfer copper tube (Improved lead angle)



DC inverter control
Efficiency is improved by mounting of new active filter module.

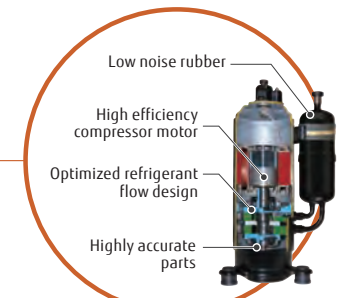

Compact and high performance DC twin rotary compressor

Efficiency in all load regions is good. Especially good performance from low to medium at normal operation.

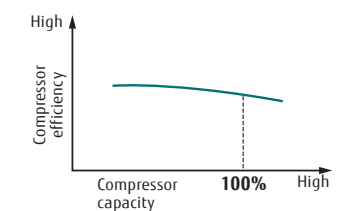

Smooth airflow grille
This grille was aerodynamically designed for good efficiency with little blow loss.



Long Piping Length

Our advanced refrigerant control technology allows us to achieve a total refrigerant piping length of 80 m. This opens up new possibilities in system design.

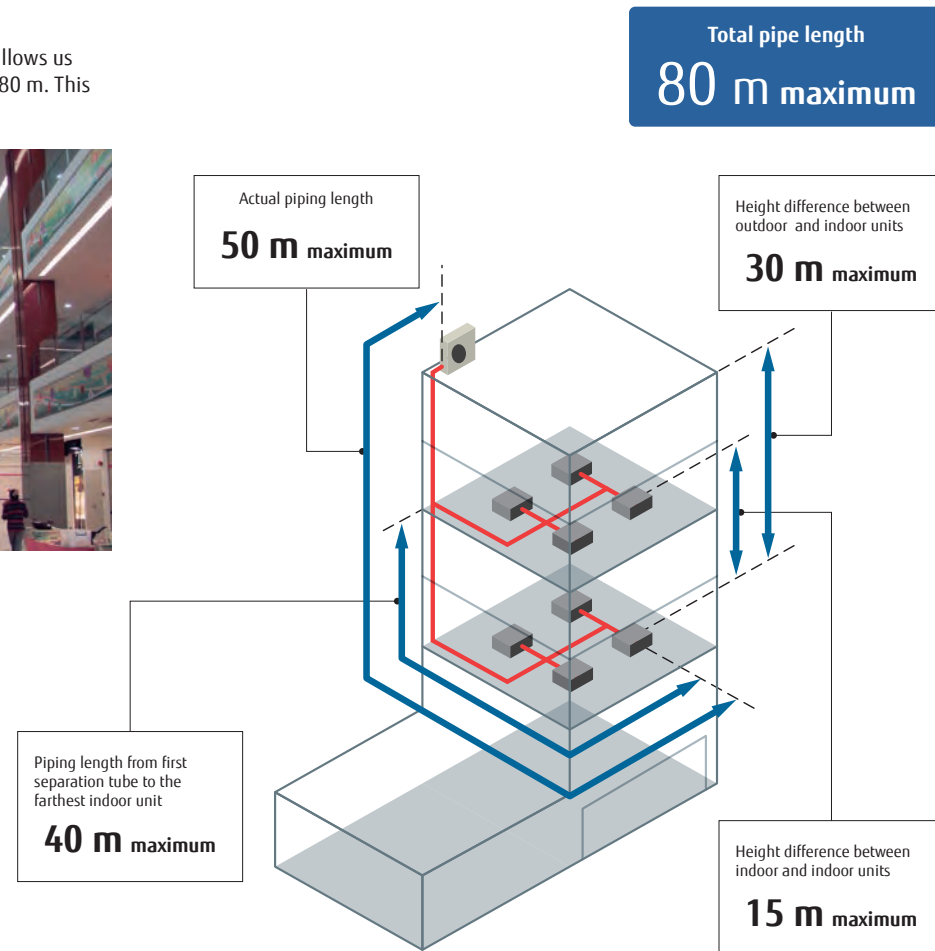

Non-stop oil recovery operation

A comfortable room condition is maintained during oil recovery mode because the product continues to operate without stopping the cooling or heating operation.

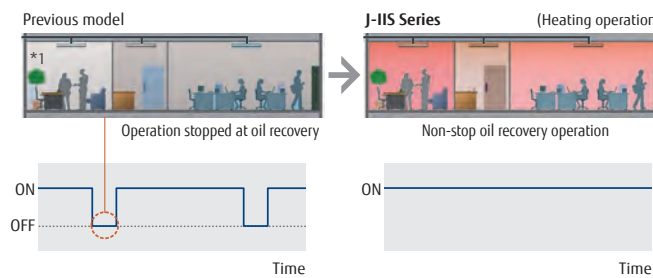

Easier Installation

Connection check function : Possible to confirm whether wiring connection and address setting are correct by a quick check run function.

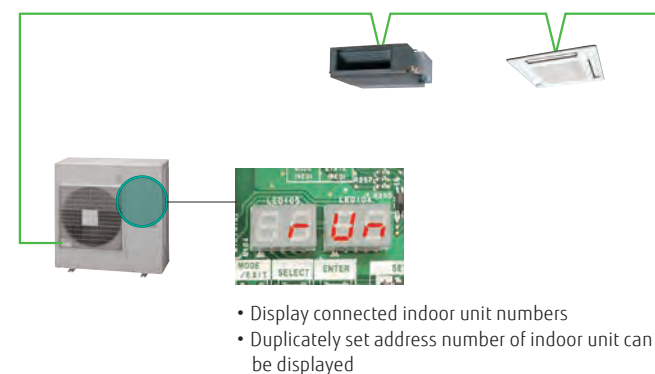

Specifications

Rating Capacity range		HP	4	5	6
Model name			AJH040LCLAH	AJH045LCLAH	AJH054LCLAH
Maximum Connectable Indoor Unit			7	8	8
Power source			Single phase, ~230V, 50Hz		
Capacity	Cooling	kW	12.1	14.0	15.1
	Heating	kW	13.6	16.0	16.5
Input power	Cooling	kW	3.44	4.43	5.03
	Heating	kW	3.09	3.93	4.11
EER	Cooling	W/W	3.52	3.16	3.00
COP	Heating	W/W	4.40	4.07	4.01
Air flow rate		m ³ /h	4,040	4,200	4,200
Sound pressure level / Power level	Cooling	dB (A)	51 / 67	53 / 69	54 / 70
	Heating	dB (A)	54 / 68	55 / 69	56 / 70
Heat exchanger fin			Blue fin	Blue fin	Blue fin
Dimensions	Height	mm	998	998	998
	Width	mm	970	970	970
	Depth	mm	370	370	370
Weight		kg	86	86	87
Refrigerant	Type (Global Warming Potential)		R410A (2,088)	R410A (2,088)	R410A (2,088)
	Charge	kg(CO ₂ eq-t)	4.0 (8.4)	4.0 (8.4)	4.0 (8.4)
Connection pipe diameter	Liquid	mm	9.52	9.52	9.52
	Gas	mm	15.88	15.88	15.88
Total pipe length		m	80	80	80
Max. Height difference		m	30	30	30
Operating range	Cooling	°C	-5 to 46	-5 to 46	-5 to 46
	Heating	°C	-20 to 21	-20 to 21	-20 to 21

Note : Specifications are based on the following conditions.
 Cooling : Indoor temperature of 27°CDB / 19°CWB, and outdoor temperature of 35°CDB / 24°CWB.
 Heating : Indoor temperature of 20°CDB / (15°CWB), and outdoor temperature of 7°CDB / 6°CWB.
 Pipe length : 7.5 m; Height difference between outdoor unit and indoor unit : 0 m.
 The protective function may work when using it outside the operation range.

Dimensions

Models : AJH040LCLAH / AJH045LCLAH / AJH054LCLAH

(Unit : mm)

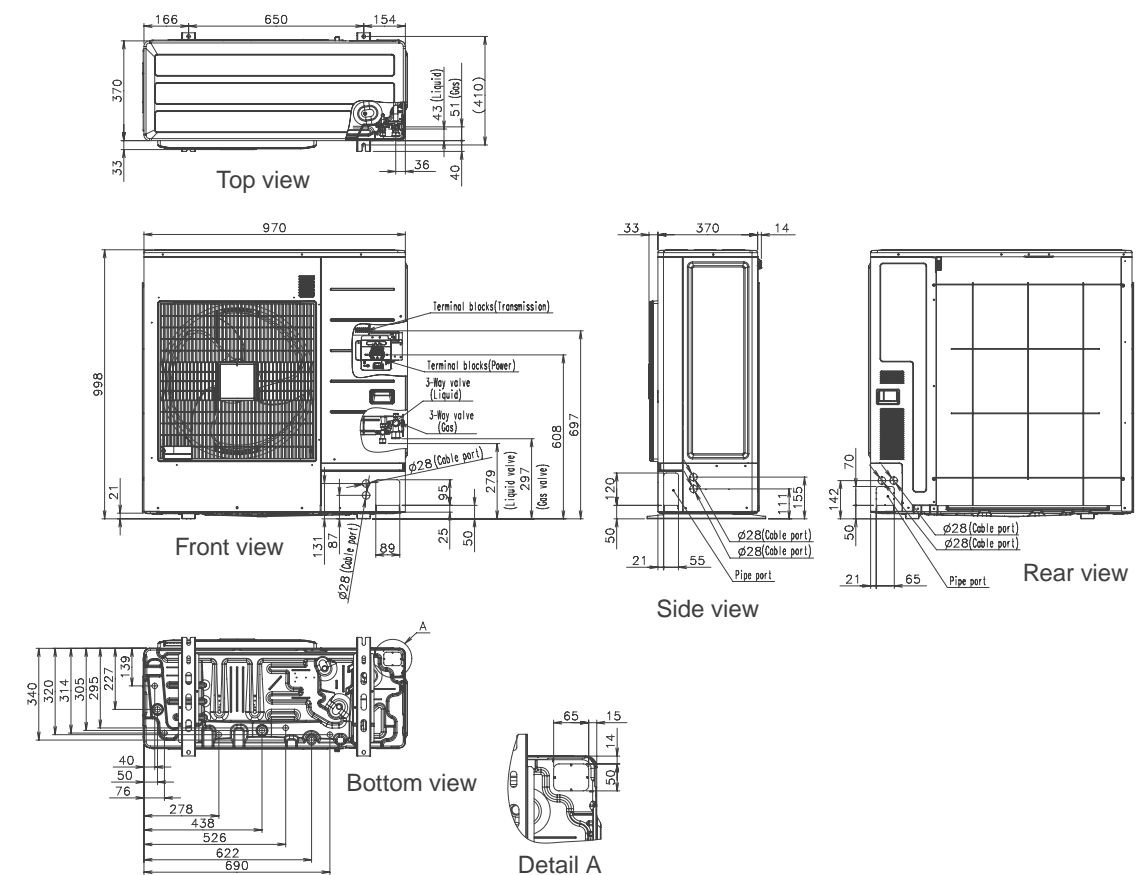

HEAT PUMP TYPE VRF V-III Series

Smart and cutting edge design
Extensive lineup from 8HP to 54HP in 2HP increment
Connectable indoor unit capacity ratio up to 150%

System Outline

Excellent energy saving

Heat pump inverter type realizes the highly energy saving air conditioning for individual cooling and heating operation by all inverter technology for seasonal efficiency.

High design flexibility for various building air conditioning

High design flexibly meets the various needs of high-rise building air conditioning such as outdoor unit roof top concentrated installation and each floor installation by large capacity combination, sufficient connection capacity, and high static pressure design.

Easy installation and maintenance

The flexible communication method and piping connections makes installation and maintenance easy even for large systems.

Large Office

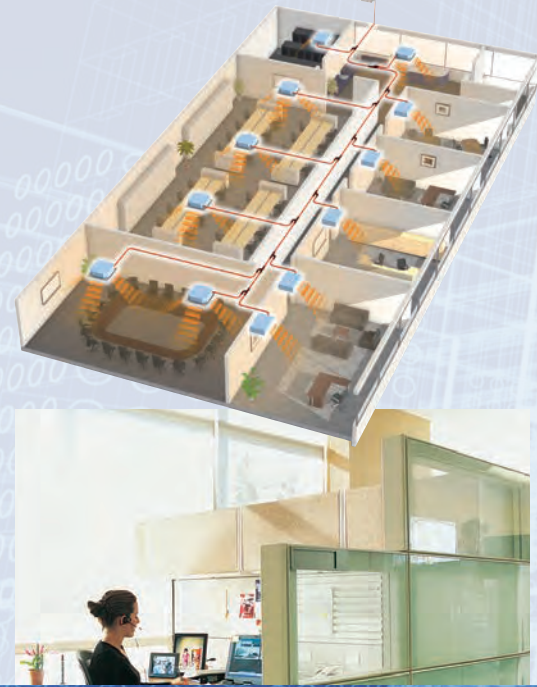

System configuration example

- This system is used for medium-sized and large buildings. Connecting each outdoor unit makes it possible to create a high-capacity system.
- Connection of multiple indoor units using separation tubes and headers.

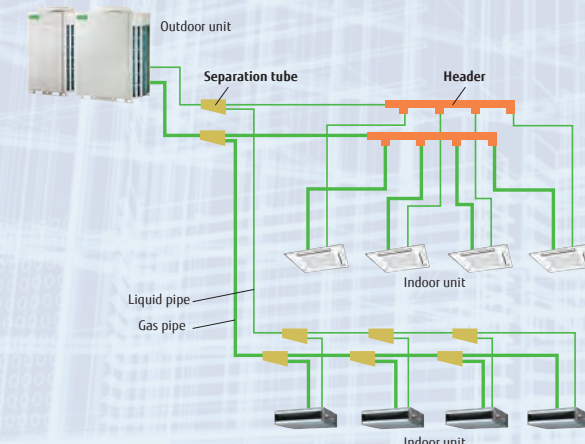

Features

New intelligent refrigerant control

Fujitsu General is proposing outdoor units equipped with refrigerant control function.

The refrigerant control operates with subtle control corresponding to the heat load of the room and offers a more comfortable environment. The refrigerant control can also provide increased energy savings.

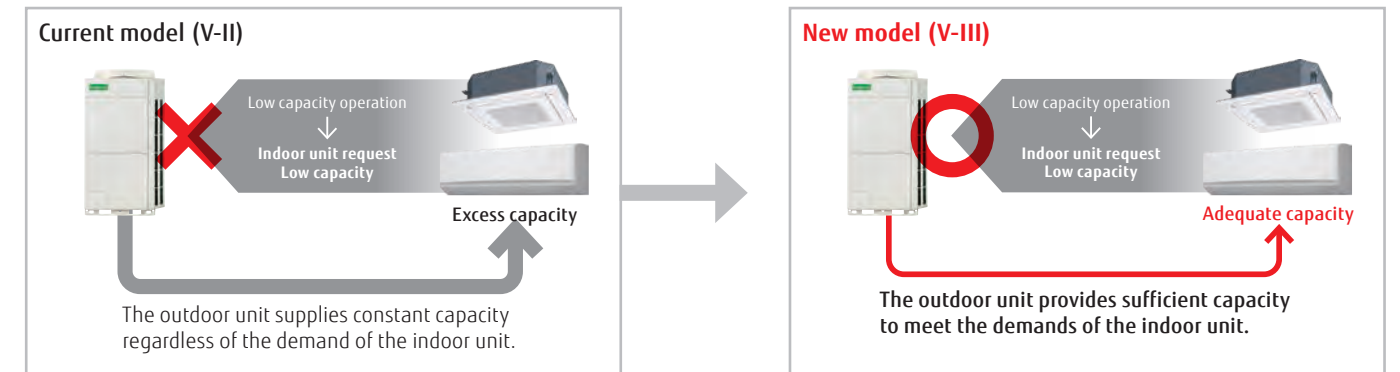

* The improvements due to the control and the actual sine wave vary depending on the combination of the indoor unit and system operating conditions.

Efficiency in actual operating conditions

Top class high COP is realized for all combinations by our unique heat exchanger structure, high efficient DC twin compressor, and other our own technologies.

Space saving combination

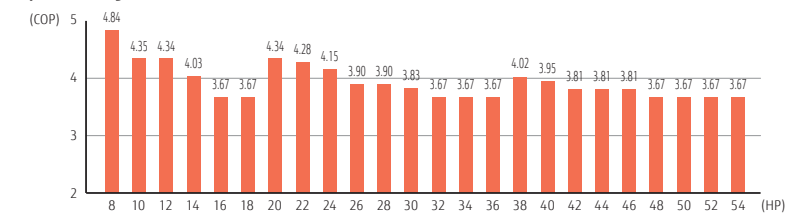

Energy efficiency combination

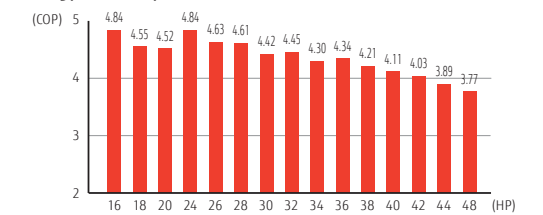

* These specifications are determined by Cassette combination.

Energy saving technology that boosted operation efficiency



- Powerful large propeller fan**
By using CFD* technology, a newly designed fan achieves high performance and low noise operation. *CFD: Computational Fluid Dynamics
- 3 phase DC fan motor**
Efficiency is substantially improved by high efficient motor with sophisticated driver control. In addition, low noise is realized by DC fan motor.
- Sine-wave DC inverter control**
High efficiency is realized by adoption of reduced switching loss IPM.
- 4-face heat exchanger**
Heat exchange efficiency is significantly improved by the introduction of a new 4-face heat exchanger that increases effective surface area.
- Subcool heat exchanger**
High Heat Exchange efficiency is achieved by using an internal projection shape double pipe construction.
- High efficient & Large capacity ALL DC inverter compressor**
Large capacity high efficient DC twin rotary compressor with 0.1Hz steps compressor speed control
- Front intake port (corner cut air inhaling structure)**

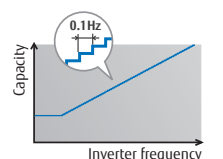

Outdoor units lineup

• Combinations other than the followings are not recommended.

Space saving combinations

22.4kW (8HP) AJH072LALBH UNIT : AJH072LALBH	28.0kW (10HP) AJH090LALBH UNIT : AJH090LALBH	33.5kW (12HP) AJH108LALBH UNIT : AJH108LALBH	40.0kW (14HP) AJH126LALBH UNIT : AJH126LALBH	45.0kW (16HP) AJH144LALBH UNIT : AJH144LALBH
50.0 kW (18HP) AJH162LALBH UNIT : AJH162LALBH	56.0kW (20HP) AJH180LALBH UNIT : AJH090/090LALBH	62.4 kW (22HP) AJH198LALBH UNIT : AJH126/072LALBH	68.0 kW (24HP) AJH216LALBH UNIT : AJH126/090LALBH	73.0 kW (26HP) AJH234LALBH UNIT : AJH144/090LALBH
78.0 kW (28HP) AJH252LALBH UNIT : AJH162/090LALBH	85.0 kW (30HP) AJH270LALBH UNIT : AJH144/126LALBH	90.0 kW (32HP) AJH288LALBH UNIT : AJH144/144LALBH	95.0 kW (34HP) AJH306LALBH UNIT : AJH162/144LALBH	100.0 kW (36HP) AJH324LALBH UNIT : AJH162/162LALBH
106.0 kW (38HP) AJH342LALBH UNIT : AJH162/090/090LALBH	113.0 kW (40HP) AJH360LALBH UNIT : AJH144/126/090LALBH	118.0 kW (42HP) AJH378LALBH UNIT : AJH144/144/090LALBH	123.0 kW (44HP) AJH396LALBH UNIT : AJH162/144/090LALBH	128.0 kW (46HP) AJH414LALBH UNIT : AJH162/162/090LALBH
135.0 kW (48HP) AJH432LALBH UNIT : AJH144/144/144LALBH	140.0 kW (50HP) AJH450LALBH UNIT : AJH162/144/144LALBH	145.0 kW (52HP) AJH468LALBH UNIT : AJH162/162/144LALBH	150.0 kW (54HP) AJH486LALBH UNIT : AJH162/162/162LALBH	

Energy efficiency combinations

44.8 kW (16HP) AJH144LALBHH UNIT : AJH072/072LALBH	50.4kW (18HP) AJH162LALBHH UNIT : AJH090/072LALBH	55.9 kW (20HP) AJH180LALBHH UNIT : AJH108/072LALBH	67.2 kW (24HP) AJH216LALBHH UNIT : AJH072/072/072LALBH	72.8 kW (26HP) AJH234LALBHH UNIT : AJH090/072/072LALBH
78.3 kW (28HP) AJH252LALBHH UNIT : AJH108/072/072LALBH	84.8 kW (30HP) AJH270LALBHH UNIT : AJH126/072/072LALBH	89.4 kW (32HP) AJH288LALBHH UNIT : AJH108/108/072LALBH	95.9 kW (34HP) AJH306LALBHH UNIT : AJH126/108/072LALBH	100.5 kW (36HP) AJH324LALBHH UNIT : AJH108/108/108LALBH
107.0 kW (38HP) AJH342LALBHH UNIT : AJH126/108/108LALBH	113.5 kW (40HP) AJH360LALBHH UNIT : AJH126/126/108LALBH	120.0 kW (42HP) AJH378LALBHH UNIT : AJH126/126/126LALBH	125.0 kW (44HP) AJH396LALBHH UNIT : AJH144/126/108LALBH	130.0 kW (46HP) AJH414LALBHH UNIT : AJH144/144/126LALBH

Dimensions

8,10HP : AJH072LALBH / AJH090LALBH

(Unit : mm)

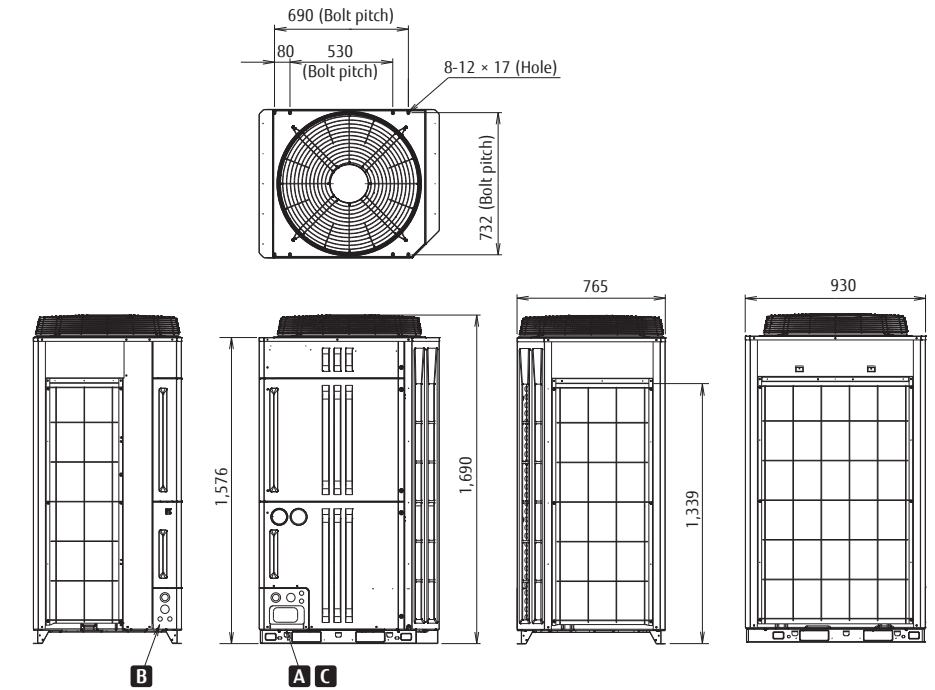

12,14,16,18HP : AJH108LALBH / AJH126LALBH / AJH144LALBH / AJH162LALBH

(Unit : mm)

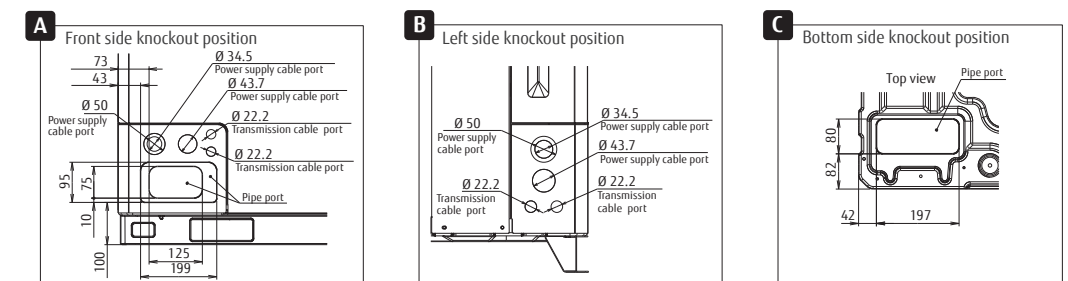
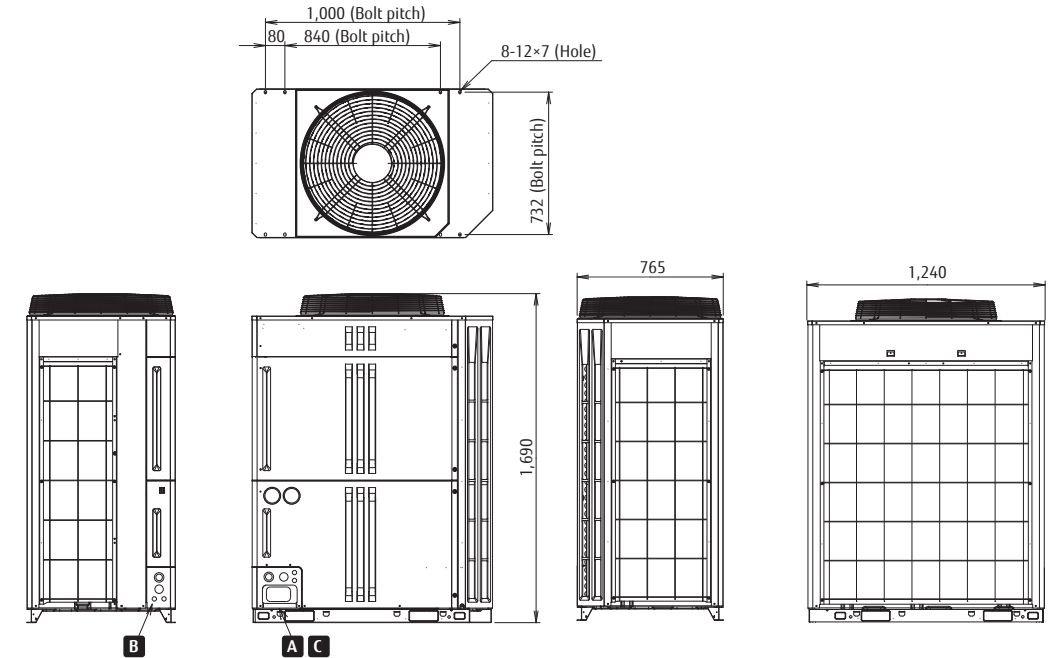

Space Saving Combinations

Rating Capacity range		HP	8	10	12	14	16	18	20	22	24	26	28	30	32	34	36	38	40	42	44	46	48	50	52	54
Model name			AJH072LALBH	AJH090LALBH	AJH108LALBH	AJH126LALBH	AJH144LALBH	AJH162LALBH	AJH180LALBH	AJH198LALBH	AJH216LALBH	AJH234LALBH	AJH252LALBH	AJH270LALBH	AJH288LALBH	AJH306LALBH	AJH324LALBH	AJH342LALBH	AJH360LALBH	AJH378LALBH	AJH396LALBH	AJH414LALBH	AJH432LALBH	AJH450LALBH	AJH468LALBH	AJH486LALBH
Unit 1			AJH072LALBH	AJH090LALBH	AJH108LALBH	AJH126LALBH	AJH144LALBH	AJH162LALBH	AJH180LALBH	AJH198LALBH	AJH216LALBH	AJH234LALBH	AJH252LALBH	AJH270LALBH	AJH288LALBH	AJH306LALBH	AJH324LALBH	AJH342LALBH	AJH360LALBH	AJH378LALBH	AJH396LALBH	AJH414LALBH	AJH432LALBH	AJH450LALBH	AJH468LALBH	AJH486LALBH
Unit 2			AJH072LALBH	AJH090LALBH	AJH108LALBH	AJH126LALBH	AJH144LALBH	AJH162LALBH	AJH180LALBH	AJH198LALBH	AJH216LALBH	AJH234LALBH	AJH252LALBH	AJH270LALBH	AJH288LALBH	AJH306LALBH	AJH324LALBH	AJH342LALBH	AJH360LALBH	AJH378LALBH	AJH396LALBH	AJH414LALBH	AJH432LALBH	AJH450LALBH	AJH468LALBH	AJH486LALBH
Unit 3			AJH072LALBH	AJH090LALBH	AJH108LALBH	AJH126LALBH	AJH144LALBH	AJH162LALBH	AJH180LALBH	AJH198LALBH	AJH216LALBH	AJH234LALBH	AJH252LALBH	AJH270LALBH	AJH288LALBH	AJH306LALBH	AJH324LALBH	AJH342LALBH	AJH360LALBH	AJH378LALBH	AJH396LALBH	AJH414LALBH	AJH432LALBH	AJH450LALBH	AJH468LALBH	AJH486LALBH
Maximum Connectable Indoor Unit*1			17	21	26	30	34	39	43	47	52	56	60	64	64	64	64	64	64	64	64	64	64	64	64	64
Indoor unit connectable capacity		Cooling	11.2-33.6	14.0-42.0	16.8-50.2	20.0-60.0	22.5-67.5	25.0-67.5	28.0-84.0	31.2-93.6	34.0-102.0	36.5-109.5	39.0-109.5	42.5-127.5	45.0-135.0	47.5-135.0	50.0-135.0	53.0-151.5	56.5-169.5	59.0-177.0	61.5-177.0	64.0-177.0	67.5-202.5	70.0-202.5	72.5-202.5	75.0-202.5
Power source			3 phase 4 wire, 400 V, 50Hz												3 phase 4 wire, 400 V, 50Hz											
Capacity		Cooling	22.4	28.0	33.5	40.0	45.0	50.0	56.0	62.4	68.0	73.0	78.0	85.0	90.0	95.0	100.0	106.0	113.0	118.0	123.0	128.0	135.0	140.0	145.0	150.0
		Heating	25.0	31.5	37.5	45.0	50.0	50.0	63.0	70.0	76.5	81.5	81.5	95.0	100.0	100.0	100.0	100.0	113.0	126.5	131.5	131.5	150.0	150.0	150.0	150.0
Input power		Cooling	5.20	7.28	8.96	10.96	13.01	16.56	14.56	16.16	18.24	20.29	23.84	23.97	26.02	29.57	33.12	31.12	31.25	33.30	36.85	40.40	39.03	42.58	46.13	49.68
		Heating	5.17	7.25	8.65	11.17	13.63	13.63	14.50	16.34	18.42	20.88	20.88	24.80	27.26	27.26	27.26	28.13	32.05	34.51	34.51	34.51	40.89	40.89	40.89	40.89
EER		Cooling	4.31	3.85	3.74	3.65	3.46	3.02	3.85	3.86	3.73	3.60	3.27	3.55	3.46	3.21	3.02	3.41	3.62	3.54	3.34	3.17	3.46	3.29	3.14	3.02
COP		Heating	4.84	4.35	4.34	4.03	3.67	3.67	4.34	4.28	4.15	3.90	3.90	3.83	3.67	3.67	3.67	4.02	3.95	3.81	3.81	3.81	3.67	3.67	3.67	3.67
Air flow rate		High	11,100	11,100	13,000	13,000	13,700	13,700	11,100*2	13,000+11,100	13,000+11,100	13,700+11,100	13,700+11,100	13,700+13,000	13,700*2	13,700*2	13,700*2	13,700+11,100*2	13,700+13,000+11,100	13,700*2+11,100	13,700*2+11,100	13,700*2+11,100	13,700*3	13,700*3	13,700*3	13,700*3
Sound pressure level*2 / Power level		Cooling	56 / 77	58 / 79	57 / 78	60 / 81	62 / 83	63 / 84	61 / 82	61 / 82	62 / 83	63 / 84	64 / 85	64 / 85	65 / 88	66 / 87	66 / 87	65 / 86	65 / 86	66 / 87	66 / 87	67 / 87	67 / 88	67 / 88	67 / 88	68 / 89
		Heating	58 / 80	59 / 81	60 / 83	62 / 84	64 / 86	64 / 86	62 / 84	63 / 85	64 / 86	65 / 87	65 / 87	66 / 88	67 / 89	67 / 89	67 / 89	66 / 88	67 / 89	68 / 90	68 / 90	68 / 90	69 / 91	69 / 91	69 / 91	69 / 91
Maximum external static pressure			82	82	82	82	82	82	82	82	82	82	82	82	82	82	82	82	82	82	82	82	82	82	82	82
Compressor motor output			7.5	7.5	11.0	11.0	11.0	11.0	7.5*2	11.0*7.5	11.0*7.5	11.0*7.5	11.0*7.5	11.0*2	11.0*2	11.0*2	11.0*2	11.0*7.5*2	11.0*2+7.5	11.0*2+7.5	11.0*2+7.5	11.0*2+7.5	11.0*3	11.0*3	11.0*3	11.0*3
Heat exchanger fin			Blue fin	Blue fin	Blue fin	Blue fin	Blue fin	Blue fin	Blue fin	Blue fin	Blue fin	Blue fin	Blue fin	Blue fin	Blue fin	Blue fin	Blue fin	Blue fin	Blue fin	Blue fin	Blue fin	Blue fin	Blue fin	Blue fin	Blue fin	Blue fin
Dimensions		Height	1,690	1,690	1,690	1,690	1,690	1,690	1,690	1,690	1,690	1,690	1,690	1,690	1,690	1,690	1,690	1,690	1,690	1,690	1,690	1,690	1,690	1,690	1,690	1,690
		Width	930	930	1,240	1,240	1,240	1,240	930*2	1,240+930	1,240+930	1,240+930	1,240+930	1,240*2	1,240*2	1,240*2	1,240*2	1,240+930*2	1,240+930	1,240+930	1,240+930	1,240+930	1,240*3	1,240*3	1,240*3	1,240*3
		Depth	765	765	765	765	765	765	765	765	765	765	765	765	765	765	765	765	765	765	765	765	765	765	765	765
Weight			252	252	275	275	275	275	252*2	275+252	275+252	275+252	275+252	275*2	275*2	275*2	275*2	275+252*2	275+252	275+252	275+252	275+252	275*3	275*3	275*3	275*3
Refrigerant		Type (Global Warming Potential)	R410A (2,088)	R410A (2,088)	R410A (2,088)	R410A (2,088)	R410A (2,088)	R410A (2,088)	R410A (2,088)	R410A (2,088)	R410A (2,088)	R410A (2,088)	R410A (2,088)	R410A (2,088)	R410A (2,088)	R410A (2,088)	R410A (2,088)	R410A (2,088)	R410A (2,088)	R410A (2,088)	R410A (2,088)	R410A (2,088)	R410A (2,088)	R410A (2,088)	R410A (2,088)	
		Charge	11.7 (24.4)	11.7 (24.4)	11.8 (24.6)	11.8 (24.6)	11.8 (24.6)	11.8 (24.6)	11.7*2 (24.4*2)	11.8+11.7 (24.6+24.4)	11.8+11.7 (24.6+24.4)	11.8+11.7 (24.6+24.4)	11.8+11.7 (24.6+24.4)	11.8*2 (24.6*2)	11.8*2 (24.6*2)	11.8*2 (24.6*2)	11.8*2 (24.6*2)	11.8+11.7*2 (24.6+24.4*2)	11.8*2+11.7 (24.6*2+24.4)	11.8*2+11.7 (24.6*2+24.4)	11.8*2+11.7 (24.6*2+24.4)	11.8*2+11.7 (24.6*2+24.4)	11.8*3 (24.6*3)	11.8*3 (24.6*3)	11.8*3 (24.6*3)	11.8*3 (24.6*3)
Connection pipe diameter		Liquid	12.70	12.70	12.70	12.70	12.70	15.88	15.88	15.88	15.88	15.88	15.88	19.05	19.05	19.05	19.05	19.05	19.05	19.05	19.05	19.05	19.05	19.05	19.05	19.05
		Discharge Gas	22.22	22.22	28.58	28.58	28.58	28.58	28.58	34.92	34.92	34.92	34.92	34.92	34.92	34.92	41.27	41.27	41.27	41.27	41.27	41.27	41.27	41.27	41.27	41.27
Operating range		Cooling	-15 to 46	-15 to 46	-15 to 46	-15 to 46	-15 to 46	-15 to 46	-5 to 46	-5 to 46	-5 to 46	-5 to 46	-5 to 46	-5 to 46	-5 to 46	-5 to 46	-5 to 46	-5 to 46	-5 to 46	-5 to 46	-5 to 46	-5 to 46	-5 to 46	-5 to 46	-5 to 46	-5 to 46
		Heating	-20 to 21	-20 to 21	-20 to 21	-20 to 21	-20 to 21	-20 to 21	-20 to 21	-20 to 21	-20 to 21	-20 to 21	-20 to 21	-20 to 21	-20 to 21	-20 to 21	-20 to 21	-20 to 21	-20 to 21	-20 to 21	-20 to 21	-20 to 21	-20 to 21	-20 to 21	-20 to 21	-20 to 21

Energy Efficiency Combinations

Rating Capacity range		HP	16	18	20	24	26	28	30	32	34	36	38	40	42	44	46	
Model name			AJH144LALBHH	AJH162LALBHH	AJH180LALBHH	AJH216LALBHH	AJH234LALBHH	AJH252LALBHH	AJH270LALBHH	AJH288LALBHH	AJH306LALBHH	AJH324LALBHH	AJH342LALBHH	AJH360LALBHH	AJH378LALBHH	AJH396LALBHH	AJH414LALBHH	
Unit 1			AJH072LALBH	AJH090LALBH	AJH108LALBH	AJH072LALBH	AJH090LALBH	AJH108LALBH	AJH126LALBH	AJH108LALBH	AJH126LALBH	AJH108LALBH	AJH126LALBH	AJH126LALBH	AJH126LALBH	AJH144LALBH	AJH144LALBH	
Unit 2			AJH072LALBH	AJH090LALBH	AJH108LALBH	AJH072LALBH	AJH090LALBH	AJH108LALBH	AJH126LALBH	AJH108LALBH	AJH126LALBH	AJH108LALBH	AJH126LALBH	AJH126LALBH	AJH126LALBH	AJH144LALBH	AJH144LALBH	
Unit 3			AJH072LALBH	AJH090LALBH	AJH108LALBH	AJH072LALBH	AJH090LALBH	AJH108LALBH	AJH126LALBH	AJH108LALBH	AJH126LALBH	AJH108LALBH	AJH126LALBH	AJH126LALBH	AJH126LALBH	AJH144LALBH	AJH144LALBH	
Maximum Connectable Indoor Unit*1			34	39	43	52	56	60	64	64	64	64	64	64	64	64		
Indoor unit connectable capacity		Cooling	22.4-67.2	25.2-75.6	28.0-83.8	33.6-100.8	36.4-109.2	39.2-117.4	42.4-127.2	44.7-134.1	48.0-143.8	50.3-150.7	53.5-160.5	56.8-170.2	60.0-180.0	62.5-187.5	65.0-195.0	
Power source			3 phase 4 wire, 400 V, 50Hz												3 phase 4 wire, 400 V, 50Hz			
Capacity		Cooling	44.8	50.4	55.9	67.2	72.8	78.3	84.8	89.4	95.9	100.5	107.0	113.5	120.0	125.0	130.0	
		Heating	50.0	56.5	62.5	75.0	81.5	87.5	95.0	100.0	107.5	112.5	120.0	127.5	135.0	140.0	145.0	
Input power		Cooling	10.40	12.48	14.16	15.60	17.68	19.36	21.36	23.12	25.12	26.88	28.88	30.88	32.88	34.93	36.98	
		Heating	10.34	12.42	13.82	15.51	17.59	18.99	21.51	22.47	24.99	25.95	28.47	30.99	33.51	35.97	38.43	
EER		Cooling	4.31	4.04	3.95	4.31	4.12	4.04	3.97	3.87	3.82	3.74	3.70	3.68	3.65	3.58	3.52	
COP		Heating	4.84	4.55	4.52	4.84	4.63	4.61	4.42	4.45	4.30	4.34	4.21	4.11	4.03	3.89	3.77	
Air flow rate		High	11,100*2	11,100*2	13,000+11,100	11,100*3	11,000*3	13,000+11,100*2	13,000+11,100*2	13,000*2+11,100	13,000*2+11,100	13,000*3	13,000*3	13,000*3	13,000*3	13,700+13,000*2	13,700*2+13,000	
Sound pressure level*2 / Power level		Cooling	59 / 80	60 / 81	60 / 81	61 / 82	62 / 83											

HEAT PUMP TYPE

VRF V-III Tropical Series



Fujitsu General tropical VRF is designed for tropical weather. Extensive lineup from 8HP to 54HP in 2HP increment. Connectable indoor unit capacity ratio up to 130%

System Outline

High ambient operation design

Possible to operate cooling up to 52°C outdoor temperature

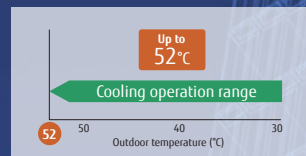

Powerful cooling capacity design

Keeping high cooling power at even high ambient temperature

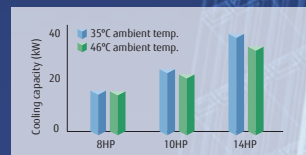

Anti-corrosion treatment design

All metallic and PCB components are protected against corrosion



Large Office

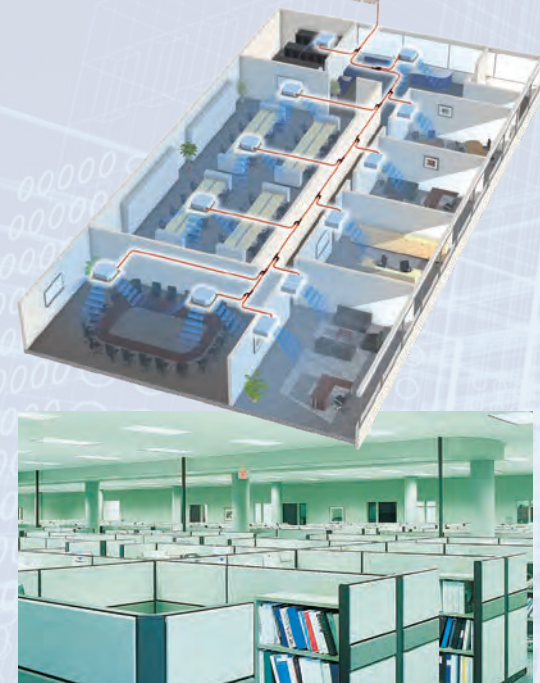

System configuration example

- This system is used for medium-sized and large buildings. Connecting each outdoor unit makes it possible to create a high-capacity system.
- Connection of multiple indoor units using separation tubes and headers.

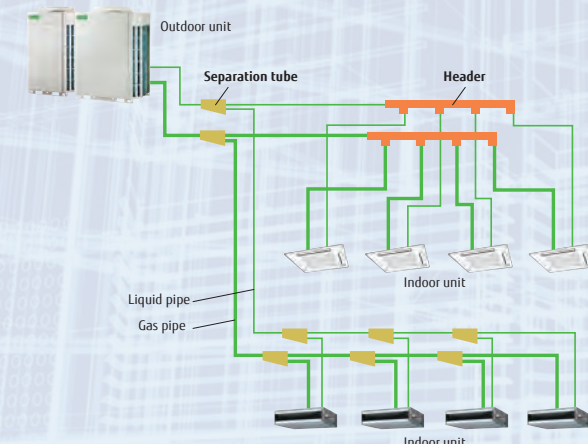

Features

Efficiency in actual operation

Top class high COP is realized for all combinations by our unique heat exchanger structure, high efficient DC twin compressor, and other our own technologies.

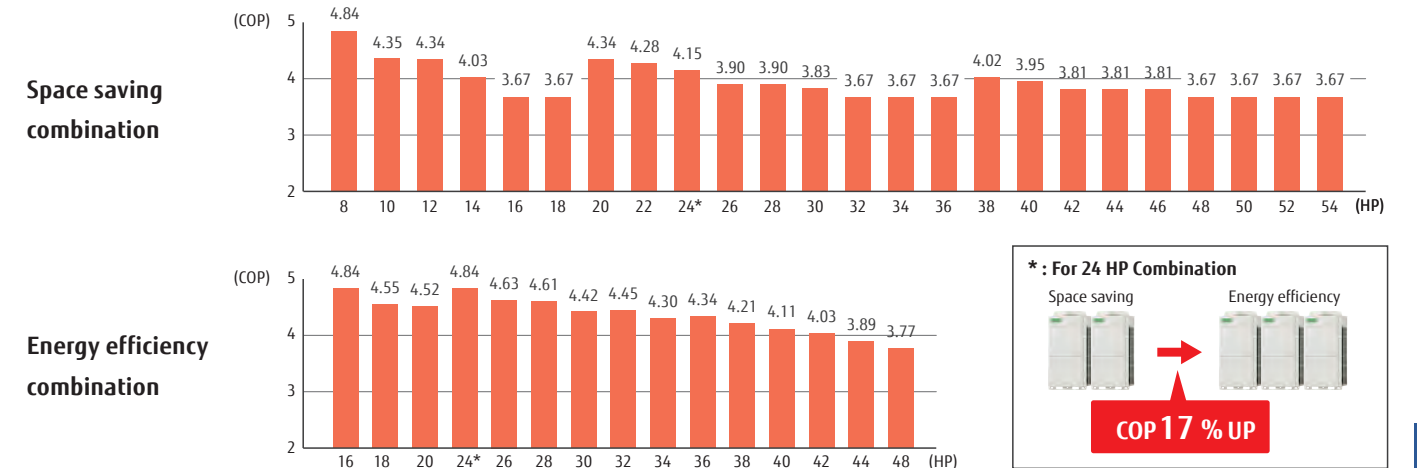

Energy saving technology that boosted operation efficiency

- Powerful large propeller fan**
By using CFD*1 technology, a newly designed fan achieves high performance and low noise operation. *1. CFD = Computational Fluid Dynamics
- 3 phase DC fan motor**
Efficiency is substantially improved by high efficient motor with sophisticated driver control. In addition, low noise is realized by DC fan motor.
- Subcool heat exchanger**
High Heat Exchange efficiency is achieved by using an internal projection shape double pipe construction.
- Sine-wave DC inverter control**
High efficiency is realized by adoption of reduced switching loss IPM.
- High efficient & Large capacity DC inverter compressor**
Large capacity high efficient DC twin rotary compressor with 0.1Hz steps compressor speed control
- 4-face heat exchanger**
Heat exchange efficiency is significantly improved by the introduction of a new 4-face heat exchanger that increases effective surface area.
- Front intake port** (corner cut air inhaling structure)

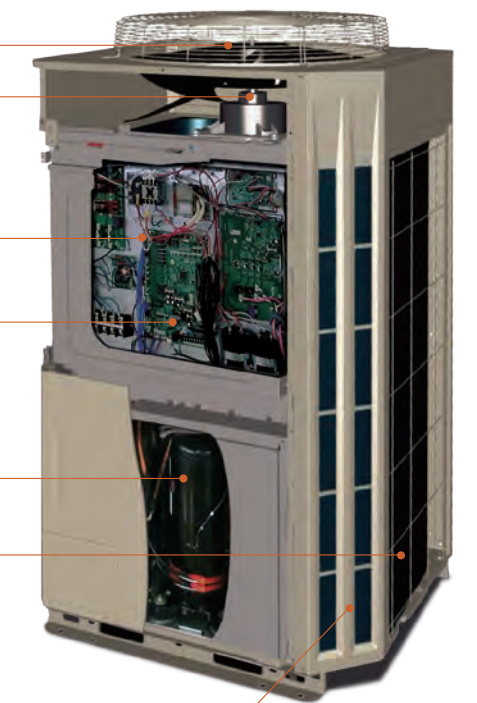
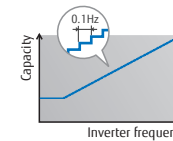

Advanced energy saving control

Multiple outdoor operation control

This control method operates all compressors at part load and distributes refrigerant to all heat exchangers to improve the overall system efficiency.

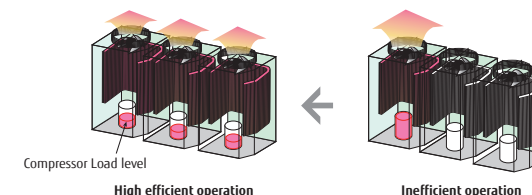

Heat exchanger refrigerant control

The efficiency of the top and bottom heat exchanger in the outdoor unit has been improved by adopting an optimum refrigerant path control.

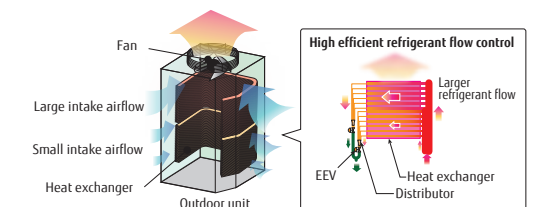

Outdoor units lineup

• Combinations other than the followings are not recommended.

Space saving combinations

22.4kW (8HP) AJH072LNTCH UNIT : AJH072LNTCH	28.0kW (10HP) AJH090LNTCH UNIT : AJH090LNTCH	33.5kW (12HP) AJH108LNTCH UNIT : AJH108LNTCH	40.0kW (14HP) AJH126LNTCH UNIT : AJH126LNTCH	45.0kW (16HP) AJH144LNTCH UNIT : AJH144LNTCH
50.0 kW (18HP) AJH162LNTCH UNIT : AJH162LNTCH	56.0kW (20HP) AJH180LNTCH UNIT : AJH090/090LNTCH	62.4 kW (22HP) AJH198LNTCH UNIT : AJH126/072LNTCH	68.0 kW (24HP) AJH216LNTCH UNIT : AJH126/090LNTCH	73.0 kW (26HP) AJH234LNTCH UNIT : AJH144/090LNTCH
78.0 kW (28HP) AJH252LNTCH UNIT : AJH162/090LNTCH	85.0 kW (30HP) AJH270LNTCH UNIT : AJH144/126LNTCH	90.0 kW (32HP) AJH288LNTCH UNIT : AJH144/144LNTCH	95.0 kW (34HP) AJH306LNTCH UNIT : AJH162/144LNTCH	100.0 kW (36HP) AJH324LNTCH UNIT : AJH162/162LNTCH
106.0 kW (38HP) AJH342LNTCH UNIT : AJH162/090/090LNTCH	113.0 kW (40HP) AJH360LNTCH UNIT : AJH144/126/090LNTCH	118.0 kW (42HP) AJH378LNTCH UNIT : AJH144/144/090LNTCH	123.0 kW (44HP) AJH396LNTCH UNIT : AJH162/144/090LNTCH	128.0 kW (46HP) AJH414LNTCH UNIT : AJH162/162/090LNTCH
135.0 kW (48HP) AJH432LNTCH UNIT : AJH144/144/144LNTCH	140.0 kW (50HP) AJH450LNTCH UNIT : AJH162/144/144LNTCH	145.0 kW (52HP) AJH468LNTCH UNIT : AJH162/162/144LNTCH	150.0 kW (54HP) AJH486LNTCH UNIT : AJH162/162/162LNTCH	

Energy efficiency combinations

44.8 kW (16HP) AJH144LNTCHH UNIT : AJH072/072LNTCH	50.4kW (18HP) AJH162LNTCHH UNIT : AJH090/072LNTCH	55.9 kW (20HP) AJH180LNTCHH UNIT : AJH108/072LNTCH	67.2 kW (24HP) AJH216LNTCHH UNIT : AJH072/072/072LNTCH	72.8 kW (26HP) AJH234LNTCHH UNIT : AJH090/072/072LNTCH
78.3 kW (28HP) AJH252LNTCHH UNIT : AJH108/072/072LNTCH	84.8 kW (30HP) AJH270LNTCHH UNIT : AJH126/072/072LNTCH	89.4 kW (32HP) AJH288LNTCHH UNIT : AJH108/108/072LNTCH	95.9 kW (34HP) AJH306LNTCHH UNIT : AJH126/108/072LNTCH	100.5 kW (36HP) AJH324LNTCHH UNIT : AJH108/108/108LNTCH
107.0 kW (38HP) AJH342LNTCHH UNIT : AJH126/108/108LNTCH	113.5 kW (40HP) AJH360LNTCHH UNIT : AJH126/126/108LNTCH	120.0 kW (42HP) AJH378LNTCHH UNIT : AJH126/126/126LNTCH	125.0 kW (44HP) AJH396LNTCHH UNIT : AJH144/126/126LNTCH	130.0 kW (46HP) AJH414LNTCHH UNIT : AJH144/144/126LNTCH

Dimensions

8,10HP : AJH072LNTCH / AJH090LNTCH

(Unit : mm)

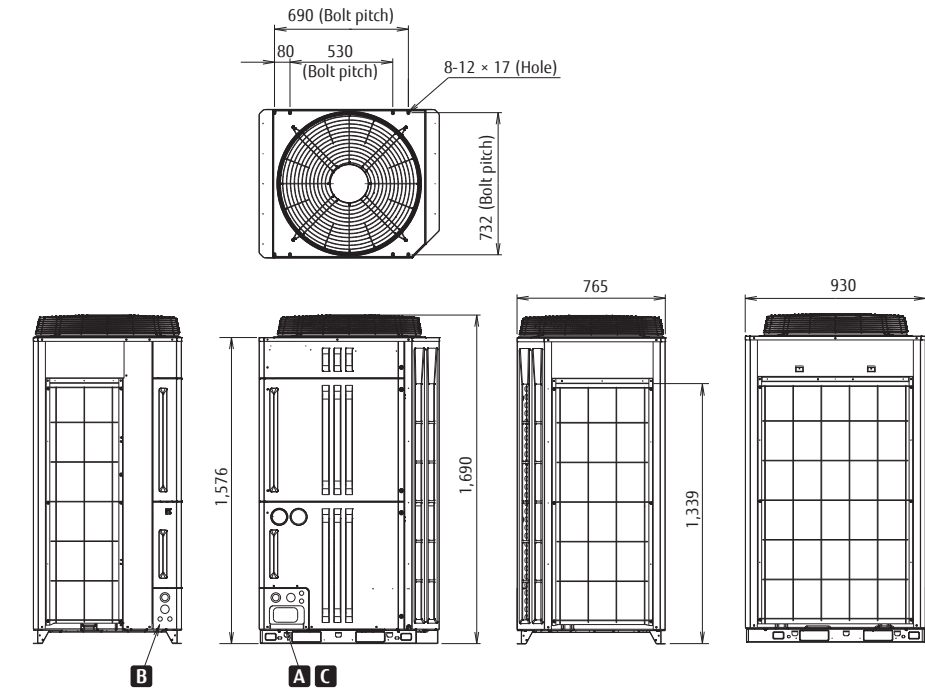

12,14,16,18HP : AJH108LNTCH / AJH126LNTCH / AJH144LNTCH / AJH162LNTCH

(Unit : mm)

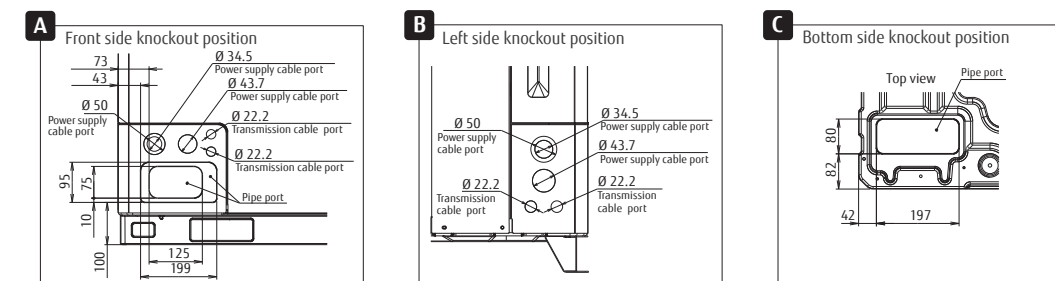
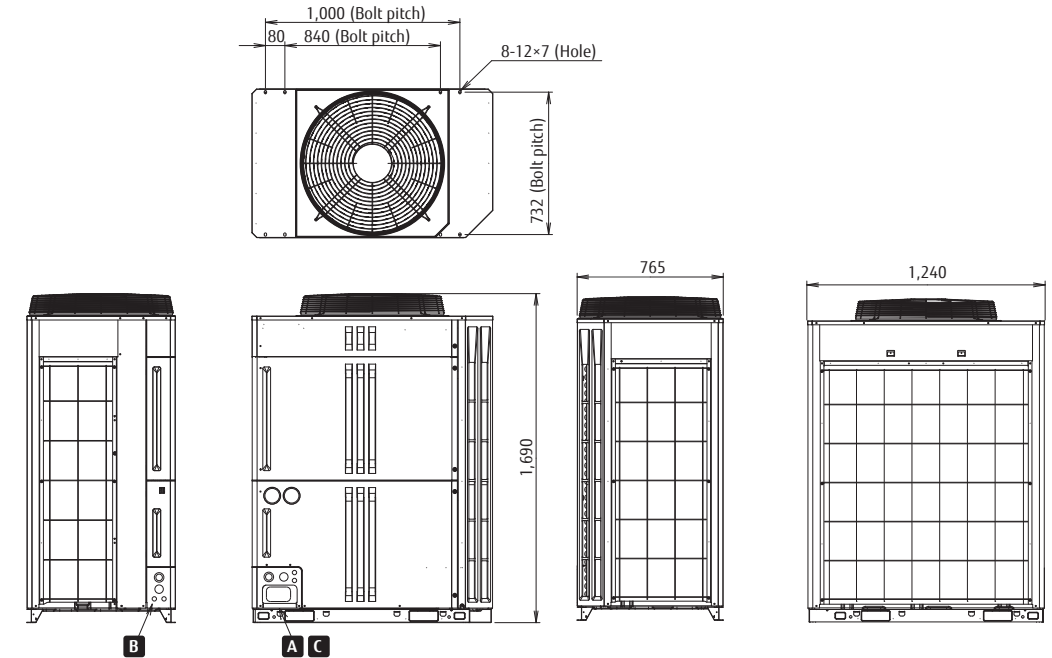

Space Saving Combinations

Rating Capacity range		HP	8	10	12	14	16	18	20	22	24	26	28	30	32	34	36	38	40	42	44	46	48	50	52	54	
Model name			AJH072LNTCH	AJH090LNTCH	AJH108LNTCH	AJH126LNTCH	AJH144LNTCH	AJH162LNTCH	AJH180LNTCH	AJH198LNTCH	AJH216LNTCH	AJH234LNTCH	AJH252LNTCH	AJH270LNTCH	AJH288LNTCH	AJH306LNTCH	AJH324LNTCH	AJH342LNTCH	AJH360LNTCH	AJH378LNTCH	AJH396LNTCH	AJH414LNTCH	AJH432LNTCH	AJH450LNTCH	AJH468LNTCH	AJH486LNTCH	
Unit 1			AJH072LNTCH	AJH090LNTCH	AJH108LNTCH	AJH126LNTCH	AJH144LNTCH	AJH162LNTCH	AJH180LNTCH	AJH198LNTCH	AJH216LNTCH	AJH234LNTCH	AJH252LNTCH	AJH270LNTCH	AJH288LNTCH	AJH306LNTCH	AJH324LNTCH	AJH342LNTCH	AJH360LNTCH	AJH378LNTCH	AJH396LNTCH	AJH414LNTCH	AJH432LNTCH	AJH450LNTCH	AJH468LNTCH	AJH486LNTCH	
Unit 2			AJH072LNTCH	AJH090LNTCH	AJH108LNTCH	AJH126LNTCH	AJH144LNTCH	AJH162LNTCH	AJH180LNTCH	AJH198LNTCH	AJH216LNTCH	AJH234LNTCH	AJH252LNTCH	AJH270LNTCH	AJH288LNTCH	AJH306LNTCH	AJH324LNTCH	AJH342LNTCH	AJH360LNTCH	AJH378LNTCH	AJH396LNTCH	AJH414LNTCH	AJH432LNTCH	AJH450LNTCH	AJH468LNTCH	AJH486LNTCH	
Unit 3			AJH072LNTCH	AJH090LNTCH	AJH108LNTCH	AJH126LNTCH	AJH144LNTCH	AJH162LNTCH	AJH180LNTCH	AJH198LNTCH	AJH216LNTCH	AJH234LNTCH	AJH252LNTCH	AJH270LNTCH	AJH288LNTCH	AJH306LNTCH	AJH324LNTCH	AJH342LNTCH	AJH360LNTCH	AJH378LNTCH	AJH396LNTCH	AJH414LNTCH	AJH432LNTCH	AJH450LNTCH	AJH468LNTCH	AJH486LNTCH	
Maximum Connectable Indoor Unit			13	16	19	23	26	29	33	36	40	43	46	50	53	55	55	55	55	55	55	55	55	55	55	55	
Indoor unit connectable capacity		Cooling	11.2-29.1	14.0-36.4	16.8-43.5	20.0-52.0	22.5-58.5	25.0-65.0	28.0-72.8	31.2-81.1	34.0-88.4	36.5-94.9	39.0-101.4	42.5-110.5	45.0-117.0	47.5-123.5	50.0-130.0	53.0-137.8	56.5-146.9	59.0-153.4	61.5-159.9	64.0-166.4	67.5-175.5	70.0-182	72.5-188.5	75.0-195.0	
Power source			3 phase 4 wire, 400 V, 50Hz												3 phase 4 wire, 400 V, 50Hz												
T1 condition	Capacity	Cooling	kW	22.4	28.0	33.5	40.0	45.0	50.0	56.0	62.4	68.0	73.0	78.0	85.0	90.0	95.0	100.0	106.0	113.0	118.0	123.0	128.0	135.0	140.0	145.0	150.0
		Heating	kW	25.0	31.5	37.5	45.0	50.0	50.0	63.0	70.0	76.5	81.5	81.5	81.5	95.0	100.0	100.0	100.0	113.0	126.5	131.5	131.5	131.5	150.0	150.0	150.0
	Input power	Cooling	Btu/h	76,400	95,500	114,300	136,500	153,500	170,600	191,000	212,900	232,000	249,000	266,100	290,000	307,000	324,100	341,200	361,600	385,500	402,500	419,600	436,700	460,500	477,600	494,700	511,800
		Heating	Btu/h	85,300	107,500	128,000	153,500	170,600	170,600	215,000	238,800	261,000	278,100	278,100	324,100	341,200	341,200	341,200	361,600	431,600	448,700	448,700	448,700	448,700	511,800	511,800	511,800
	Current	Cooling	A	9.2	12.0	15.0	17.7	20.7	26.1	-	-	-	-	-	-	-	-	-	-	-	-	-	-	-	-	-	-
		Heating	A	9.2	12.2	14.6	18.2	21.5	21.5	-	-	-	-	-	-	-	-	-	-	-	-	-	-	-	-	-	-
	EER	Cooling	W/W	4.31	3.85	3.74	3.65	3.46	3.02	3.85	3.86	3.73	3.60	3.27	3.55	3.46	3.21	3.02	3.41	3.62	3.54	3.34	3.17	3.46	3.29	3.14	3.02
		Heating	W/W	4.84	4.35	4.34	4.03	3.67	3.67	4.34	4.28	4.15	3.90	3.90	3.83	3.67	3.67	3.67	3.67	4.02	3.95	3.81	3.81	3.81	3.67	3.67	3.67
	COP	Cooling	Btu/h/W	14.7	13.1	12.8	12.5	11.8	10.3	13.1	13.2	12.7	12.3	11.2	12.1	11.8	11.0	11.6	12.3	12.1	11.4	10.8	11.8	11.7	11.2	10.7	10.3
		Heating	Btu/h/W	16.5	14.8	14.8	13.7	12.5	12.5	14.8	14.6	14.2	13.3	13.3	13.1	12.5	12.5	12.5	13.7	13.5	13.0	13.0	13.0	12.5	12.5	12.5	12.5
T3 condition	Capacity	Cooling	kW	20.2	25.2	32.0	35.1	35.2	50.4	52.2	57.2	60.3	60.4	67.1	70.2	70.3	70.4	85.6	92.3	95.4	95.5	95.6	105.3	105.4	105.5	105.6	
		Heating	kW	28.2	35.2	42.0	45.1	45.2	60.4	62.2	67.2	70.3	70.4	77.1	80.2	80.3	80.4	95.6	102.3	105.4	105.5	105.6	115.3	115.4	115.5	115.6	
	Input power	Cooling	Btu/h	68,900	86,000	97,200	109,200	119,800	120,100	172,000	178,100	195,200	205,800	206,100	229,000	239,600	239,900	240,200	292,100	315,000	325,600	325,900	326,200	359,400	359,700	360,000	360,300
		Heating	Btu/h	68,900	86,000	97,200	109,200	119,800	120,100	172,000	178,100	195,200	205,800	206,100	229,000	239,600	239,900	240,200	292,100	315,000	325,600	325,900	326,200	359,400	359,700	360,000	360,300
EER	Cooling	W/W	3.00	2.74	3.05	2.99	2.97	2.85	2.74	2.99	2.87	2.87	2.80	2.98	2.97	2.91	2.85	2.78	2.91	2.91	2.86	2.82	2.97	2.93	2.89	2.85	
	Heating	W/W	3.00	2.74	3.05	2.99	2.97	2.85	2.74	2.99	2.87	2.87	2.80	2.98	2.97	2.91	2.85	2.78	2.91	2.91	2.86	2.82	2.97	2.93	2.89	2.85	
Power factor		%	90	92	92	92	92	92	92	92	92	92	92	92	92	92	92	92	92	92	92	92	92	92	92	92	
Air flow rate	High	m³/h	11,100	11,100	13,000	13,000	13,700	13,700	11,100*2	13,000+11,100	13,000+11,100	13,700+11,100	13,700+11,100	13,700+13,000	13,700+2	13,700+2	13,700+2	13,700+2	13,700+11,100*2	13,700+13,000+11,100	13,700+2+11,100	13,700+2+11,100	13,700+3	13,700+3	13,700+3	13,700+3	
Sound pressure level*2 / Power level	Cooling	dB (A)	56 / 77	58 / 79	57 / 78	60 / 81	62 / 83	63 / 84	61 / 82	61 / 82	62 / 83	63 / 84	64 / 85	64 / 85	64 / 85	65 / 86	66 / 87	66 / 87	66 / 87	66 / 87	66 / 87	66 / 87	67 / 88	67 / 88	67 / 88	68 / 89	
	Heating	dB (A)	58 / 80	59 / 81	60 / 83	62 / 84	64 / 86	64 / 86	62 / 84	63 / 85	64 / 86	65 / 87	66 / 87	66 / 87	67 / 88	67 / 89	67 / 89	67 / 89	67 / 89	67 / 89	67 / 89	67 / 89	68 / 90	68 / 90	69 / 91	69 / 91	
Maximum external static pressure		Pa	82	82	82	82	82	82	82	82	82	82	82	82	82	82	82	82	82	82	82	82	82	82	82	82	
Compressor motor output		kW	7.5	7.5	11.0	11.0	11.0	7.5*2	11.0*7.5	11.0*7.5	11.0*7.5	11.0*7.5	11.0*7.5	11.0*2	11.0*2	11.0*2	11.0*2	11.0*2	11.0*2+7.5	11.0*2+7.5	11.0*2+7.5	11.0*2+7.5	11.0*3	11.0*3	11.0*3	11.0*3	
Heat exchanger fin		Blue fin	Blue fin	Blue fin	Blue fin	Blue fin	Blue fin	Blue fin	Blue fin	Blue fin	Blue fin	Blue fin	Blue fin	Blue fin	Blue fin	Blue fin	Blue fin	Blue fin	Blue fin	Blue fin	Blue fin	Blue fin	Blue fin	Blue fin	Blue fin	Blue fin	
Dimensions	Height	mm	1,690	1,690	1,690	1,690	1,690	1,690	1,690	1,690	1,690	1,690	1,690	1,690	1,690	1,690	1,690	1,690	1,690	1,690	1,690	1,690	1,690	1,690	1,690	1,690	
	Width	mm	930	930	1,240	1,240	1,240	930*2	1,240+930	1,240+930	1,240+930	1,240+930	1,240+930	1,240+2	1,240+2	1,240+2	1,240+2	1,240+2	1,240+930*2	1,240+2+930	1,240+2+930	1,240+2+930	1,240+3	1,240+3	1,240+3	1,240+3	
	Depth	mm	765	765	765	765	765	765	765	765	765	765	765	765	765	765	765	765	765	765	765	765	765	765	765	765	
Weight		kg	255	255	279	279	279	255*2	279+255	279+255	279+255	279+255	279+2	279+2	279+2	279+2	279+2	279+255*2	279+255	279+255	279+255	279+255	279+3	279+3	279+3	279+3	
Refrigerant	Type (Global Warming Potential)		R410A (2,088)	R410A (2,088)	R410A (2,088)	R410A (2,088)	R410A (2,088)	R410A (2,088)	R410A (2,088)	R410A (2,088)	R410A (2,088)	R410A (2,088)	R410A (2,088)	R410A (2,088)	R410A (2,088)	R410A (2,088)	R410A (2,088)	R410A (2,088)	R410A (2,088)	R410A (2,088)	R410A (2,088)	R410A (2,088)	R410A (2,088)	R410A (2,088)	R410A (2,088)		
	Charge	kg(CO2eq-T)	11.7(24.4)	11.7(24.4)	11.8(24.6)	11.8(24.6)	11.8(24.6)	11.8(24.6)	11.7+2(24.4*2)	11.8+11.7(24.6+24.4)	11.8+11.7(24.6+24.4)	11.8+11.7(24.6+24.4)	11.8+11.7(24.6+24.4)	11.8+2(24.6*2)	11.8+2(24.6*2)	11.8+2(24.6*2)	11.8+2(24.6*2)	11.8+2(24.6*2)	11.8+2+11.7(24.6+24.4)	11.8+2+11.7(24.6+24.4)	11.8+2+11.7(24.6+24.4)	11.8+2+11.7(24.6+24.4)	11.8+3(24.6*3)	11.8+3(24.6*3)	11.8+3(24.6*3)	11.8+3(24.6*3)	
Connection pipe diameter	Liquid	mm	12.70	12.70	12.70	12.70	12.70	15.88	15.88	15.88	15.88	15.88	19.05	19.05	19.05	19.05	19.05	19.05	19.05	19.05	19.05	19.05	19.05	19.05	19.05	19.05	
	Discharge Gas	mm	22.22	22.22	28.58	28.58	28.58	28.58	28.58	34.92	34.92	34.92	34.92	34.92	34.92	34.92	34.92	34.92	41.27	41.27	41.27	41.27	41.27	41.27	41.27	41.27	
Operating range	Cooling	°C	-15 to 52	-15 to 52	-15 to 52	-15 to 52	-15 to 52	-15 to 52	-15 to 52	-15 to 52	-15 to 52	-15 to 52	-15 to 52	-15 to 52	-15 to 52	-15 to 52	-15 to 52	-15 to 52	-15 to 52	-15 to 52	-15 to 52	-15 to 52	-15 to 52	-15 to 52	-15 to 52		
	Heating	°C	-20 to 21	-20 to 21	-20 to 21	-20 to 21	-20 to 21	-20 to 21	-20 to 21	-20 to 21	-20 to 21	-20 to 21	-20 to 21	-20 to 21	-20 to 21	-20 to 21	-20 to 21	-20 to 21	-20 to 21	-20 to 21	-20 to 21	-20 to 21	-20 to 21	-20 to 21	-20 to 21	-20 to 21	

Energy Efficiency Combinations

Rating Capacity range		HP	16	18	20	24	26	28	30	32	34	36	38	40	42	44	46
Model name			AJH144LNTCHH	AJH162LNTCHH	AJH180LNTCHH	AJH216LNTCHH	AJH234LNTCHH	AJH252LNTCHH	AJH270LNTCHH	AJH288LNTCHH	AJH306LNTCHH	AJH324LNTCHH	AJH342LNTCHH	AJH360LNTCHH	AJH378LNTCHH	AJH396LNTCHH	AJH414LNTCHH
Unit 1			AJH072LNTCH	AJH090LNTCH	AJH108LNTCH	AJH126LNTCH	AJH144LNTCH	AJH162LNTCH	AJH180LNTCH	AJH198LNTCH	AJH216LNTCH	AJH234LNTCH	AJH252LNTCH	AJH270LNTCH	AJH288LNTCH	AJH306LNTCH	AJH324LNTCH
Unit 2			AJH072LNTCH	AJH090LNTCH													



VRF INDOOR UNITS

16 Types and 148 models available to meet the requirements of any building design.

The VRF indoor units were developed to be highly efficient, compact, low noise and to have user friendly operation. With a variety of indoor units and capacities available, Fujitsu General has an indoor unit to match any requirement which is easy to install and maintain.

Further, a variety of options are available to achieve an air conditioning environment that is more desirable from the user's perspective.

INDOOR UNITS LINE-UP

Cassette (1-way Flow type)

3D Flow Cassette

4-way Flow Compact Cassette (Grid type / Standard type)

4-way Flow Cassette

Circular Flow Cassette

Mini Duct

Low Static Pressure Duct

Slim Duct / Slim Concealed Floor

Low / Medium Static Pressure Duct

High Static Pressure Duct

Floor (compact)

Floor / Ceiling

Ceiling

Wall Mounted



INDOOR UNITS LINE-UP

Comprehensive range of indoor units of variety design and capacity ranges available which can be selected to suit any air conditioning needs.
16 types, 179 models, Capacity range from 2.2kW to 28.0kW

*1:AUXA18/24GALH can not be connected to J-III Series.
*2:ARXC60/72/90/96 cannot be connected to J-IIS Series and J-III Series.
*: Circular Flow Cassette (except AUXM030GLAH) , Mini Duct, Low Static Pressure Duct, Slim Duct, Medium Static Pressure Duct, High Static Pressure Duct (ARXC45GATH only) can be connected to J-III Series for Singapore.

Indoor units range

Model code	7	9	12	14	18	24	30	34	36	45	54	60	72	90	96		
Capacity range (kW)	2.2	2.8	3.6	4.5	5.6	7.1	9.0	10.0	11.2	12.5	14.0	18.0	22.4	25.0	28.0		
Cassette	1-way Flow																
	3D Flow																
	4-way Flow Compact	(Grid type)		 AUXB09GATH	 AUXB12GATH	 AUXB14GATH	 AUXB18GATH	 AUXB24GATH									
		(Standard type)		 AUXB09GATH	 AUXB12GATH	 AUXB14GATH	 AUXB18GATH	 AUXB24GATH									
	4-way Flow	(Slim type)															
		(Large type)															
	Circular Flow	(Slim type)					 AUXM018GTAH	 AUXM024GTAH									
(Large type)								 AUXK030GTAH		 AUXK036GTAH	 AUXK045GTAH	 AUXK054GTAH					
Duct	Mini Duct (With drain pump)																
	Low Static Pressure Duct																
	Slim Duct (With drain pump)	 ARXD07GATH	 ARXD09GATH	 ARXD12GATH	 ARXD14GATH	 ARXD18GATH	 ARXD24GATH										
	Medium Static Pressure Duct						 ARXA24GBTH	 ARXA30GBTH			 ARXA36GBTH	 ARXA45GBTH					
	High Static Pressure Duct																
Floor	Concealed Floor (Same as Low Static Pressure Duct models)																
	Floor (Same as Ceiling models)																
	Slim Concealed Floor (Same as Slim Duct models)	 ARXD07GATH	 ARXD09GATH	 ARXD12GATH	 ARXD14GATH	 ARXD18GATH	 ARXD24GATH										
	Floor (compact)																
Ceiling	Ceiling																
Wall Mounted	Wall Mounted						 ASHA24GATH	 ASHA30GATH									

INDOOR UNITS

Cassette (1-way Flow type)

Models (Slim type)
 AUXV007GLEH / AUXV009GLEH / AUXV012GLEH
 AUXV014GLEH / AUXV018GLEH / AUXV024GLEH



AUXV007 AUXV009 AUXV012

AUXV014 AUXV018 AUXV024



Features

Compact chassis size

Their compact sizes make it easy to install them in a variety of commercial locations and environments.

- The chassis is less than 200 mm high in every model.
- All 4 to 12kBtu models are less than 1,000 mm wide.
- The chassis depth is 570 mm, which fits nicely into a grid-type ceiling.

Dimensions (Panel size)						(Unit : mm)
	7	9	12	14	18	24
H		198 (43)			198 (43)	
W		785 (950)			1,190 (1,360)	
D		570 (620)			570 (620)	

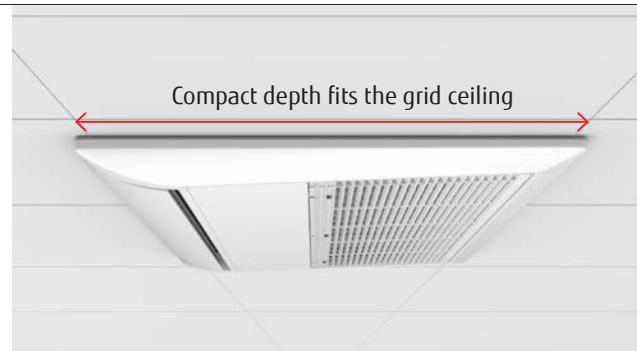

Wide airflow range

The large flap with triangularly arrayed louvers has a wider movable range and directs an airflow to the furthest corners of the room.



In cooling mode, the horizontal airflow reaches the furthest corners of the room and avoids hitting human bodies directly in order to provide comfortable air conditioning.

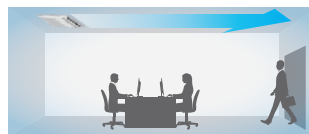

In heating mode, the warm air is directed downward toward the floor to warm the occupants' feet and lower bodies while keeping their heads relatively cool.

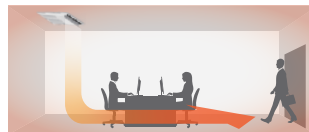

Note: This is a conceptual drawing. Air conditioning performance may vary depending on installation, room size, and the distance from the wall.

Low noise operation

They produce little noise during operation, which makes them an ideal choice for use in hotel rooms.

Flexible Installation

By using new L-type piping kit, more flexible installation is possible. Built-in drain pump as standard accessory, which enable to have maximum 700m piping height difference from the ceiling.

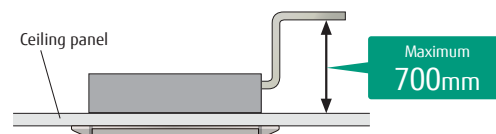

Optional parts

- IR Receiver Unit: UTY-TRHX
 Cassette Grille: UTG-UNGA-W (007/009/012)
 External Power Supply Unit: UTZ-GXXC



Specifications

Model name			AUXV007GLEH	AUXV009GLEH	AUXV012GLEH	AUXV014GLEH	AUXV018GLEH	AUXV024GLEH
Power source			Single phase - phase, ~230V, 50Hz					
Capacity	Cooling	kW	2.2	2.8	3.6	4.5	5.6	7.1
	Heating	kW	2.8	3.2	4.0	5.0	6.3	8.0
Input power	W		42/42	42/42	60/60	38/38	56/56	99/99
Airflow rate	m ³ /h (l/s)	High	550	550	670	720	890	1,150
		Med-High	440	440	520	660	840	1,020
		Med	420	420	480	630	770	940
		Med-Low	400	400	450	600	710	790
		Low	380	380	410	580	660	700
		Quiet	360	360	360	550	580	610
Sound pressure level	dB (A)	High	42	42	45	37	44	49
		Med-High	37	37	41	36	43	47
		Med	36	36	39	35	40	45
		Med-Low	35	35	38	34	38	42
		Low	33	33	36	33	36	39
		Quiet	32	32	32	32	34	36
Dimensions (H × W × D)	mm		198 × 785 × 570	198 × 785 × 570	198 × 785 × 570	198 × 1,190 × 570	198 × 1,190 × 570	198 × 1,190 × 570
Weight	kg		19 (42)	19 (42)	19 (42)	26 (57)	26 (57)	27 ()
Connection pipe diameter	Liquid (flare)	mm	6.35	6.35	6.35	6.35	6.35	9.52
	Gas (flare)	mm	9.52	9.52	12.70	12.70	12.70	15.88
Drain hose diameter (I.D./O.D.)			25 / 32					
Cassette grille	Model name		UTG-UNGA-W			UTG-UNGB-W		
	Dimensions (H×W×D)		43 × 950 × 620			43 × 1,360 × 620		
	Weight		6.5 (14.5)			8.5 (18.0)		

Note : Specifications are based on the following conditions.
 Cooling : Indoor temperature of 27°CDB / 19°CWB, and outdoor temperature of 35°CDB / 24°CWB.
 Heating : Indoor temperature of 20°CDB / (15°CWB), and outdoor temperature of 7°CDB / 6°CWB.
 Pipe length : 7.5 m; Height difference between outdoor unit and indoor unit : 0 m. Voltage : 230 [V].

Dimensions (Unit: mm)

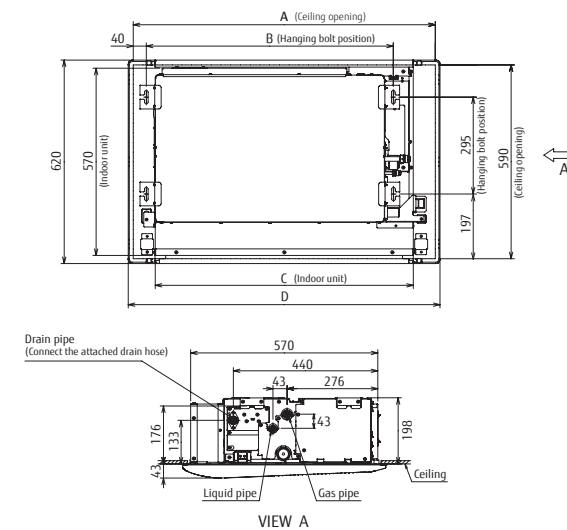

	AUXV007-012	AUXV014-024
A	920	1,330
B	752	1,152
C	785	1,190
D	950	1,360

3D Flow Cassette

Models

AUXS018GLEH / AUXS024GLEH



Feature

3 Air Outlet Ports can be controlled individually

Using the "Comfortable airflow setting" function allows the left and right air outlet ports and the wide center air outlet ports to automatically create a comfortable space for improved comfort.

Temperature distribution during cooling and heating (when set to comfortable airflow)

Cooling

When cooling operation is stable with an outside air temperature of 35°C, a set temperature of 18°C and an air volume set to "Hi" in a 40m² environmental our test room for the AUXS024GLEH

Heating

When heating operation is stable with an outside air temperature of 7°C, a set temperature of 30°C and an air volume set to "Hi" in a 40m² environmental our test room for the AUXS024GLEH

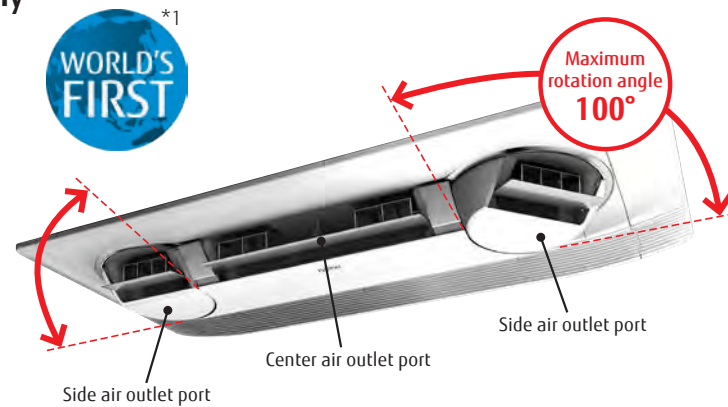

*1: Announced 2018. In room air conditioner for the home (our company's investigation)

Individual airflow setting

Equipped with an "Individual airflow setting" function that optimizes the airflow setting in accordance with the installation location.

Suitably setting the side air outlet ports to match how the space is used achieves air conditioning with no waste.

Optimum airflow control for improved comfort is achieved even for long rooms.

Individual air outlet port control

"Individual airflow setting" is possible using the Wired Remote Controller (Touch Panel) and Central Remote Controller*. The airflow of the respective air outlet ports can be individually set.

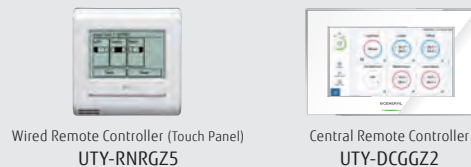

*Wired Remote Controller (Touch Panel) (UTY-RNRZ5) and Central remote controller (UTY-DCGYZ2) only

High Energy Saving

The "New structural design" featuring large intake and smooth output reduces air blowing loss to achieve top class energy saving.

Efficient air outlet port

Expansion of air return port area

Low power consumption
20 W*

*: 018 model

Optional parts

- IR Receiver Unit: UTY-TRHX
- Cassette Grille: UTG-USGA-W
- External Power Supply Unit: UTZ-GXXC



Specifications

Model name		AUXS018GLEH		AUXS024GLEH	
Power source		Single phase, ~230V, 50Hz			
Capacity	Cooling	5.60		7.10	
	Heating	6.30		8.00	
Input power		20/28		34 / 43	
Airflow rate*	High	750 / 870		950 / 1,040	
	Med-High	710 / 830		890 / 990	
	Med	690 / 780		860 / 930	
	Med-Low	660 / 740		810 / 880	
	Low	630 / 700		770 / 840	
	Quiet	540 / 540		540 / 540	
Sound pressure level*	High	38 / 41		43 / 46	
	Med-High	36 / 40		42 / 45	
	Med	35 / 39		41 / 43	
	Med-Low	35 / 37		40 / 42	
	Low	33 / 36		38 / 40	
Quiet	29 / 29		29 / 29		
Dimensions (H × W × D)		mm 200 × 1,240 × 500		200 × 1,240 × 500	
Weight		kg 25		25	
Connection pipe diameter	Liquid (Flare)	6.35		9.52	
	Gas (Flare)	12.70		15.88	
Drain hose diameter (I.D./O.D.)		25 / 32			
Cassette Grille	Model name		UTG-USGA-W		
	Dimensions (H×W×D)		mm 85 × 1,350 × 580		
	Weight		kg 11.5		

Note : Specifications are based on the following conditions.

Cooling : Indoor temperature of 27°CDB / 19°CWB, and outdoor temperature of 35°CDB / 24°CWB.
 Heating : Indoor temperature of 20°CDB / (15°CWB), and outdoor temperature of 7°CDB / 6°CWB.
 Pipe length : 7.5 m; Height difference between outdoor unit and indoor unit : 0 m. Voltage : 230 [V].

*: This value is "cooling operation / heating operation".

Dimensions (Unit: mm)

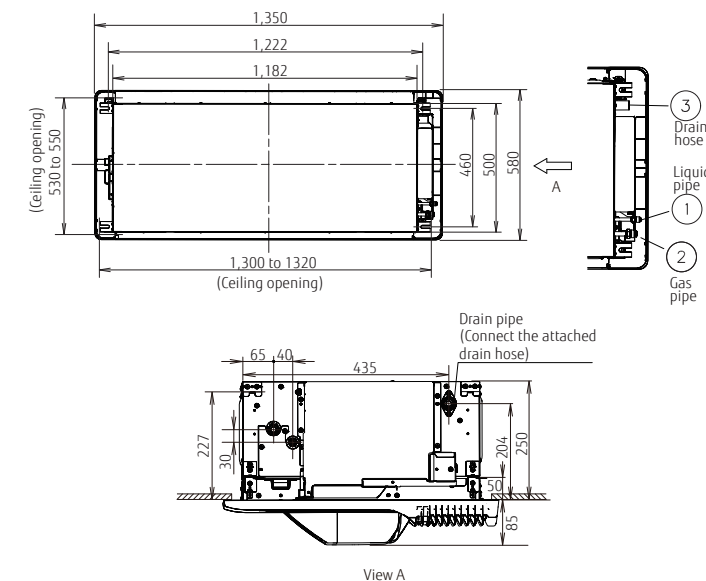

4-way Flow Compact Cassette (Grid type)

Models

AUXB007GLEH / AUXB009GLEH / AUXB012GLEH
 AUXB014GLEH / AUXB018GLEH / AUXB024GLEH
 AUXB09GATH / AUXB12GATH / AUXB14GATH
 AUXB18GATH / AUXB24GATH



Feature

Compact and stylish panel design

Compact and stylish panel design fits the grid type ceiling. It is a linear design suitable for grid shape of 620 mm × 620 mm grid ceiling.

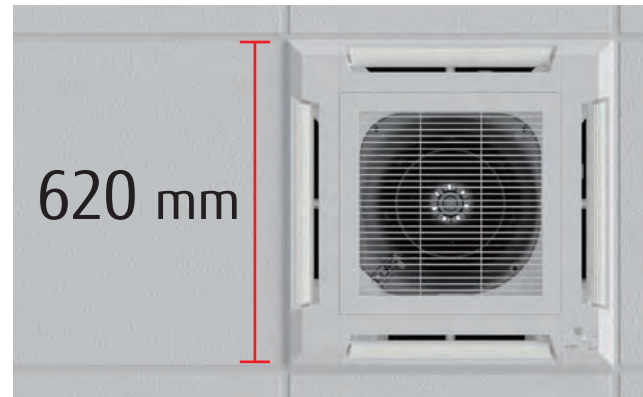

Flexible installation

It is suitable for ceiling of grid type and it has high degree of freedom of installation and it can be installed beside lighting and ventilation opening.



Flexible installation

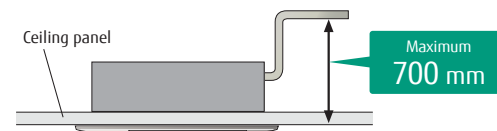

Easy maintenance

Maintenance is easier by removing the ceiling panel next to the grill, maintenance can be done, and new installation of inspection hole is unnecessary, so construction costs can be suppressed.

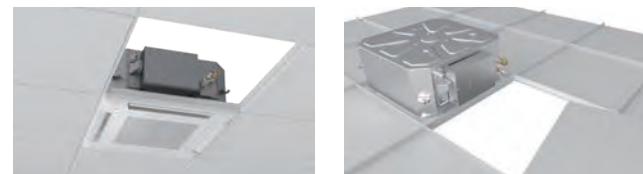

The air inlet grill can be installed in various directions, so maintenance is easy.



High ceiling mode

The compact cassette can be installed up to a height of 3.0 m (12/14/18/24).

Model code	The maximum height from floor to ceiling (m)	
	Standard mode	High ceiling mode
7	2.7	-
9	2.7	-
12	2.7	3.0
14	2.7	3.0
18	2.7	3.0
24	2.7	3.0

Optional parts

- Air Outlet Shutter Plate: UTR-YDZB
- Fresh Air Intake Kit: UTZ-VXAA
- Insulation Kit for High Humidity: UTZ-KXGC
- Cassette Grille: UTG-UFGE-W
- External Power Supply Unit: UTZ-GXXC (AUXB***GLEH)

Specifications

Model name	AUXB007GLEH	AUXB009GLEH AUXB09GATH	AUXB012GLEH AUXB12GATH	AUXB014GLEH AUXB14GATH	AUXB018GLEH AUXB18GATH	AUXB024GLEH AUXB24GATH	
Power source	Single phase, ~230V, 50Hz						
Capacity	Cooling	2.2	2.8	3.6	4.5	5.6	7.1
	Heating	2.8	3.2	4.1	5.0	6.3	8.0
Input power	W	25	25	29	35	36	84
Airflow rate	High	540	550	600	680	710	1,030
	Med-High*1	500	520	560	620	660	910
	Med	460	480	520	560	590	790
	Med-Low*1	420	440	480	500	520	680
	Low	390	400	430	440	460	560
	Quiet*1	350	350	390	390	400	450
Sound pressure level	High	34	35	37	38	41	50
	Med-High*1	32	33	34	37	39	46
	Med	30	31	33	34	36	43
	Med-Low*1	28	29	31	32	33	39
	Low	27	27	29	30	30	35
	Quiet*1	25	25	27	27	27	30
Dimensions (H × W × D)	mm	245 × 570 × 570	245 × 570 × 570	245 × 570 × 570	245 × 570 × 570	245 × 570 × 570	245 × 570 × 570
Weight	kg	15	15	15	15	17	17
Connection pipe diameter	Liquid (Flare)	6.35	6.35	6.35	6.35	6.35 / 9.52*2	9.52
	Gas (Flare)	9.52 / 12.70*2	9.52 / 12.70*2	12.70	12.70	12.70 / 15.88*2	15.88
Drain hose diameter (I.D./O.D.)		25 / 32					
Cassette Grille	Model name	UTG-UFGE-W / UTG-UFGE-W					
	Dimensions (H×W×D)	49 × 620 × 620 / 49 × 700 × 700					
	Weight	2.3 / 2.6					

Note : Specifications are based on the following conditions.

Cooling : Indoor temperature of 27°CDB / 19°CWB, and outdoor temperature of 35°CDB / 24°CWB.
 Heating : Indoor temperature of 20°CDB / (15°CWB), and outdoor temperature of 7°CDB / 6°CWB.
 Pipe length : 7.5 m; Height difference between outdoor unit and indoor unit : 0 m. Voltage : 230 [V].

*1: AUXB***GLEH only
 *2: GLEH / GATH

Dimensions (Unit: mm)

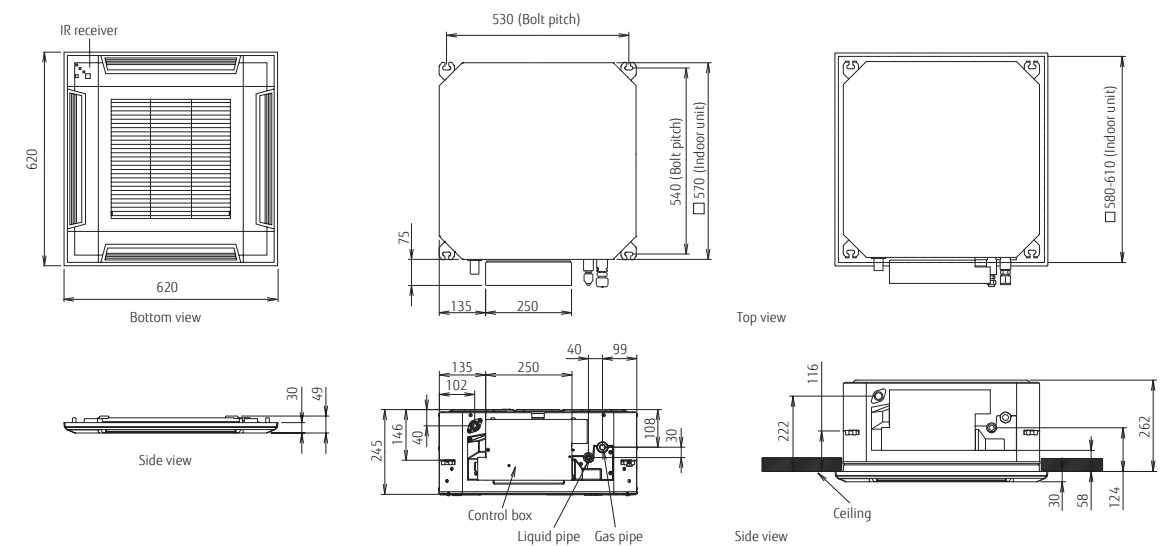

4-way Flow Compact Cassette (Standard type)

Models

AUXB007GLEH / AUXB009GLEH / AUXB012GLEH
 AUXB014GLEH / AUXB018GLEH / AUXB024GLEH
 AUXB09GATH / AUXB12GATH / AUXB14GATH
 AUXB18GATH / AUXB24GATH



Compact design

The worlds first 24,000 Btu model in the compact cassette category.
 (Easy installed by taking off ceiling panel of 600 x 600 size)



High lift drain pump

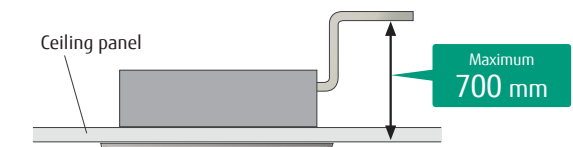

Optional parts

Air outlet shutter plate : UTR-YDZB
 Insulation kit for high humidity: UTZ-KXGC
 Fresh air intake kit: UTZ-VXAA
 Cassette Grille: UTG-UFGC-W
 External Power Supply Unit: UTZ-GXXC (AUXB***GLEH)



Features

2-stage turbo fan

High efficiency design through 2-stage structure

Air distribution evenly spread across the heat exchanger is possible due to the new 2-stage turbo fan which produces two separate airflow streams.

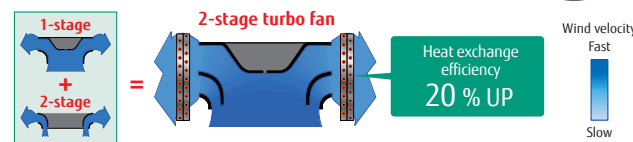

Previous turbo fan

In the case of a previous fan, the air outlet range was narrow as the airflow moved to the motor side which meant the velocity of air passing through the heat exchanger was uneven.



Quiet operation

Optimisation of wing form (laminar wing type) and wing number (7 blades each)

Designed by CFD-analysis (fluid) simulations

Adoption of laminar wing

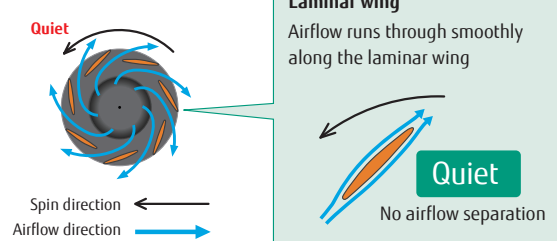

Improvement of the airflow distribution

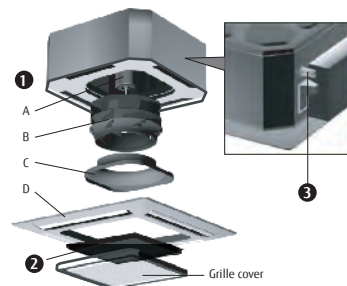

1 Maintenance of fan motor and fan

Maintenance of the fan motor and fan can be done easily after taking off the panel as the bell mouth of the fan can be removed easily.

A : Fan motor B : 2-stage turbo fan
 C : Bell-mouth D : Panel

2 Air filter : standard equipment

3 Adaptation of transparent drainage parts

During installation, maintenance and operation, the drain pump and kit can be checked easily.

High ceiling mode

The compact cassette can be installed up to a height of 3.0 m (12/14/18/24).

Model code	The maximum height from floor to ceiling (m)	
	Standard mode	High ceiling mode
7	2.7	-
9	2.7	-
12	2.7	3.0
14	2.7	3.0
18	2.7	3.0
24	2.7	3.0



Specifications

Model name	AUXB007GLEH	AUXB009GLEH AUXB09GATH	AUXB012GLEH AUXB12GATH	AUXB014GLEH AUXB14GATH	AUXB018GLEH AUXB18GATH	AUXB024GLEH AUXB24GATH
Power source	Single phase, ~230V, 50Hz					
Capacity	Cooling	2.2	2.8	3.6	4.5	5.6
	Heating	2.8	3.2	4.1	5.0	6.3
Input power	W	25	25	29	35	36
Airflow rate	High	540	550	600	680	710
	Med-High*1	500	520	560	620	660
	Med	460	480	520	560	590
	Med-Low*1	420	440	480	500	520
	Low	390	400	430	440	460
	Quiet*1	350	350	390	390	400
Sound pressure level	High	34	35	37	38	41
	Med-High*1	32	33	34	37	39
	Med	30	31	33	34	36
	Med-Low*1	28	29	31	32	33
	Low	27	27	29	30	30
	Quiet*1	25	25	27	27	27
Dimensions (H x W x D)	mm	245 x 570 x 570	245 x 570 x 570	245 x 570 x 570	245 x 570 x 570	245 x 570 x 570
Weight	kg	15	15	15	17	17
Connection pipe diameter	Liquid (Flare)	6.35	6.35	6.35	6.35	6.35 / 9.52*2
	Gas (Flare)	9.52 / 12.70*2	9.52 / 12.70*2	12.70	12.70	12.70 / 15.88*2
Drain hose diameter (I.D./O.D.)		25 / 32				
Cassette Grille	Model name	UTG-UFGC-W / UTG-UFGC-W				
	Dimensions (HxWxD)	49 x 620 x 620 / 49 x 700 x 700				
	Weight	2.3 / 2.6				

Note : Specifications are based on the following conditions.

Cooling : Indoor temperature of 27°CDB / 19°CWB, and outdoor temperature of 35°CDB / 24°CWB.
 Heating : Indoor temperature of 20°CDB / (15°CWB), and outdoor temperature of 7°CDB / 6°CWB.
 Pipe length : 7.5 m; Height difference between outdoor unit and indoor unit : 0 m. Voltage : 230 [V].

*1: AUXB***GLEH only

*2: GLEH / GATH

Dimensions (Unit: mm)

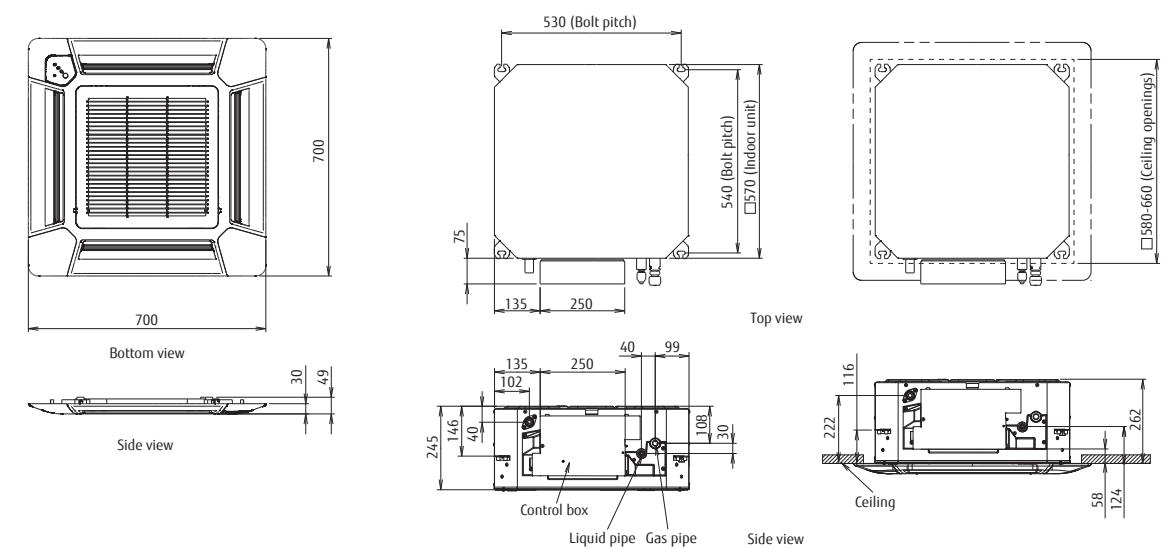

4-way Flow Cassette (Slim type)

Models
AUXD18GALH / AUXD24GALH



Feature

High efficiency turbo fan with 3-dimensional blade

High efficiency airflow distribution has been achieved by the introduction of a 3 dimensional blade which increases the air passing over the heat exchanger.

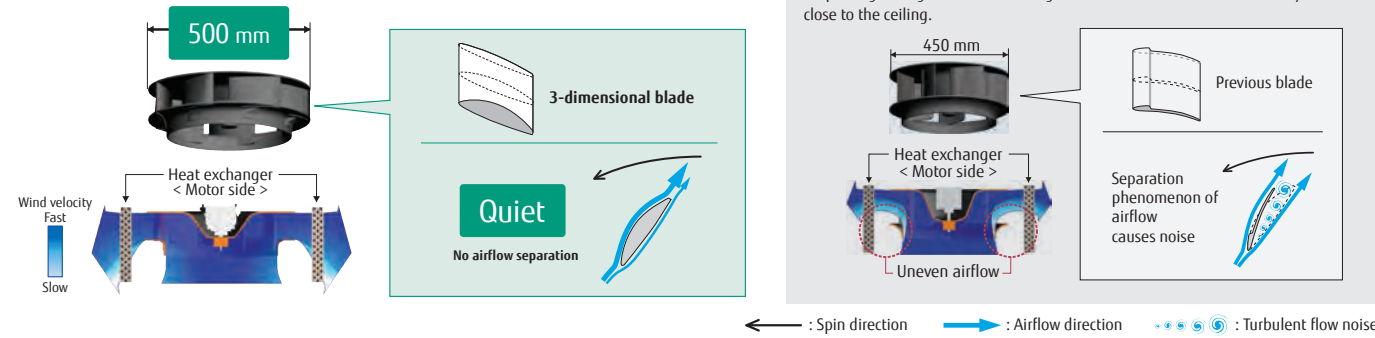

Improvement of the airflow distribution

The louver design distributes air leaving a space between the chassis and the ceiling allowing far and wide airflow distribution.

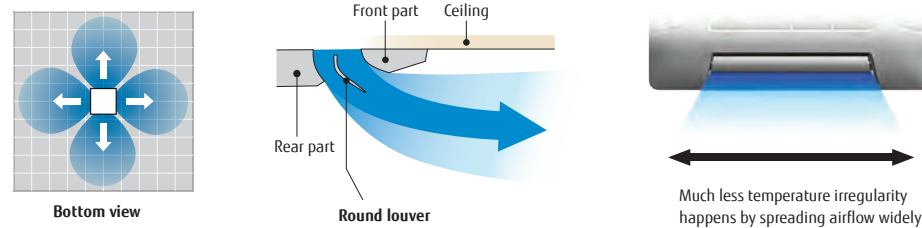

Adjustment of hanger position is possible after installation

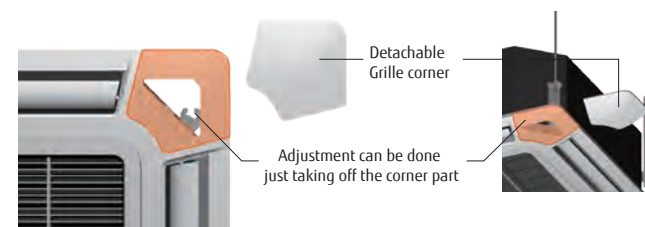

High ceiling mode

This cassette can be installed up to a height of 3.5 m.

Model code	The maximum height from floor to ceiling (m)	
	Standard mode	High ceiling mode
18	3.0	3.5
24	3.0	3.5

One way installation

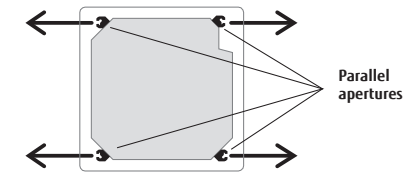

High lift drain pump

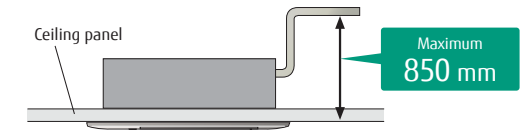

Optional parts

IR Receiver Unit :	UTY-LRHGB1
Air Outlet Shutter Plate :	UTR-YDZK
Panel Spacer :	UTG-BKXA-W
Insulation Kit for High Humidity :	UTZ-KXRA
Wide Panel :	UTG-AKXA-W
Fresh Air Intake Kit :	UTZ-VXRA
Cassette Grille :	UTG-UGGA-W

Specifications

Model name		AUXD18GALH	AUXD24GALH
Power source		Single phase, ~230V, 50Hz	
Capacity	Cooling	5.6	7.1
	Heating	6.3	8.0
Input power		39	46
Airflow rate	High	1,150	1,280
	Med	940	1,040
	Low	870	870
Sound pressure level	High	36	38
	Med	30	33
	Low	29	29
Dimensions (H × W × D)		246 × 840 × 840	246 × 840 × 840
Weight		22	22
Connection pipe diameter	Liquid (Flare)	9.52	9.52
	Gas (Flare)	15.88	15.88
Drain hose diameter (I.D./O.D.)		25 / 32	
Cassette Grille		UTG-UGGA-W	
Dimensions (H×W×D)		50 × 950 × 950	
Weight		5.5	

Note : Specifications are based on the following conditions.
Cooling : Indoor temperature of 27°CDB / 19°CWB, and outdoor temperature of 35°CDB / 24°CWB.
Heating : Indoor temperature of 20°CDB / (15°CWB), and outdoor temperature of 7°CDB / 6°CWB.
Pipe length : 7.5 m; Height difference between outdoor unit and indoor unit : 0 m. Voltage : 230 [V].

Dimensions (Unit : mm)

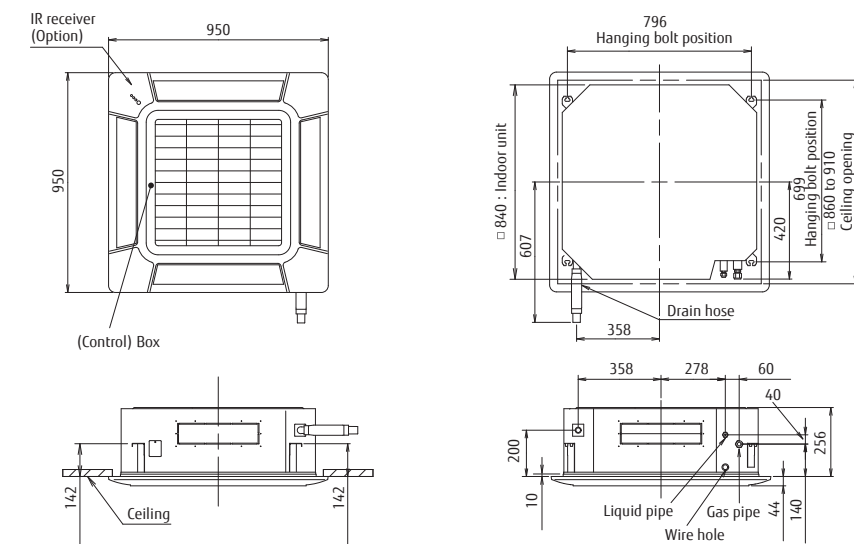

4-way Flow Cassette (Large type)

Models

AUXA18GALH / AUXA24GALH / AUXA30GALH
 AUXA34GALH / AUXA36GALH / AUXA45GALH
 AUXA54GALH



Feature

High efficiency turbo fan with 3-dimensional blade

High efficiency airflow distribution has been achieved by the introduction of a 3 dimensional blade which increases the air passing over the heat exchanger.

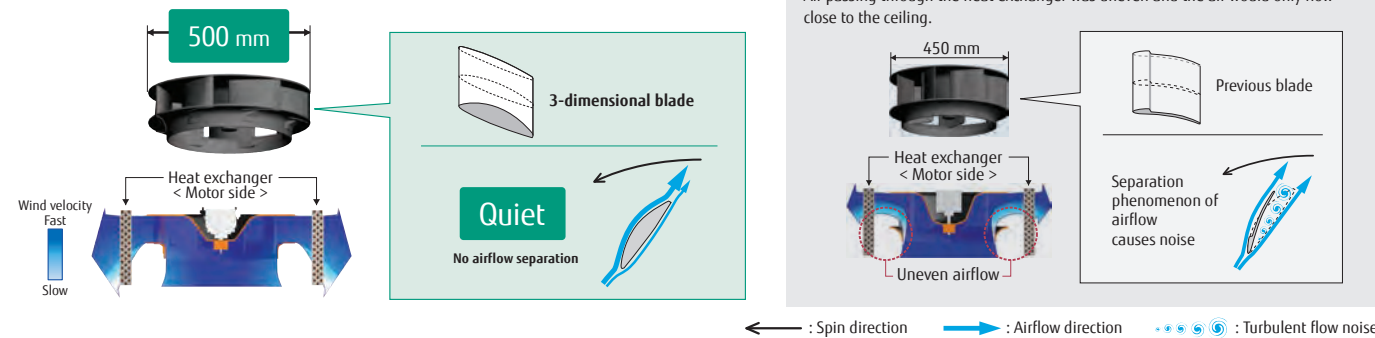

Improvement of the airflow distribution

The louver design distributes air leaving a space between the chassis and the ceiling allowing far and wide airflow distribution.

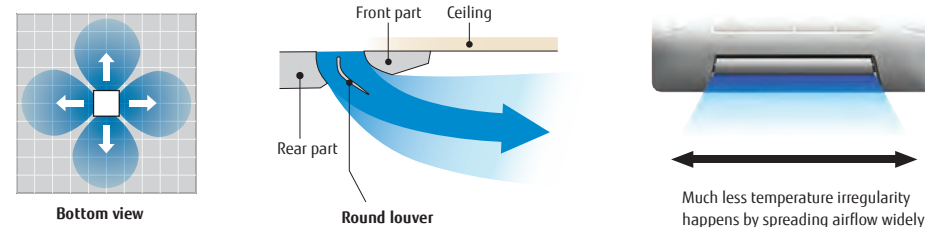

Adjustment of hanger position is possible after installation

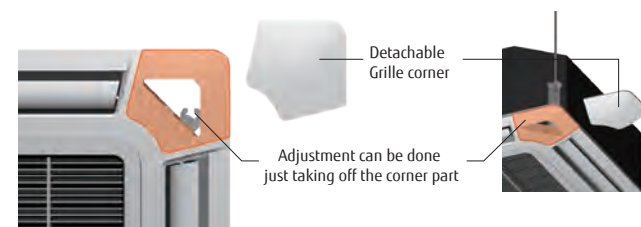

High ceiling mode

This cassette can be installed up to a height of 4.2 m (36/45/54).

Model code	The maximum height from floor to ceiling (m)	
	Standard mode	High ceiling mode
30	3.2	3.6
34	3.2	3.6
36	3.2	4.2
45	3.2	4.2
54	3.2	4.2

One way installation

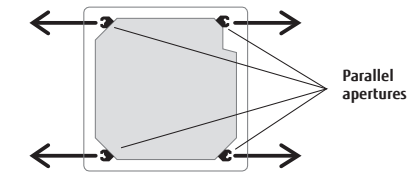

High lift drain pump

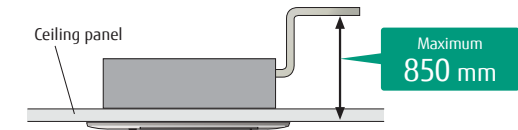

Optional parts

- IR Receiver Unit : UTY-LRHGB1
- Air Outlet Shutter Plate : UTR-YDZK
- Panel Spacer : UTG-BKXA-W
- Insulation Kit for High Humidity : UTZ-KXRA
- Wide Panel : UTG-AKXA-W
- Fresh Air Intake Kit : UTZ-VXRA
- Cassette Grille : UTG-UGGA-W

Specifications

Model name	AUXA18GALH	AUXA24GALH	AUXA30GALH	AUXA34GALH	AUXA36GALH	AUXA45GALH	AUXA54GALH
Power source	Single phase, ~230V, 50Hz						
Capacity	Cooling	5.6	7.1	9.0	10.0	11.2	12.5
	Heating	6.3	8.0	10.0	11.2	12.5	14.0
Input power	51	51	59	77	80	99	119
Airflow rate	High	1,420	1,420	1,600	1,750	1,800	1,900
	Med	1,230	1,230	1,300	1,300	1,300	1,370
	Low	1,100 / 1,000*	1,100 / 1,000*	1,100	1,100	1,100	1,100
Sound pressure level	High	40	40	40	43	44	46
	Med	36	36	38	38	38	39
	Low	33 / 31*	33 / 31*	33	33	33	33
Dimensions (H × W × D)	288 × 840 × 840	288 × 840 × 840	288 × 840 × 840	288 × 840 × 840	288 × 840 × 840	288 × 840 × 840	288 × 840 × 840
Weight	27	27	27	27	27	27	27
Connection pipe diameter	Liquid (Flare)	9.52	9.52	9.52	9.52	9.52	9.52
	Gas (Flare)	15.88	15.88	15.88	15.88	19.05	19.05
Drain hose diameter (I.D./O.D.)	25 / 32						
Cassette Grille	Model name	UTG-UGGA-W					
	Dimensions (H×W×D)	50 × 950 × 950					
	Weight	5.5					

Note : Specifications are based on the following conditions.
 Cooling : Indoor temperature of 27°CDB / 19°CWB, and outdoor temperature of 35°CDB / 24°CWB.
 Heating : Indoor temperature of 20°CDB / (15°CWB), and outdoor temperature of 7°CDB / 6°CWB.
 Pipe length : 7.5 m; Height difference between outdoor unit and indoor unit : 0 m. Voltage : 230 [V].

*: This value is under cooling operation.

Dimensions (Unit : mm)

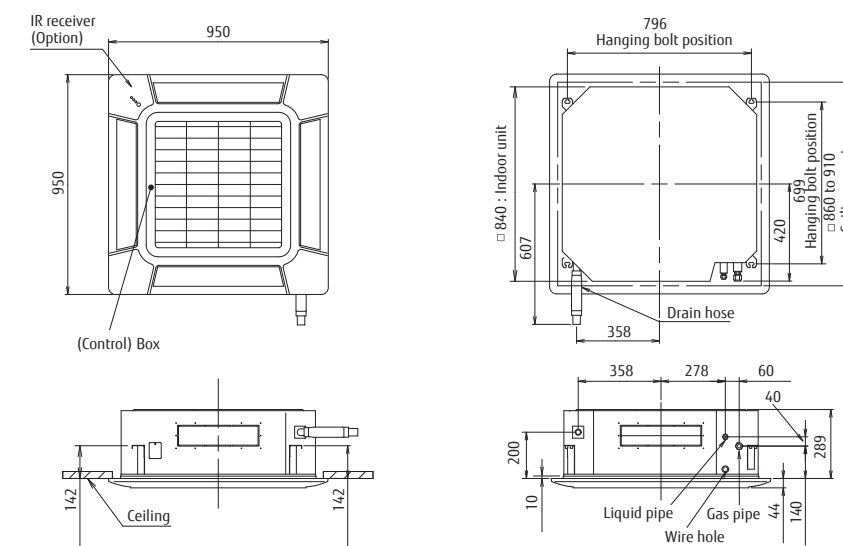

Circular Flow Cassette

Models (Slim type)
 AUXM018GLEH / AUXM024GLEH / AUXM030GLEH
 AUXM018GTAH / AUXM024GTAH

Models (Large type)
 AUXK018GLEH / AUXK024GLEH / AUXK030GLEH
 AUXK034GLEH / AUXK036GLEH / AUXK045GLEH
 AUXK054GLEH
 AUXK030GTAH / AUXK036GTAH / AUXK045GTAH
 AUXK054GTAH

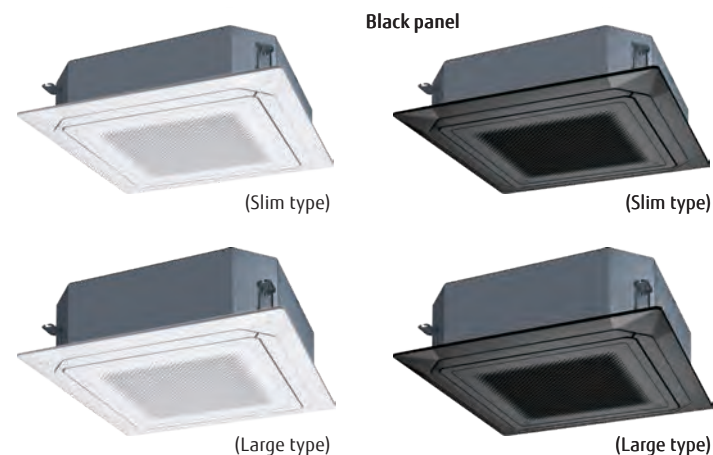

Feature

Unique Circular Flow design

New Cassette type realizes Circular Flow to blow large airflow in 360° direction by mounting high performance DC fan motor, new turbo fan and unique seamless airflow louver design.

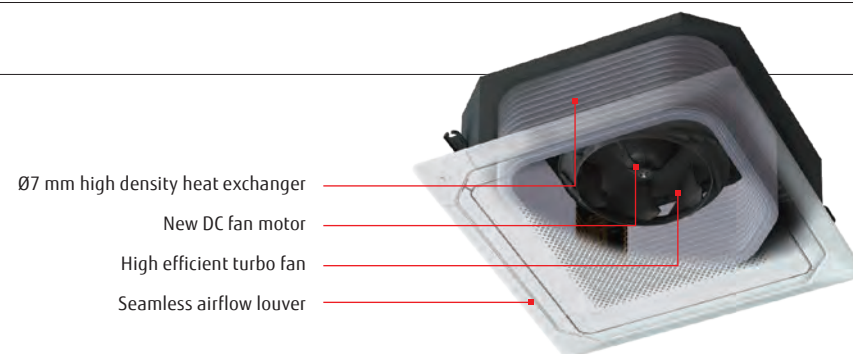

Uniform temperature air conditioning

Achieve a comfortable air conditioning spread to every corner of the room by circular flow & wide vertical airflow.

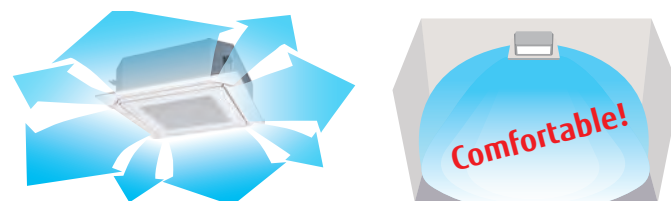

Individual louver control

Each louver can be set individually by Touch Panel Wired Remote Controller to enjoy the comfort of different directional airflows according to various room layouts.

* Touch Panel Wired RC (UTY-RNRGZ5) and Central Remote Controller(UTY-DCGGZ2) only



Comfortable air conditioning by preventing direct blowing of cold air and by providing swinging air flow simultaneously.



Efficient air conditioning based on the room layout

Occupancy sensor increases more energy saving

Energy saving operation starts automatically by detecting the motion of a person. 2 modes of save operation mode and stop mode can be selected.

* Touch Panel Wired RC (UTY-RNRGZ5) and Central Remote Controller(UTY-DCGGZ2) only



Occupancy sensor (Option)

2 modes can be selected

Auto saving
 Power is saved while people are away.

Auto OFF
 Operation stops after people go out.

Optional parts

- Occupancy Sensor Kit: UTY-SHZXC
- Wide Panel: UTG-AKXA-W
- Panel Spacer: UTG-BKXA-W
- Fresh Air Intake Kit: UTZ-VXRA
- Air Outlet Shutter Plate: UTR-YDZK
- Insulation Kit for High Humidity: UTZ-KXRA
- Cassette Grille: UTG-UKGC-W, UTG-UKGA-B (Black)
- External Power Supply Unit: UTZ-GXXC (AUXM***GLEH, AUXK***GLEH)
- IR Receiver unit: UTY-LBHxD



Specifications

Model name	AUXM018GLEH AUXM018GTAH	AUXM024GLEH AUXM024GTAH	AUXM030GLEH	AUXK018GLEH	AUXK024GLEH	AUXK030GLEH AUXK030GTAH	AUXK034GLEH AUXK036GTAH	AUXK036GLEH AUXK036GTAH	AUXK045GLEH AUXK045GTAH	AUXK054GLEH AUXK054GTAH	
Power source	Single phase, ~230V, 50Hz										
Capacity	Cooling	5.6	7.1	9.0	5.6	7.1	9.0	10.0	11.2	12.5	14.0
	Heating	6.3	8.0	10.0	6.3	8.0	10.0	11.2	12.5	14.0	16.0
Input power	Cooling	20	25	49	40	40	47	47	61	89	116
	Heating	1,050	1,120	1,470	1,420	1,420	1,440	1,440	1,620	1,820	2,040
Airflow rate	High	930	1,050	1,160	1,360	1,360	1,400	1,400	1,500	1,590	1,800
	Med-High	900	930	1,070	1,300	1,300	1,340	1,340	1,400	1,500	1,590
	Med	870	900	930	1,270	1,270	1,300	1,300	1,340	1,400	1,440
	Med-Low	810	870	900	1,200	1,200	1,280	1,280	1,280	1,300	1,300
	Low	780	780	780	1,150	1,150	1,150	1,150	1,150	1,150	1,150
Sound pressure level	High	33	35	40	38	38	39	39	41	44	47
	Med-High	32	33	36	37	37	38	38	40	42	45
	Med	31	32	34	36	36	37	37	38	40	42
	Med-Low	30	31	32	35	35	36	36	37	38	39
	Low	29	30	31	34	34	35	35	35	36	36
Quiet	28	28	28	33	33	33	33	33	33	33	
Dimensions (H × W × D)	mm	246×840×840	246×840×840	246×840×840	288×840×840	288×840×840	288×840×840	288×840×840	288×840×840	288×840×840	288×840×840
Weight	kg	24.0	24.5	24.5	26.5	26.5	29.5	29.5	29.5	29.5	29.5
Connection pipe diameter	Liquid (Flare)	6.35	9.52	9.52	6.35	9.52	9.52	9.52	9.52	9.52	9.52
	Gas (Flare)	12.70	15.88	15.88	12.70	15.88	15.88	15.88	15.88	15.88	15.88
Drain hose diameter (I.D./O.D.)		25 / 32									
Cassette Grille	Model name	UTG-UKGC-W / UTG-UKGA-B (Black)									
	Dimensions (H×W×D)	53×950×950									
	Weight	6.0									

Note : Specifications are based on the following conditions.
 Cooling : Indoor temperature of 27°CDB / 19°CWB, and outdoor temperature of 35°CDB / 24°CWB.
 Heating : Indoor temperature of 20°CDB / (15°CWB), and outdoor temperature of 7°CDB / 6°CWB.
 Pipe length : 7.5 m; Height difference between outdoor unit and indoor unit : 0 m. Voltage : 230 [V].

Dimensions (Unit: mm)

Models: AUXM018 / AUXM024 / AUXM030

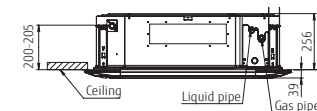
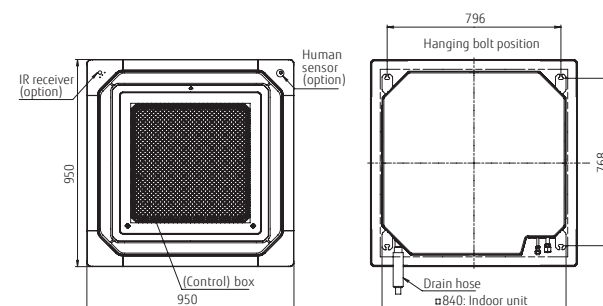

Models: AUXK018 / AUXK024 / AUXK030 / AUXK034 / AUXK036 / AUXK045 / AUXK054

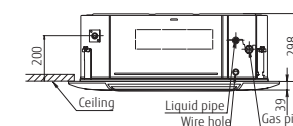
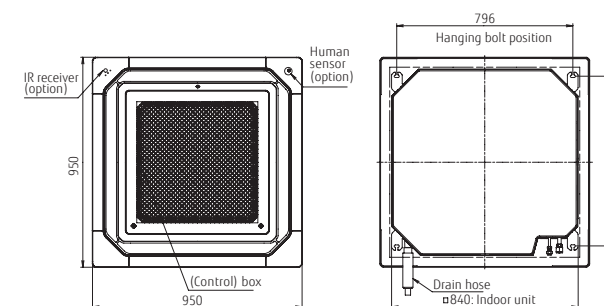

Mini Duct

Models (With drain pump)
 ARXK007GLGH / ARXK009GLGH / ARXK012GLGH
 ARXK014GLGH / ARXK018GLGH / ARXK024GLGH

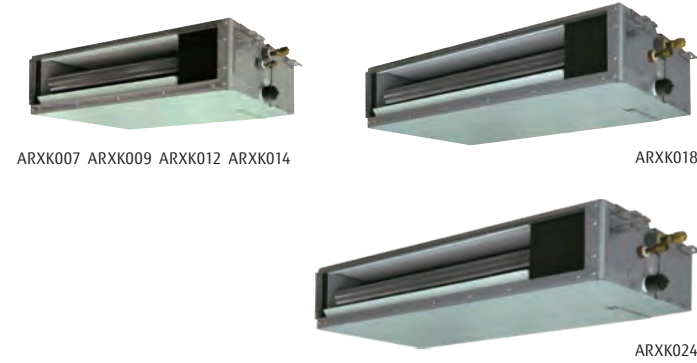

Feature

Large living space available

- Installation space can be reduced down to minimum depth 450 mm height 198 mm and compact design
- Minimum size: Depth 450 mm, Height 198 mm Volume 30 % down compared with current model
- Lightweight: 16 kg 10 % down

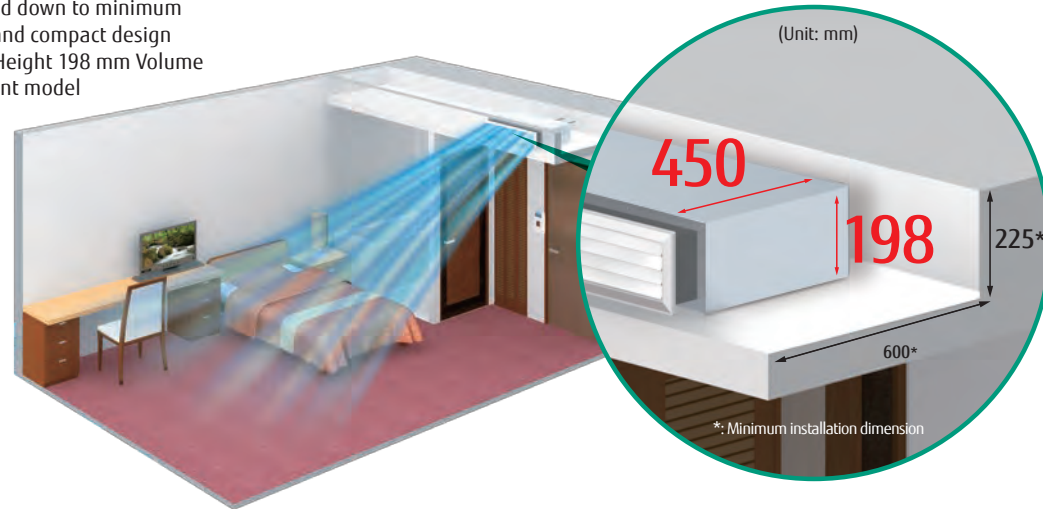

Optimum airflow path and low noise operation

Low noise is realized drastically by stabilized airflow design

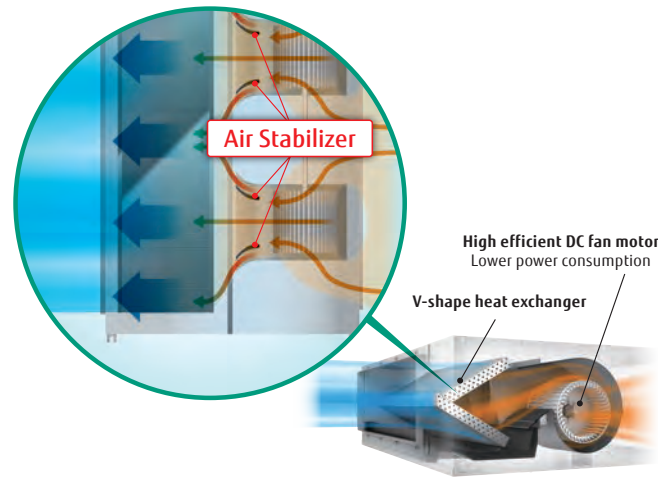

Easy design and maintenance for drain

By using the DC fan motor, it is possible to change the static pressure range from 0 to 50 Pa*.

The change of static pressure range is possible by remote controller.
 *: 0 to 30 Pa. (12)

Built-in drain pump as standard :
 Maintenance is easy

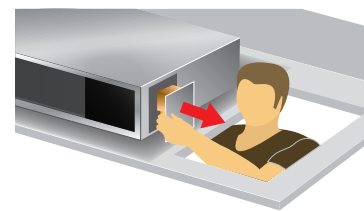

Parts can be replaced from the side of the body where maintenance is easier

6-speed control*

Multistep airflow speed control allows this model to install in a quiet location.

Low noise
21 dB(A)
 at 7/9 models

6-Step Speed

- High
- Med-High
- Med
- Med-Low
- Low
- Quiet



* Compatible Remote Controller is as follows:
 UTY-RNRG25 / UTY-RLRG / UTY-RSRG / UTY-RHRG / UTY-DCCG22 / UTY-DTGG21 / UTY-ALGX21 / UTY-APGX21

Auto Louver Grille Kit (Option)



- Thin design provides a comfortable living environment over a wide area.
- Automatic louver grille provides comfortable air conditioning all the way down to the floor and matches the interior design well. (Optional)

Optional parts

- Remote Sensor Unit : UTY-XSZXZ1
- IR Receiver Unit : UTY-TRHX
- Auto Louver Grille Kit : UTD-GXTA-W (for 7/9/12/14 models)
 UTD-GXTB-W (for 18 model)
 UTD-GXTC-W (for 24 model)
- External power supply unit : UTZ-GXXC

Specifications

Model name			ARXK007GLGH	ARXK009GLGH	ARXK012GLGH	ARXK014GLGH	ARXK018GLGH	ARXK024GLGH
Power source			Single phase, ~230V, 50Hz					
Capacity	Cooling	kW	2.2	2.8	3.6	4.5	5.6	7.1
	Heating	kW	2.8	3.2	4.0	5.0	6.3	8.0
Input power	W		28	28	35	66	73	80
Airflow rate	High	m ³ /h	460	460	550	760	930	1,160
	Med-High		440	440	520	660	840	1,060
	Med		420	420	480	560	740	960
	Med-Low		400	400	450	490	640	860
	Low		370	370	410	410	540	750
Quiet	340	340	340	340	470	610		
Static pressure range	Pa		0 to 30	0 to 30	0 to 30	0 to 50	0 to 50	0 to 50
Standard static pressure	High	Pa	10	10	10	15	15	15
	Med-High		26	26	29	34	33	32
Sound pressure level	Med	dB (A)	25	25	27	31	30	30
	Med-Low		24	24	26	28	28	28
	Low		23	23	25	26	26	27
	Quiet		22	22	24	24	24	25
	Quiet		21	21	22	22	22	22
Dimensions (H × W × D)	mm		198 × 700 × 450	198 × 700 × 450	198 × 700 × 450	198 × 700 × 450	198 × 900 × 450	198 × 1,100 × 450
Weight*	kg		15.5 / 15.0	15.5 / 15.0	16.0 / 15.5	16.0 / 15.5	19.0 / 18.5	22.5 / 22.0
Connection pipe diameter	Liquid (Flare)	mm	6.35	6.35	6.35	6.35	6.35	9.52
	Gas (Flare)		9.52	9.52	12.70	12.70	12.70	15.88
Drain hose diameter (I.D./O.D.)			25 / 32					

Note : Specifications are based on the following conditions.
 Cooling : Indoor temperature of 27°CDB / 19°CWB, and outdoor temperature of 35°CDB / 24°CWB.
 Heating : Indoor temperature of 20°CDB / (15°CWB), and outdoor temperature of 7°CDB / 6°CWB.
 Pipe length : 7.5 m; Height difference between outdoor unit and indoor unit : 0 m. Voltage : 230 [V].

Dimensions (Unit: mm)

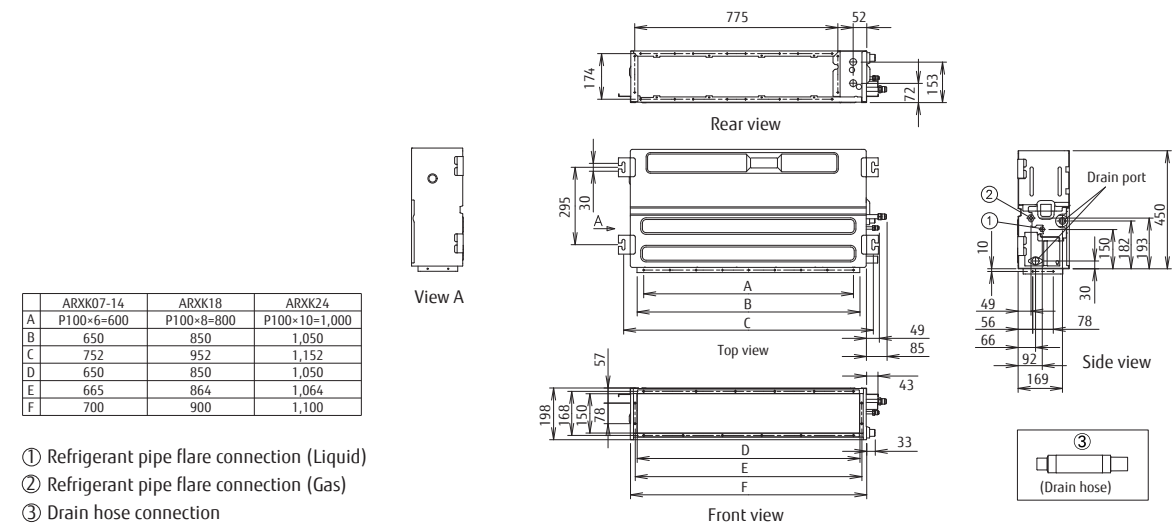

Low Static Pressure Duct / Concealed Floor

Models

ARXB07GALH / ARXB09GALH / ARXB12GALH
ARXB14GALH / ARXB18GALH

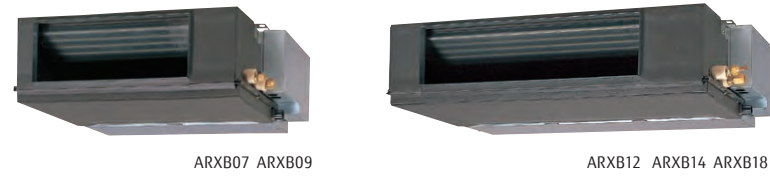

Concealed Floor



Feature

Low noise level

A low noise level has been achieved for each capacity

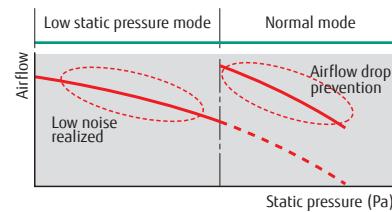

Model	7	9	12	14	18
Static pressure range	Pa 0 to 50				
Noise level (Low speed)	24	27	25	30	30

Compact design

Ultra-slim duct air conditioner for easy installation

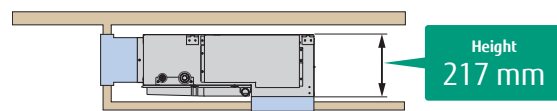

Slim size (217 mm) allows installation even where the space above the ceiling is narrow.

Two-direction drain piping

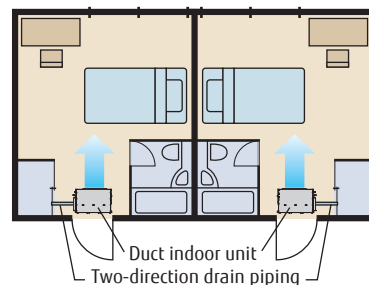

Air-intake

Air intake direction can be selected to match the installation site.

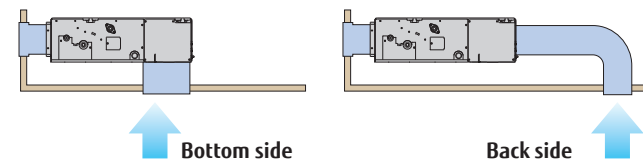

Flexible installation

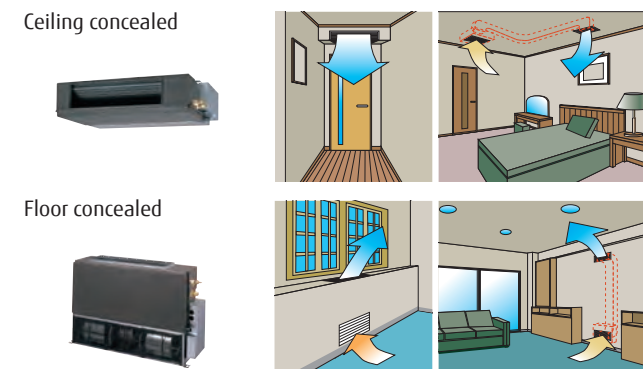

Filter (Accessory)

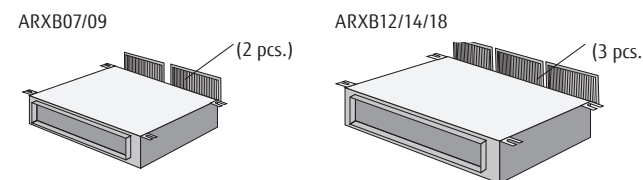

Optional parts

Remote Sensor Unit : UTY-XSZXZ1
IR Receiver Unit : UTB-YWC
Drain Pump Unit : UTZ-PX1BBA



Specifications

Model name	ARXB07GALH	ARXB09GALH	ARXB12GALH	ARXB14GALH	ARXB18GALH	
Power source	Single phase, ~230V, 50Hz					
Capacity	Cooling	2.2	2.8	3.6	4.5	5.6
	Heating	2.8	3.2	4.0	5.0	6.3
Input power	46	55	63	90	96	
Airflow rate	High	370	440	590	800	890
	Med	310	370	500	750	810
	Low	280	340	450	700	730
Static pressure range	Pa 0 to 50					
Standard static pressure	25	25	25	25	25	
Sound pressure level	High	29	31	30	33	36
	Med	26	29	28	32	34
	Low	24	27	25	30	30
Dimensions (H x W x D)	mm 217 x 663 x 595					
Weight	kg 15					
Connection pipe diameter	Liquid (Flare)	6.35	6.35	6.35	6.35	9.52
	Gas (Flare)	mm 12.70				
Drain hose diameter (I.D./O.D.)	25 / 32					

Note : Specifications are based on the following conditions.
Cooling : Indoor temperature of 27°CDB / 19°CWB, and outdoor temperature of 35°CDB / 24°CWB.
Heating : Indoor temperature of 20°CDB / (15°CWB), and outdoor temperature of 7°CDB / 6°CWB.
Pipe length : 7.5 m; Height difference between outdoor unit and indoor unit : 0 m. Voltage : 230 [V].

Dimensions (Unit: mm) (): AR07/AR09

*Service accessibility must be allowed for when installing the product. Please consult the installation manual for the necessary service access size.

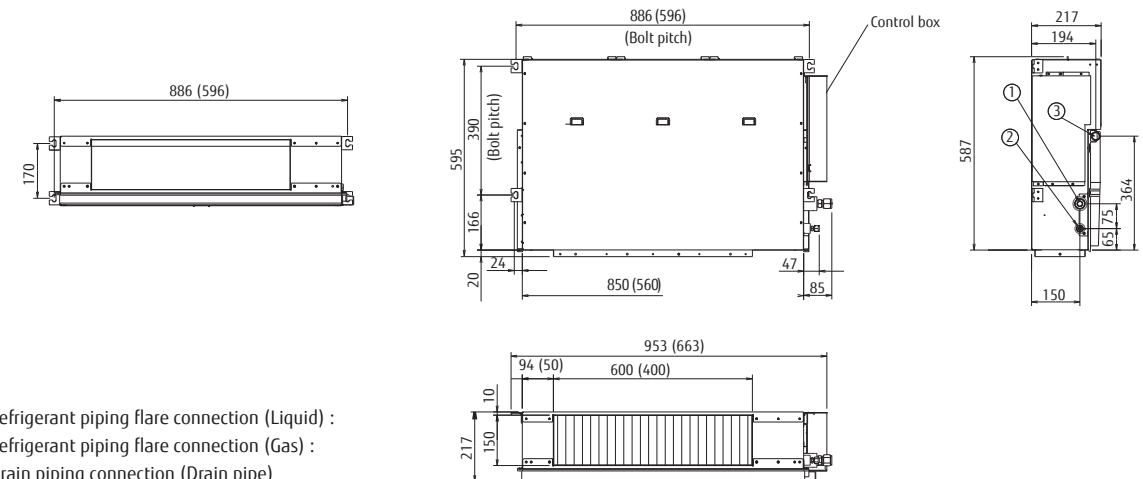

- ① Refrigerant piping flare connection (Liquid) :
- ② Refrigerant piping flare connection (Gas) :
- ③ Drain piping connection (Drain pipe)

Slim Duct / Slim Concealed Floor

Models (With drain pump)
 ARXD007GLEH / ARXD009GLEH / ARXD012GLEH
 ARXD014GLEH / ARXD018GLEH / ARXD024GLEH
 ARXD07GATH / ARXD09GATH / ARXD12GATH
 ARXD14GATH / ARXD18GATH / ARXD24GATH



Feature

Slim design

With a slim indoor design, this indoor can be installed in narrow ceiling spaces.

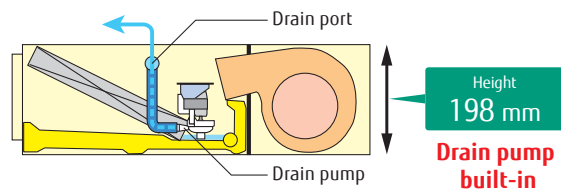

Selectable with a wide range of static pressure

By using DC fan motor, it is possible to change of static pressure range 0 to 90 Pa. The change of static pressure range is possible by remote controller.



Static pressure range
0 to 90 Pa

*24 model is 0 to 50 Pa

High lift drain pump

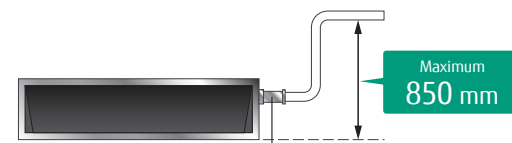

Drain hose is standard accessory

Air-intake

Air intake direction can be selected to match the installation site.

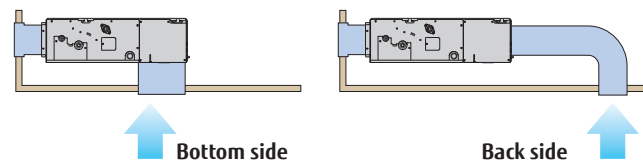

Filter (Accessory)

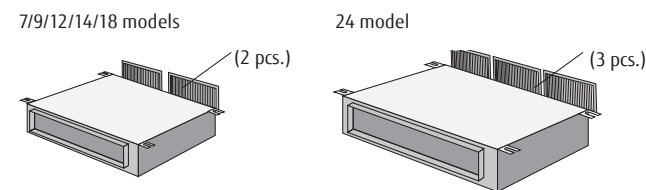

Flexible installation

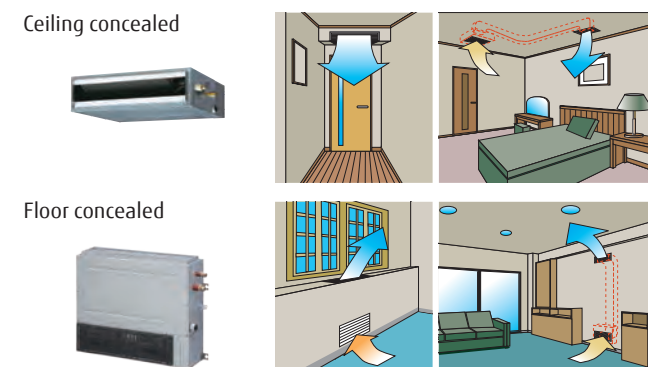

Auto Louver Grille Kit (Option)

Simple flat Auto Louver will provide comfort airflow and harmonize with luxury interior.

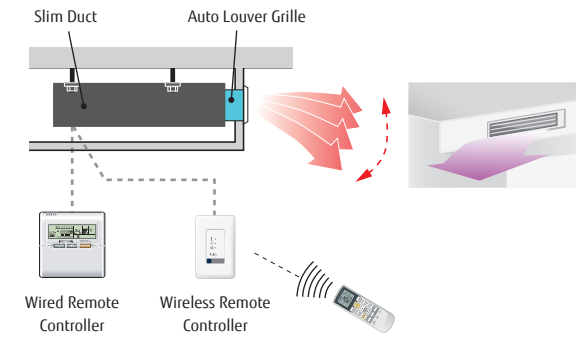

Optional parts

- Remote Sensor Unit : UTY-XSZXZ1
- IR Receiver Unit : UTB-YWC (For ARXD**GATH)
 UTY-TRHX (For ARXD***GLEH)
- Auto Louver Grille Kit: UTD-GXTA-W (for 7/9/12/14 models)
 UTD-GXTB-W (for 18 model)
 UTD-GXTC-W (for 24 model)
- External Power Supply Unit : UTZ-GXXC (ARXD***GLEH)

Specifications

Model name	ARXD007GLEH ARXD07GATH	ARXD009GLEH ARXD09GATH	ARXD012GLEH ARXD12GATH	ARXD014GLEH ARXD14GATH	ARXD018GLEH ARXD18GATH	ARXD024GLEH ARXD24GATH	
Power source	Single phase, ~230V,						
Capacity	Cooling	2.2	2.8	3.6	4.5	5.6	7.1
	Heating	2.8	3.2	4.0	5.0	6.3	8.0
Input power		44	50	54	92	83	122
Airflow rate	High	550	600	600	800	940	1,330
	Med-High*1	520	510	530	680	820	1,140
	Med	480	460	490	600	730	1,020
	Med-Low*1	410	420	450	520	630	900
	Low	370	370	410	440	540	780
Quiet*1	320	320	340	340	470	610	
Static pressure range	0 to 90	0 to 90	0 to 90	0 to 90	0 to 90	0 to 50	
Standard static pressure		25	25	25	25	25	
	High	28	29	30	34	34	35
	Med-High*1	26	27	28	32	31	31
	Med	25	25	27	30	29	29
	Med-Low*1	24	24	26	28	27	27
Low	22	22	24	25	25	24	
Quiet*1	21	21	22	22	23	21	
Dimensions (H x W x D)	mm	198 x 700 x 620	198 x 700 x 620	198 x 700 x 620	198 x 700 x 620	198 x 900 x 620	198 x 1,100 x 620
Weight	kg	17	17	18	18	22	26
Connection pipe diameter	Liquid (Flare)	6.35	6.35	6.35	6.35	6.35 / 9.52*2	9.52
	Gas (Flare)	9.52/12.70*2	9.52/12.70*2	12.70	12.70	12.70 / 15.88*2	15.88
Drain hose diameter (I.D./O.D.)							25 / 32

Note : Specifications are based on the following conditions.
 Cooling : Indoor temperature of 27°CDB / 19°CWB, and outdoor temperature of 35°CDB / 24°CWB.
 Heating : Indoor temperature of 20°CDB / (15°CWB), and outdoor temperature of 7°CDB / 6°CWB.
 Pipe length : 7.5 m; Height difference between outdoor unit and indoor unit : 0 m.

*1: ARXD***GLEH only
 *2: GLEH / GATH

Dimensions (Unit: mm)

*Service accessibility must be allowed for when installing the product. Please consult the installation manual for the necessary service access size.

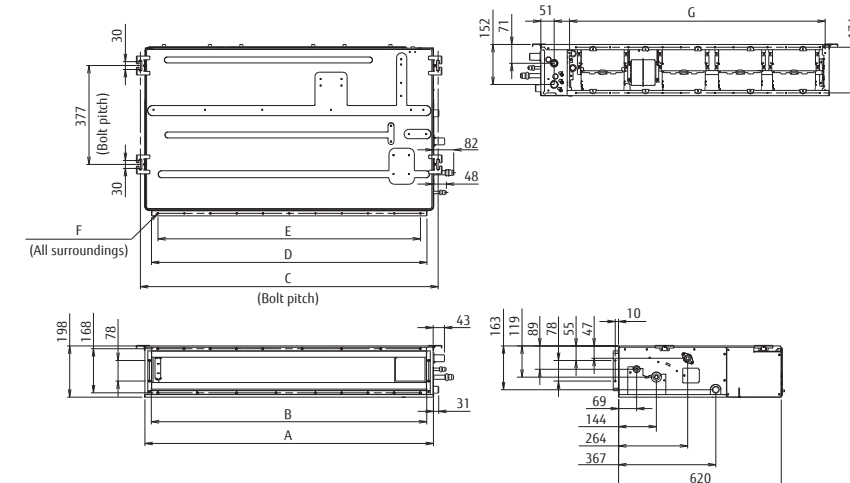

	ARXD07-14	ARXD18	ARXD24
A	700	900	1,100
B	650	850	1,050
C	734	934	1,134
D	650	850	1,050
E	P100x6=600	P100x8=800	P100x10=1,000
F	18xØ5	22xØ5	26xØ5
G	574	774	974

Low / Medium Static Pressure Duct

- Models (Low Static Pressure Duct)**
 ARXB24GALH / ARXB30GALH
 ARXB36GALH / ARXB45GALH
- Models (Medium Static Pressure Duct)**
 ARXA024GLEH / ARXA030GLEH
 ARXA036GLEH / ARXA045GLEH
 ARXA24GBTH / ARXA30GBTH
 ARXA36GBTH / ARXA45GBTH



Feature

Slim & Compact design

The slim and compact design of the indoor unit, with the control box mounted on the side of the unit, allows installation in narrow spaces.

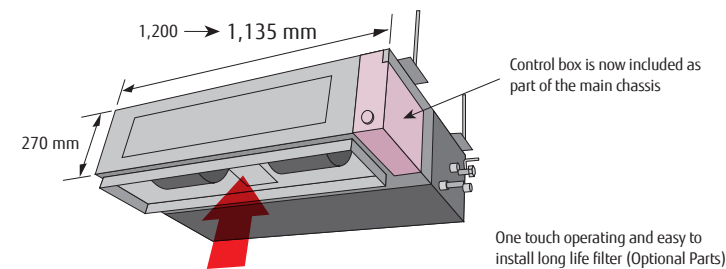

Low energy consumption by high efficiency DC fan motor

Improved motor efficiency from previous model.

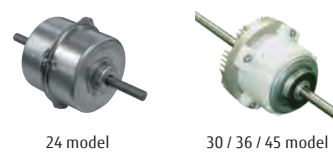

Can be installed for various location

It can be installed in such locations as high-rise condominiums by low static pressure design.



It can also be installed in wide spade when high static pressure is required, such as for offices.

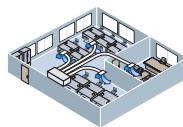

Selectable with a wide range of static pressure

It is possible to change of static pressure range 0 to 150 Pa.

Static pressure range
0 to 150 Pa

Easy maintenance

See below for the case of rear suction type

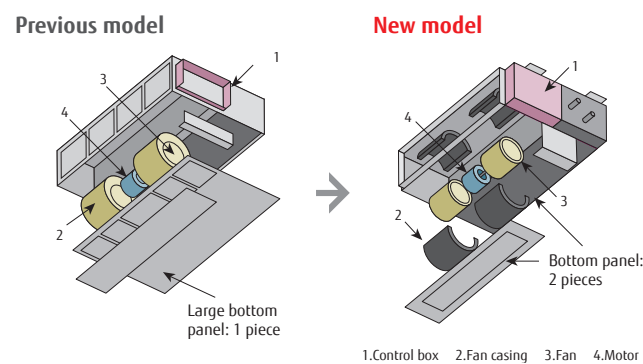

Structural improvement is attained by making the bottom panel two pieces, front and rear. The internal fan casing is also manufactured in two pieces, namely upper and lower. The maintenance of the motor and fan can be easily carried out by removing the rear panel and the lower part of the casing while leaving the main chassis installed.

Easy setting by using remote controller

The change of static pressure range is possible by remote controller



Two-direction drain piping

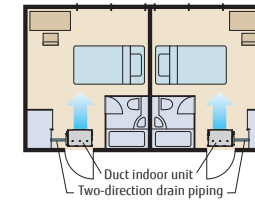

Installation styles

Embedded in Ceiling

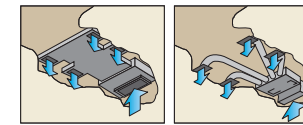

Hanging from Ceiling

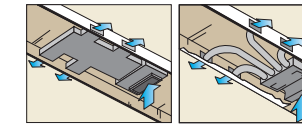

Optional parts

- Remote Sensor Unit : UTY-XSZXZ1
 Long Life Filter : UTD-LF25NA (For ARXA**GLEH, ARXB**GBTH)
 Flange (Square) : UTD-SF045T (For ARXA**GLEH, ARXB**GBTH)
 Flange (Round) : UTD-RF204 (For ARXA**GLEH, ARXB**GBTH)
 IR Receiver Unit : UTB-YWC (For ARXB**GALH, ARXA**GBTH)
 UTY-TRHX (For ARXA**GLEH)
 UTZ-PX1NBA
 Drain Pump Unit : UTZ-PX1NBA
 External Power Supply Unit: UTZ-GXXC (ARXA**GLEH)

Specifications

Model name	ARXB24GALH	ARXB30GALH	ARXB36GALH	ARXB45GALH	ARXA024GLEH ARXA24GBTH	ARXA030GLEH ARXA30GBTH	ARXA036GLEH ARXA36GBTH	ARXA045GLEH ARXA45GBTH	
Power source	Single phase, ~230V, 50Hz								
Capacity	Cooling	7.1	9.0	11.2	12.5	7.1	9.0	11.2	12.5
	Heating	8.0	10.0	12.5	14.0	8.0	10.0	12.5	14.0
Input power	W	145	198	253	338	94	108	194	240
Airflow rate	High	1,100	1,410	1,710	1,970	1,280	1,410	1,840	1,970
	Med-High*1	-	-	-	-	1,180	1,350	1,750	1,910
	Med	920	1,280	1,600	1,790	1,090	1,280	1,660	1,860
	Med-Low*1	-	-	-	-	1,000	1,240	1,600	1,780
	Low	810	1,150	1,470	1,670	920	1,190	1,530	1,710
Quiet*1	-	-	-	-	840	1,150	1,470	1,640	
Static pressure range	Pa	0 to 80	0 to 80	0 to 80	0 to 80	0 to 150	0 to 150	0 to 150	0 to 150
Standard static pressure	High	31	34	37	41	31	34	37	41
	Med-High*1	-	-	-	-	29	33	36	40
	Med	27	32	35	38	27	32	35	38
	Med-Low*1	-	-	-	-	26	31	35	38
	Low	25	29	33	36	24	30	34	37
Quiet*1	-	-	-	-	23	29	33	36	
Dimensions (H x W x D)	mm	270 x 1,135 x 700	270 x 1,135 x 700	270 x 1,135 x 700	270 x 1,135 x 700	270 x 1,135 x 700	270 x 1,135 x 700	270 x 1,135 x 700	270 x 1,135 x 700
Weight	kg	39	42	42	42	36	40	40	40
Connection pipe diameter	Liquid (Flare)	9.52	9.52	9.52	9.52	9.52	9.52	9.52	9.52
	Gas (Flare)	15.88	15.88	19.05	19.05	15.88	15.88	15.88 / 19.05*2	15.88 / 19.05*2
Drain hose diameter (I.D./O.D.)									25 / 32

Note : Specifications are based on the following conditions.
 Cooling : Indoor temperature of 27°CDB / 19°CWB, and outdoor temperature of 35°CDB / 24°CWB.
 Heating : Indoor temperature of 20°CDB / (15°CWB), and outdoor temperature of 7°CDB / 6°CWB.
 Pipe length : 7.5 m; Height difference between outdoor unit and indoor unit : 0 m.

*1: ARXA**GLEH only
 *2: GLEH / GBTH

Dimensions (Unit: mm)

*Service accessibility must be allowed for when installing the product. Please consult the installation manual for the necessary service access size.

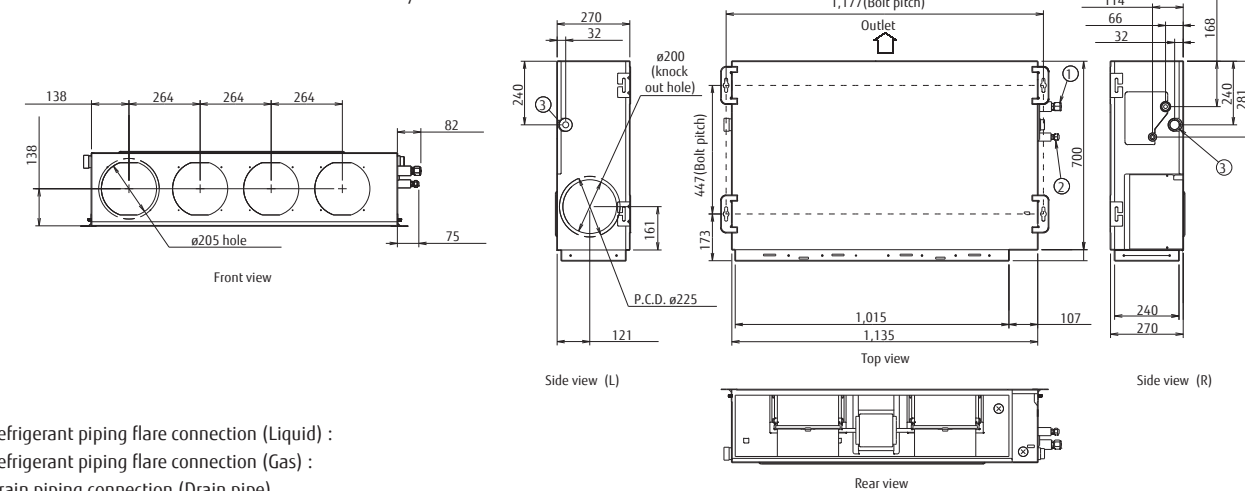

- ① Refrigerant piping flare connection (Liquid) :
- ② Refrigerant piping flare connection (Gas) :
- ③ Drain piping connection (Drain pipe)

High Static Pressure Duct

Models

ARXC036GTEH / ARXC045GTEH / ARXC060GTEH

Models

ARXC072GTEH / ARXC090GTEH

Models

ARXC096GTEH



Features

Static pressure selection

By using DC fan motor, it is possible to change the static pressure range from 0 to 200Pa (036GTEH) / 250Pa (045 / 060GTEH) / 300Pa (072 / 090 / 096GTEH).

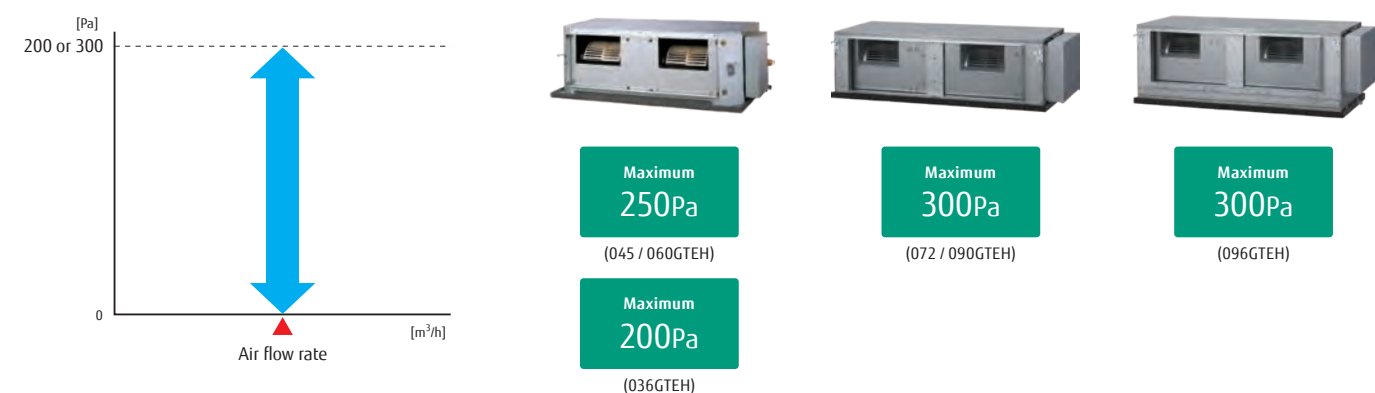

Low noise

036 / 045 / 060 models

Cutting off the corners of the conventional indoor unit front panel and fan casing, has enabled less turbulent air flow. Low noise is realized by adopting a plastic case and a plastic fan.

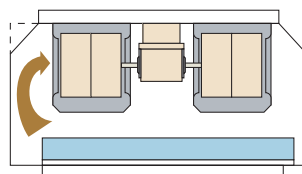

036 model : Plastic fan [42dB(A)]

* Model : Material (At 100 Pa : Actual noise measurement value)

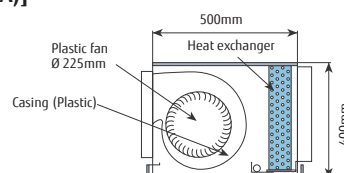

Low energy consumption by high efficiency DC fan motor

Improved motor efficiency from previous model.



Easy installation (Compact size & Lightweight)

A compact size and lightweight indoor unit has been developed by reducing the basic chassis and the overall material weight.

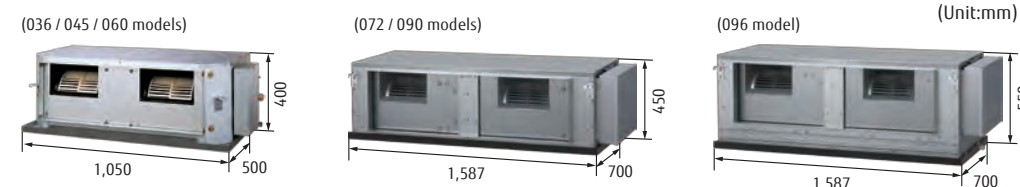

Optional parts

- Long-Life Filter : UTD-LF60KA (For 036 / 045 / 060 models)
- IR Receiver Unit : UTY-TRHX
- Remote Sensor Unit : UTY-XSZXZ1
- External Power Supply Unit: UTZ-GXXC

Specifications

Model name	ARXC036GTEH	ARXC045GTEH	ARXC060GTEH*	ARXC072GTEH*	ARXC090GTEH*	ARXC096GTEH*
Power source	Single phase, ~230V, 50Hz					
Capacity	Cooling	11.2	12.5	18.0	22.4	28.0
	Heating	12.5	14.0	20.0	25.0	31.5
Input power	207	715	730	681	819	838
Airflow rate	High	1,990	3,500	3,500	3,900	4,850
	Med	1,680	3,000	3,000	3,300	4,000
	Low	1,330	2,460	2,460	3,000	3,600
Static pressure range	0 to 200	100 to 250	100 to 250	0 to 300	0 to 300	0 to 300
Standard static pressure	100	100	100	150	150	150
Sound pressure level	High	42	49	49	47	48
	Med	36	45	45	43	46
	Low	32	42	42	40	44
Dimensions (H x W x D)	400 x 1,050 x 500	400 x 1,050 x 500	400 x 1,050 x 500	450 x 1,587 x 700	450 x 1,587 x 700	550 x 1,587 x 700
Weight	40	46 (101)	46 (101)	84	84	105
Connection pipe diameter	Liquid	9.52 (Flare)	9.52 (Flare)	9.52 (Flare)	9.52 (Flare)	9.52 (Flare)
	Gas	15.88 (Flare)	15.88 (Flare)	15.88 (Flare)	19.05 (Flare)	19.05 (Flare)
Drain hose diameter (I.D./O.D.)	25 / 32					

Note : Specifications are based on the following conditions.
 Cooling : Indoor temperature of 27°CDB / 19°CWB, and outdoor temperature of 35°CDB / 24°CWB.
 Heating : Indoor temperature of 20°CDB / (15°CWB), and outdoor temperature of 7°CDB / 6°CWB.
 Pipe length : 7.5 m; Height difference between outdoor unit and indoor unit : 0 m.

* 060 / 072 / 090 / 096 models cannot be connected to J-III / J-IIS Series.

Dimensions (Unit: mm)

Models: ARXC036, ARXC045, ARXC060

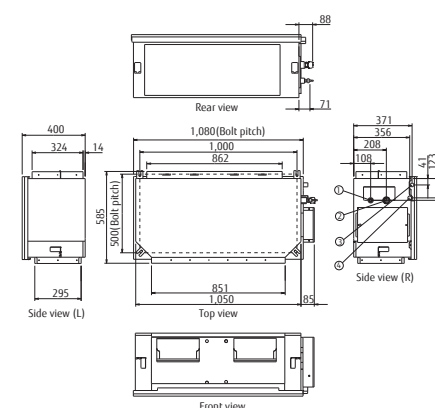

Models: ARXC072, ARXC090

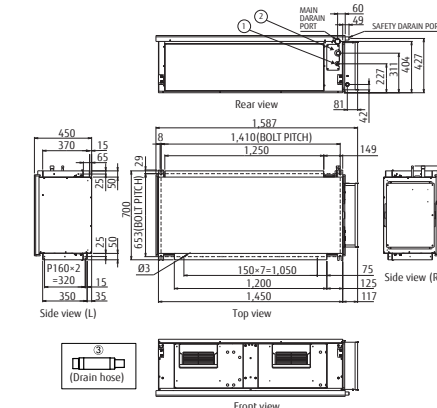

Models: ARXC096

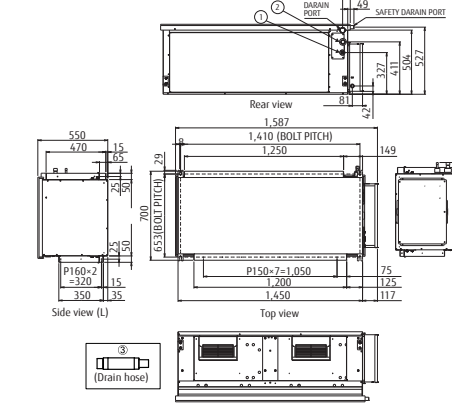

- ① Refrigerant piping flare connection (Liquid)
- ② Refrigerant piping flare connection (Gas)
- ③ Drain piping connection

- ① Refrigerant pipe flare connection (Liquid)
- ② Refrigerant pipe flare connection (Gas)
- ③ Drain hose

- ① Refrigerant pipe flare connection (Liquid)
- ② Refrigerant pipe flare connection (Gas)
- ③ Drain hose

Floor (Compact)

Models (EEV internal)
 AGHA007GCGH / AGHA009GCGH
 AGHA012GCGH / AGHA014GCGH



Feature

2-Fan & Wide airflow

Individual vertical airflow by 2-fan can control the whole room comfortably.

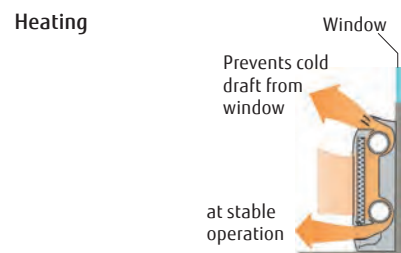
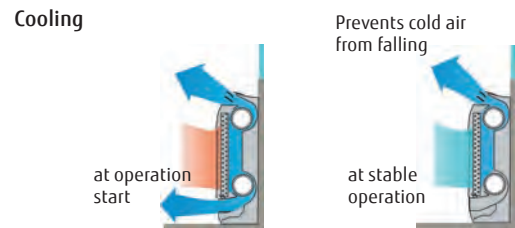

Flexible & easy installation

Due to compact and whole surface suction method model, floor, concealed, half concealed, or wall mounted installation can be available to match the room layout.

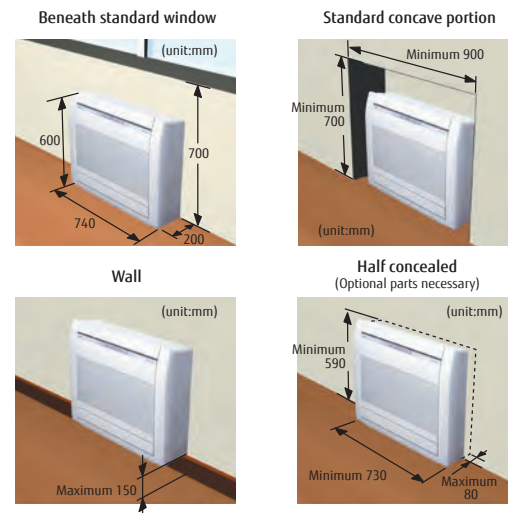

Specifications

Model name	AGHA007GCGH		AGHA009GCGH		AGHA012GCGH		AGHA014GCGH	
Power source	Single phase, ~230V, 50Hz							
Capacity	Cooling	kW	2.2	2.8	3.6	4.0	4.5	4.0
	Heating	kW	2.8	3.2	4.0	4.5	4.5	4.0
Input power		W	16	17	22	29	29	22
Airflow rate	High	m ³ /h	470	500	590	670	670	500
	Med-High		420	450	520	590	590	450
	Med		390	400	470	520	520	400
	Med-Low		360	360	420	450	450	360
	Low		330	330	390	420	420	330
Sound pressure level	High	dB (A)	270	270	340	340	340	270
	Med-High		37	38	42	46	46	37
	Med		35	36	39	42	42	35
	Med-Low		33	34	37	39	39	33
	Low		29	29	33	33	33	29
Quiet	22	22	30	30	30	22		
Dimensions (H × W × D)	mm		600 × 740 × 200	600 × 740 × 200	600 × 740 × 200	600 × 740 × 200	600 × 740 × 200	600 × 740 × 200
Weight	kg		15	15	15	15	15	15
Connection pipe diameter	Liquid (Flare)	mm	6.35	6.35	6.35	6.35	6.35	6.35
	Gas (Flare)		9.52	9.52	12.70	12.70	12.70	12.70
Drain hose diameter (I.D./O.D.)	13.8 / 15.8 to 16.7							

Note : Specifications are based on the following conditions.
 Cooling : Indoor temperature of 27°CDB / 19°CWB, and outdoor temperature of 35°CDB / 24°CWB.
 Heating : Indoor temperature of 20°CDB / (15°CWB), and outdoor temperature of 7°CDB / 6°CWB.
 Pipe length : 7.5 m; Height difference between outdoor unit and indoor unit : 0 m. Voltage : 230 [V].
 When AGHA007GCGH and AGHA009GCGH are connected to the outdoor unit other than J-III, gas pipe diameter should be Ø12.70.

Dimensions (Unit: mm)

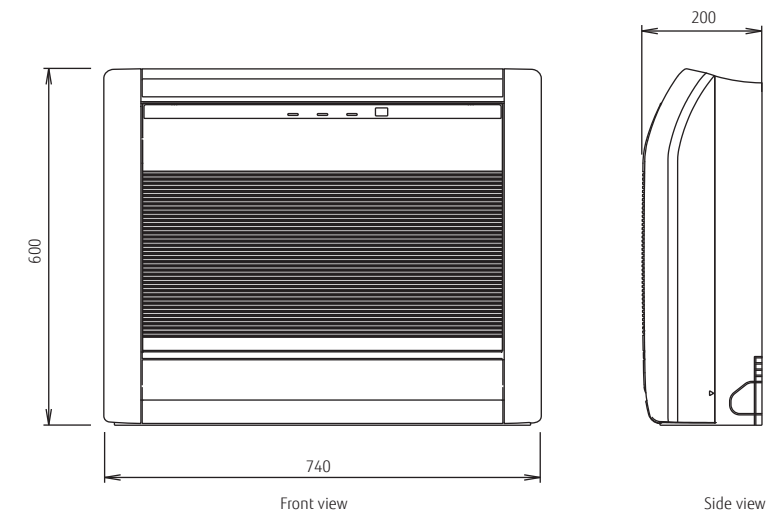

Quiet operation

Quiet operation is realized by 6 fan speed control. (via 2 wire controller)

Low noise
22 dB(A)
 at 7/9 models



* Compatible Remote Controller is as follows:
 UTY-RNRG25 / UTY-RLRG / UTY-RSRG / UTY-RHRG / UTY-DCGG22 / UTY-DTGG21 / UTY-ALGX21 / UTY-APGX21

Flexible piping connection 6 direction of drain & piping

Drain hose and piping can be drawn flexibly in the right, left, side, and down directions

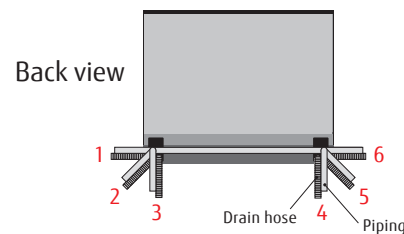

Optional parts

Half concealed kit: UTR-STA
 External Power Supply Unit: UTZ-GXXC

Floor / Ceiling

Models

ABHA012GTEH / ABHA014GTEH
ABHA018GTEH / ABHA024GTEH



Floor standing



Feature

Flexible installation

Example for floor installation

Floor console



Example for ceiling installation

Under ceiling



Double auto swing

A combination of up/down and right/left directional swing allows three-dimensional air direction control.

RIGHT and LEFT SWING

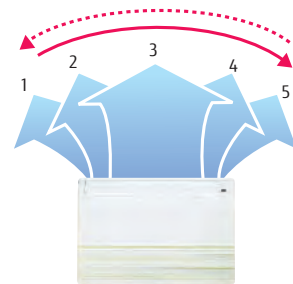

UP and DOWN SWING

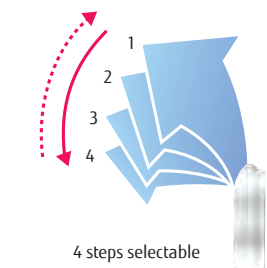

4 steps selectable

High power DC fan motor

- High power
- Wide rotation range
- High efficiency



Compact design

Symmetrical, slim and compact design.

(Unit:mm)

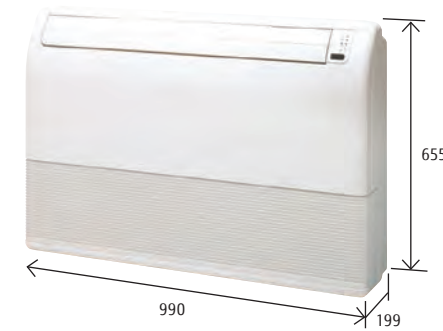

Auto-closing louver

When operation is stopped, the louvers will automatically close. (This function is available on all non-ducted models.)

Super vane

Double Louver Super vane with newly developed special configuration boosts airflow sending cool air quickly to every corner of the room.

Optional parts

External Power Supply Unit : UTZ-GXXC

Specifications

Model name			ABHA012GTEH	ABHA014GTEH	ABHA018GTEH	ABHA024GTEH
Power source			Single phase, ~230V, 50Hz			
Capacity	Cooling	kW	3.6	4.5	5.6	7.1
	Heating		4.0	5.0	6.3	8.0
Input power		W	30	42	74	99
Airflow rate	High	m ³ /h	660	780	1,000	1,000
	Med-High		620	740	910	930
	Med		580	690	830	870
	Med-Low		550	640	750	800
	Low		520	600	660	740
	Quiet		490	550	580	680
Sound pressure level	High	dB (A)	36	40	46	47
	Med-High		34	39	44	45
	Med		33	38	42	43
	Med-Low		31	36	40	41
	Low		29	35	37	39
	Quiet		28	34	35	37
Dimensions (H × W × D)	mm		199 × 990 × 655	199 × 990 × 655	199 × 990 × 655	199 × 990 × 655
Weight	kg		25	26	26	27
Connection pipe diameter	Liquid (Flare)	mm	6.35	6.35	6.35	9.52
	Gas (Flare)	mm	12.70	12.70	12.70	15.88
Drain hose diameter (I.D./O.D.)			25 / 32			

Note : Specifications are based on the following conditions.

Cooling : Indoor temperature of 27°CDB / 19°CWB, and outdoor temperature of 35°CDB / 24°CWB.

Heating : Indoor temperature of 20°CDB / (15°CWB), and outdoor temperature of 7°CDB / 6°CWB.

Pipe length : 7.5 m; Height difference between outdoor unit and indoor unit : 0 m. Voltage : 230 [V].

Dimensions (Unit: mm)

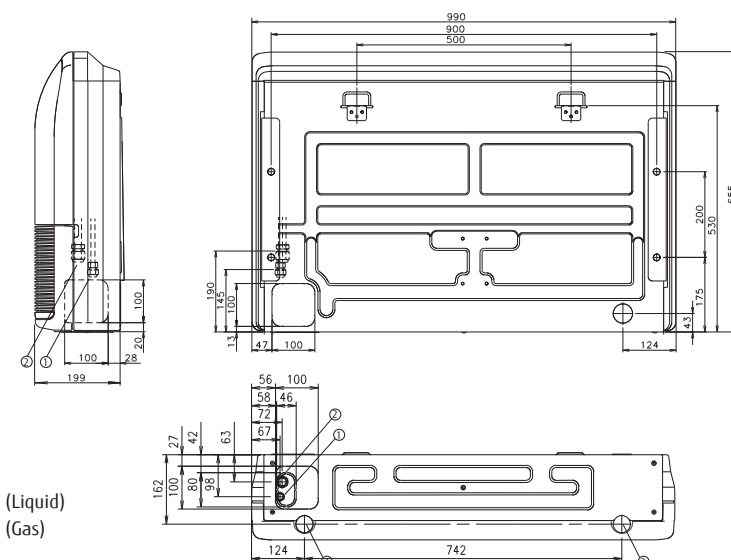

- ① Refrigerant piping flare connection (Liquid)
- ② Refrigerant piping flare connection (Gas)
- ③ Drain piping connection

Ceiling

Models
 ABHA030GTEH / ABHA036GTEH
 ABHA045GTEH / ABHA054GTEH



Feature

Installation

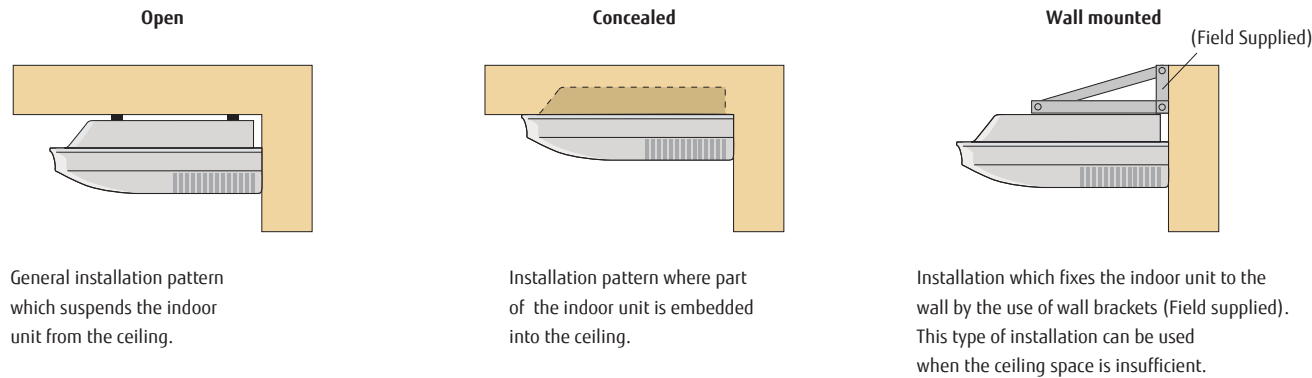

General installation pattern which suspends the indoor unit from the ceiling.

Installation pattern where part of the indoor unit is embedded into the ceiling.

Installation which fixes the indoor unit to the wall by the use of wall brackets (Field supplied). This type of installation can be used when the ceiling space is insufficient.

Double auto swing and wide airflow

Auto airflow direction and auto swing

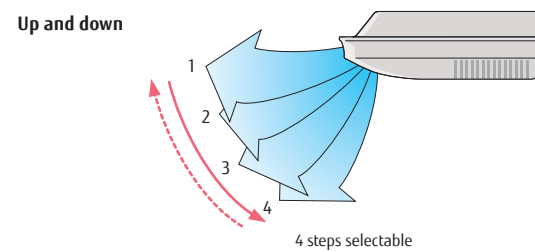
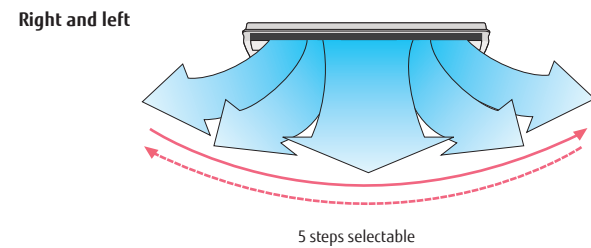

Long airflow

Long Airflow ensures comfort to every corner of a large room.

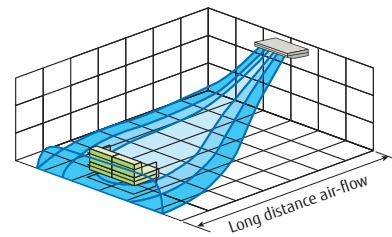

High power DC fan motor

- High power
- Wide rotation range
- High efficiency



Fresh air intake

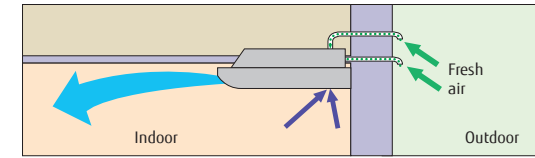

Slim & Compact design



High lift drain pump

Optional drain pump unit allows flexible installation design.

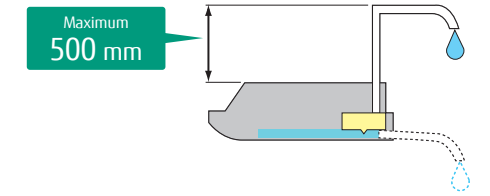

Optional parts

- Drain Pump Unit : UTR-DPB24T
- Flange : UTD-RF204
- External Power Supply Unit : UTZ-GXXC

Specifications

Model name		ABHA030GTEH	ABHA036GTEH	ABHA045GTEH	ABHA054GTEH
Power source		Single phase, ~230V, 50Hz			
Capacity	Cooling	9.0	11.2	12.5	14.0
	Heating	10.0	12.5	14.0	16.0
Input power	W	66	85	131	180
Airflow rate	High	1,630	1,690	2,010	2,270
	Med-High	1,520	1,560	1,840	2,070
	Med	1,420	1,450	1,690	1,860
	Med-Low	1,320	1,360	1,530	1,660
	Low	1,220	1,270	1,380	1,470
Sound pressure level	Quiet	1,140	1,170	1,230	1,280
	High	42	45	48	51
	Med-High	40	41	46	49
	Med	39	39	45	46
	Med-Low	37	38	41	43
Dimensions (H x W x D)	mm	240 x 1,660 x 700	240 x 1,660 x 700	240 x 1,660 x 700	240 x 1,660 x 700
	kg	46	48	48	48
Connection pipe diameter	Liquid (Flare)	9.52	9.52	9.52	9.52
	Gas (Flare)	15.88	15.88	15.88	15.88
Drain hose diameter (I.D./O.D.)		25 / 32			

Note : Specifications are based on the following conditions.
 Cooling : Indoor temperature of 27°CDB / 19°CWB, and outdoor temperature of 35°CDB / 24°CWB.
 Heating : Indoor temperature of 20°CDB / (15°CWB), and outdoor temperature of 7°CDB / 6°CWB.
 Pipe length : 7.5 m; Height difference between outdoor unit and indoor unit : 0 m. Voltage : 230 [V].

Dimensions (Unit: mm)

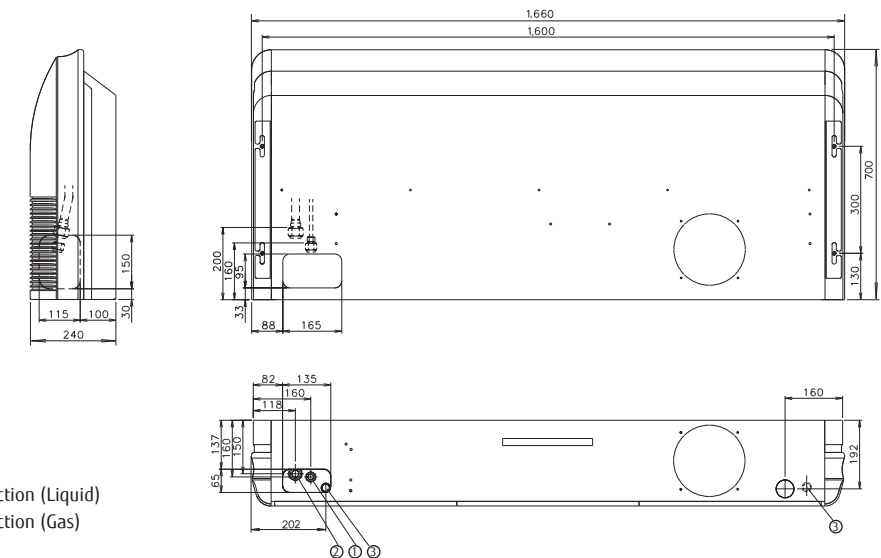

- ① Refrigerant piping flare connection (Liquid)
- ② Refrigerant piping flare connection (Gas)
- ③ Drain piping connection

Wall Mounted

Models (EEV internal)
 ASHA07GATH / ASHA09GATH
 ASHA12GATH / ASHA14GATH



High power DC fan motor

- High power
- Wide rotation range
- High efficiency
- Compact size



Easy maintenance

Easy maintenance has been realized as the front panel can be removed for easy access.

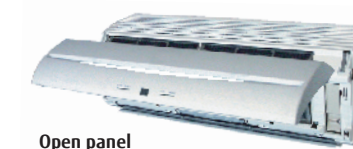

Open panel

Symmetrical design

Symmetrical, clean design that suits all interiors.



Feature

Filter features

High performance filter provides high quality air conditioning

Long-life* Ion Deodorization Filter

The filter deodorizes by powerfully decomposing absorbed odors using the oxidizing and reducing effects of ions generated by the ultra-fine-particle ceramic.

(*The filter can be used for approx. 3 years if it is washed under water to restore its surface action when it is dirty.)

Apple-catechin Filter

Fine dust, invisible mold spores, and harmful microorganisms are absorbed onto the filter by static electricity, and further growth is inhibited and deactivated by the polyphenol extracted from apples.

Deodorizing effect (Odor reduction rate)

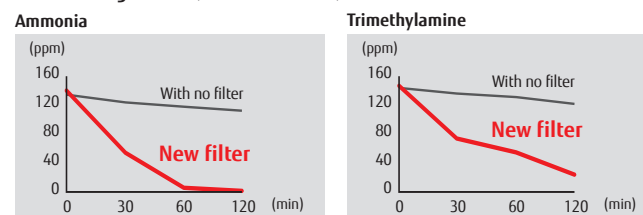

Hydrogen sulfate



High performance filters have been thoroughly tested by the Environmental Sanitary Inspection Center using an advanced Deodorization Test.

Auto swing louver

The Auto Swing Louver function ensures that the air direction corresponds to the mode selected.

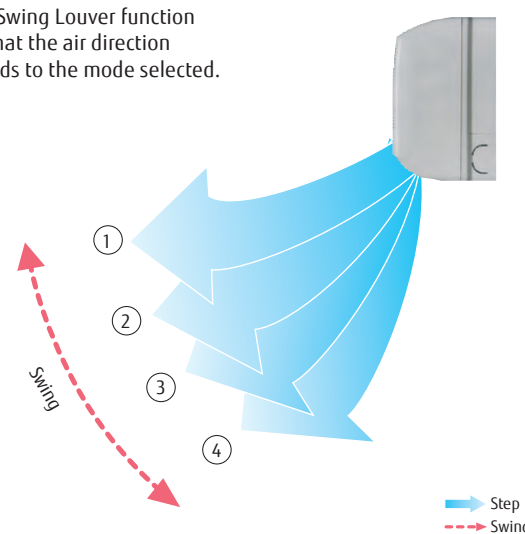

Compact size

Powerful output even compact design

Though the indoor unit is compact, it features a large, high pressure cross fan (90 mm diameter) in a centre mounted configuration and a Lambda type heat exchanger to provide plenty of power.

Width
790 mm



Specifications

Model name			ASHA07GATH	ASHA09GATH	ASHA12GATH	ASHA14GATH
Power source			Single phase, ~230V, 50Hz			
Capacity	Cooling	kW	2.2	2.8	3.6	4.5
	Heating		2.8	3.2	4.1	5.0
Input power	W		17	18	22	34
Airflow rate	High	m ³ /h	490	500	560	670
	Med		450	450	480	490
	Low		370/420*	370/420*	420	420
Sound pressure level	High	dB (A)	35	36	39	44
	Med		33	33	35	37
	Low		27/31*	27/31*	31	32
Dimensions (H × W × D)	mm		275 × 790 × 215	275 × 790 × 215	275 × 790 × 215	275 × 790 × 215
Weight	kg		9	9	9	9
Connection pipe diameter	Liquid (Flare)	mm	6.35	6.35	6.35	6.35
	Gas (Flare)		12.70	12.70	12.70	12.70
Drain hose diameter (I.D./O.D.)			13.8 / 15.8 to 16.7			

Note : Specifications are based on the following conditions.

Cooling : Indoor temperature of 27°CDB / 19°CWB, and outdoor temperature of 35°CDB / 24°CWB.

Heating : Indoor temperature of 20°CDB / (15°CWB), and outdoor temperature of 7°CDB / 6°CWB.

Pipe length : 7.5 m; Height difference between outdoor unit and indoor unit : 0 m. Voltage : 230 [V].

*: This value is under cooling operation.

Dimensions (Unit: mm)

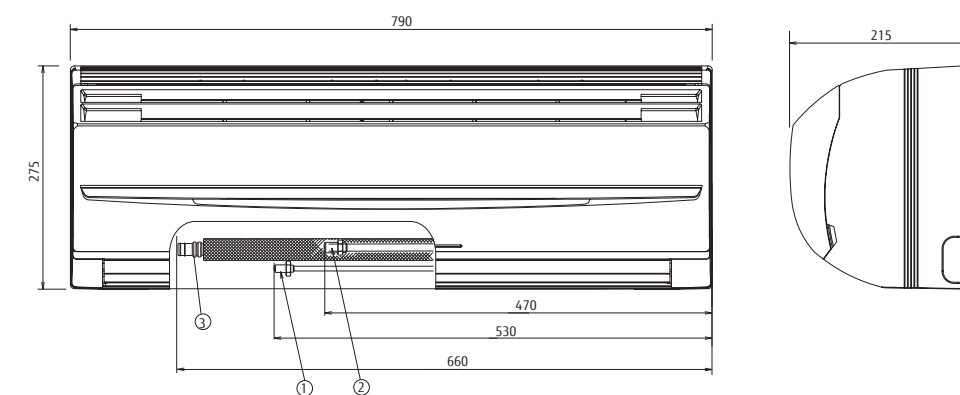

① Refrigerant piping flare connection (Liquid)

② Refrigerant piping flare connection (Gas)

③ Drain piping connection

Wall Mounted

Models (EEV internal)
ASHA007GTEH / ASHA009GTEH



Feature

High efficient compact design

Ø5mm high density heat exchanger is mounted for the first time in the industry.

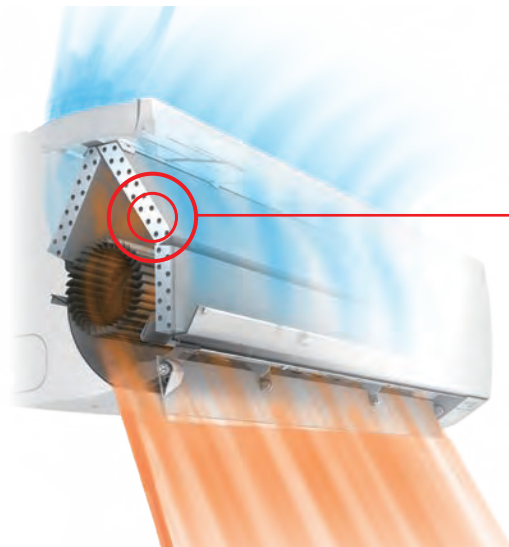

High density heat exchanger

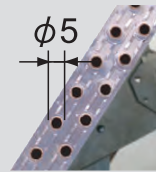

Making the tube thin:
7mm → 5mm

Increase of heat exchanger volume
by high density and adopting sub
heat exchanger



Specifications

Model name		ASHA007GTEH		ASHA009GTEH	
Power source		Single - phase, ~230V,			
Capacity	Cooling	2.2		2.8	
	Heating	2.8		3.2	
Input power		19		34	
Airflow rate	High	550		720	
	Med-H	460		570	
	Med	420		500	
	Med-L	390		410	
	Low	360		360	
	Quiet	330		330	
Sound pressure level	High	35		43	
	Med-H	32		38	
	Med	30		34	
	Med-L	27		29	
	Low	24		24	
	Quiet	22		22	
Dimensions (H × W × D)		mm 262×820×206		262×820×206	
Weight		kg 7.5		7.5	
Connection pipe diameter	Liquid (Flare)	6.35		6.35	
	Gas (Flare)	9.52		9.52	
Drain hose diameter (I.D./O.D.)		13.8 / 15.8 to 16.7			

Note : Specifications are based on the following conditions.

Cooling : Indoor temperature of 27°CDB / 19°CWB, and outdoor temperature of 35°CDB / 24°CWB.
Heating : Indoor temperature of 20°CDB / (15°CWB), and outdoor temperature of 7°CDB / 6°CWB.
Pipe length : 7.5 m; Height difference between outdoor unit and indoor unit : 0 m. Voltage : 230 [V].

When ASHA007GTEH, ASHA009GTEH are connected to the outdoor unit other than J-III, gas pipe diameter should be Ø12.70.

6 Fan Speed Control

Multistep airflow control is possible to suit the environment.

Fan speed	Low noise
Quiet	22 dB(A)

6-Step Speed

- High
- Med-H
- Med
- Med-L
- Low
- Quiet



Easy installation

Communication wiring can be installed easily by only opening the front panel and wire cover.

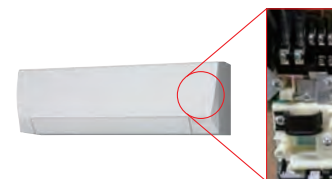

Optimized design matches to a small room

Efficient operation and refrigerant saving are realized by optimum heat exchanger design suited for small rooms.

Optional parts

External Power Supply Unit: UTZ-GXXC

Dimensions (Unit: mm)

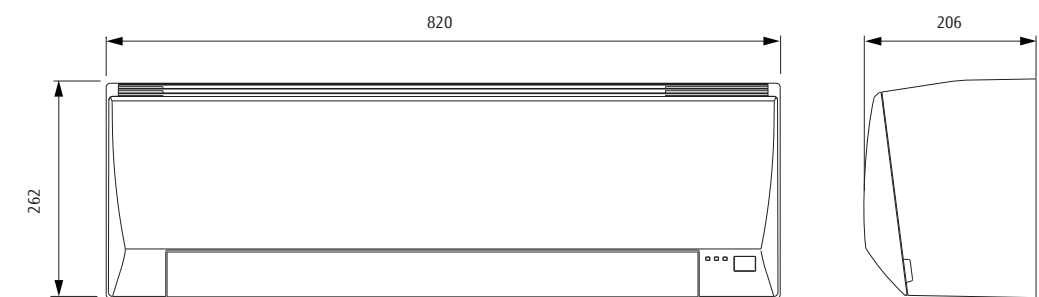

Wall Mounted

Models (EEV internal)
 ASHA007GCGH / ASHA009GCGH
 ASHA012GCGH / ASHA014GCGH



Feature

High efficient and compact design

The 007-014 model has a common design. High efficient compact design is realised by mounting a high density and large heat exchanger. The compact body makes it possible to install discreetly even in a meeting room or office where comfortable air conditioning is provided.

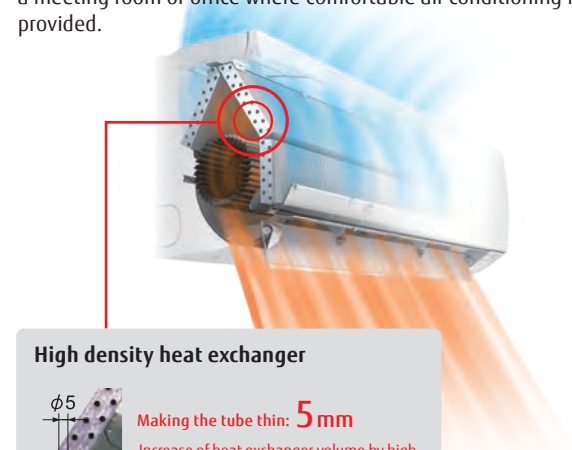

High density heat exchanger

Making the tube thin: **5mm**
 Increase of heat exchanger volume by high density and adopting sub heat exchanger

More comfort airflow

Comfortable air conditioning is provided by mounting our unique power diffuser.

Heating

Vertical airflow provides powerful floor level heating



Cooling

Horizontal airflow does not blow cool air directly at the occupants in the room.



Quiet operation & 6 Fan speed control

Drastic low noise is realized by new airflow structure. In addition, multistep quiet operation is available by 6-step sound level settings.

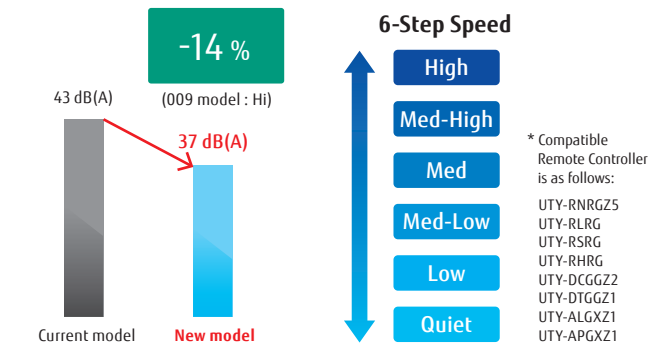

Optional parts

External Power Supply Unit :UTZ-GXXC

Specifications

Model name			ASHA007GCGH	ASHA009GCGH	ASHA012GCGH	ASHA014GCGH
Power source			Single phase, ~230V, 50Hz			
Capacity	Cooling	kW	2.2	2.8	3.6	4.0
	Heating		2.8	3.2	4.0	4.5
Input power		W	16	20	25	36
Airflow rate	High	m ³ /h	550	610	690	800
	Med-High		510	560	610	740
	Med		470	510	560	680
	Med-Low		410	440	530	610
	Low		360	360	470	550
	Quiet		310	310	330	330
Sound pressure level	High	dB (A)	34	37	40	44
	Med-High		32	35	37	42
	Med		30	32	35	40
	Med-Low		28	29	33	37
	Low		26	26	30	34
	Quiet		22	22	24	24
Dimensions (H × W × D)	mm		268 × 840 × 203	268 × 840 × 203	268 × 840 × 203	268 × 840 × 203
Weight	kg		8.5	8.5	8.5	8.5
Connection pipe diameter	Liquid (Flare)		6.35	6.35	6.35	6.35
	Gas (Flare)	mm	9.52	9.52	12.70	12.70
Drain hose diameter (I.D./O.D.)			13.8 / 15.8 to 16.7			

Note : Specifications are based on the following conditions.

Cooling : Indoor temperature of 27°CDB / 19°CWB, and outdoor temperature of 35°CDB / 24°CWB.

Heating : Indoor temperature of 20°CDB / (15°CWB), and outdoor temperature of 7°CDB / 6°CWB.

Pipe length : 7.5 m; Height difference between outdoor unit and indoor unit : 0 m. Voltage : 230 [V].

When ASHA007GCGH and ASHA009GCGH are connected to the outdoor unit other than J-III, gas pipe diameter should be Ø12.70.

Dimensions (Unit: mm)

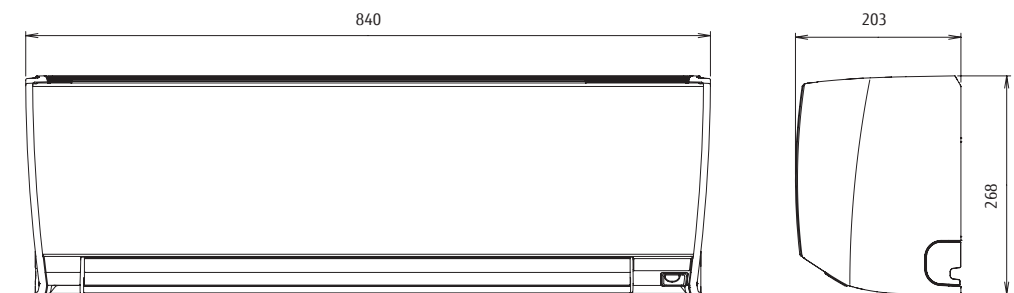

Human sensor increases energy saving operation

Energy saving operation starts automatically by detecting the motion of a person in the space. There are 2 modes available, an energy saving mode or a auto off mode available.

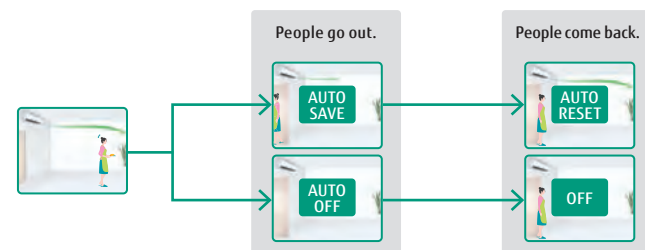

Wall Mounted

Models

ASHA18GACH / ASHA24GACH / ASHA30GACH
ASHA18GATH / ASHA24GATH / ASHA30GATH



Compact & Slim design

By using DC fan motor, compact design is realized.



Easy maintenance

Simplification of drain pan cleaning improves maintenance-ability.



Feature

More comfort airflow by adopting power diffuser

“Vertical airflow” provides powerful floor level heating

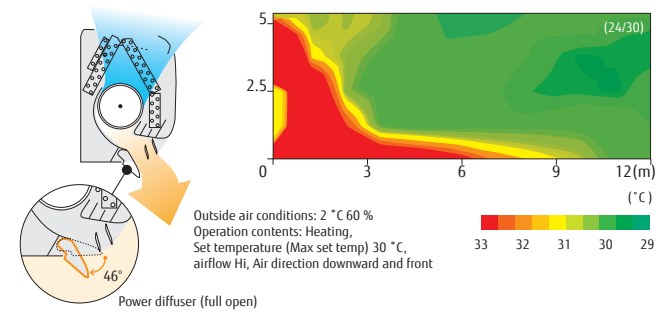

“Horizontal airflow” does not blow cool air directly at the occupants in the room

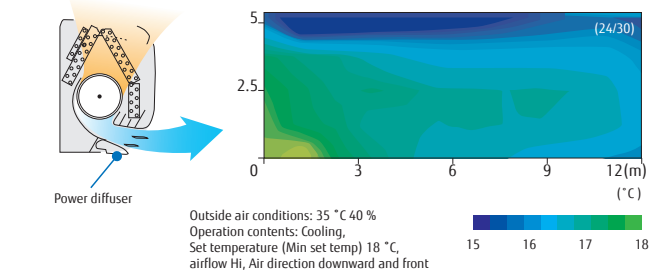

Double auto swing

A combination of up/down and right/left directional swing allows three-dimensional air direction control.

5 steps selectable

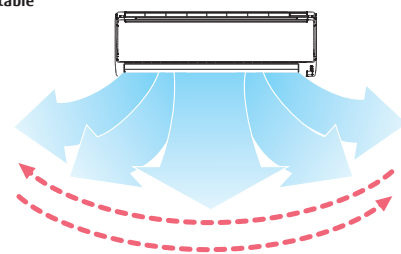

4 steps selectable

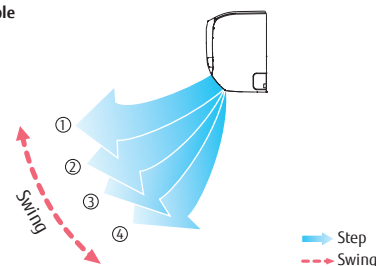

Air conditioner filter features

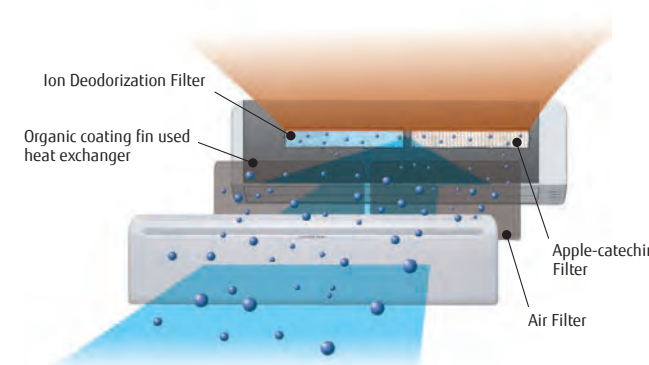

High quality air conditioning by incorporation of high performance filter.

- Ion Deodorization Filter**
The filter deodorizes by powerfully decomposing absorbed odors using the oxidizing and reducing effects of ions generated by the ultra-fine-particle ceramic.
- Apple-catechin Filter**
Apple-catechin filter uses static electricity to clean fine particles and dust in the air.

Specifications

Model name			ASHA18GACH ASHA18GATH	ASHA24GACH ASHA24GATH	ASHA30GACH ASHA30GATH
Power source			Single phase, ~230V, 50Hz		
Capacity	Cooling	kW	5.6	7.1	8.0
	Heating		6.3	8.0	9.0
Input power	W		32	60	91
Airflow rate	High	m ³ /h	840	1,100	1,240
	Med		770	910	980
	Low		690	730	770
Sound pressure level	High	dB (A)	41	48	52
	Med		39	43	45
	Low		35	35	35
Dimensions (H × W × D)	mm		320 × 998 × 228	320 × 998 × 228	320 × 998 × 228
Weight	kg		15	15	15
Connection pipe diameter	Liquid (Flare)		9.52	9.52	9.52
	Gas (Flare)	mm	15.88	15.88	15.88
Drain hose diameter (I.D./O.D.)			12 / 16		

Note : Specifications are based on the following conditions.
Cooling : Indoor temperature of 27 °CDB / 19 °CWB, and outdoor temperature of 35 °CDB / 24 °CWB.
Heating : Indoor temperature of 20 °CDB / (15 °CWB), and outdoor temperature of 7 °CDB / 6 °CWB.
Pipe length : 7.5 m; Height difference between outdoor unit and indoor unit : 0 m. Voltage : 230 [V].

Dimensions (Unit: mm)

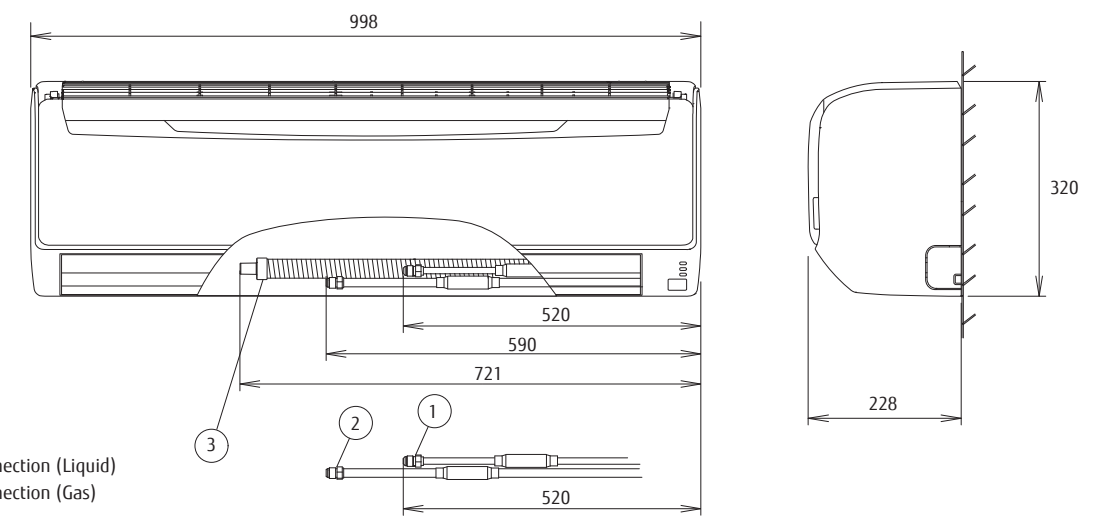

- ① Refrigerant piping flare connection (Liquid)
- ② Refrigerant piping flare connection (Gas)
- ③ Drain piping connection

Wall Mounted

Models

ASHA18GBCH / ASHA24GBCH

Models

ASHA030GTEH / ASHA034GTEH



ASHA18 ASHA24



ASHA030 ASHA034



Feature

Powerful & Comfort airflow

Powerful Airflow

(30 model)

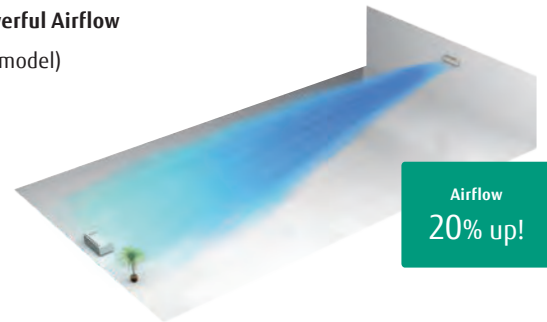

Power diffuser

(18/24 models)

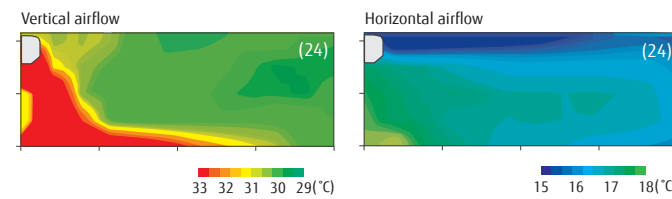

Human sensor (30/34 models only)

A human sensor senses the movement of humans to reduce operation when one is in the room. the wasteful consumption of energy is reduced automatically to keep down electricity bills. (Available to wired remote controller as UTY-RNRGZ5 and UTY-DCGGZ2)

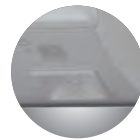

Human sensor



Quiet operation & 6 Fan speed control

Drastic low noise is realized by new airflow structure. In addition, multistep quiet operation is available by 6-step sound level settings.

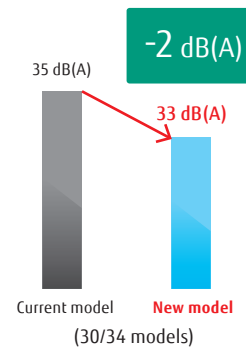

6-Step Speed

- High
- Med-High
- Med
- Med-Low
- Low
- Quiet



* Compatible Remote Controller is as follows:
 UTY-RNRGZ5 / UTY-RLRG / UTY-RSRG / UTY-RHRG / UTY-DCGGZ2 / UTY-DTGGZ1 / UTY-ALGXZ1 / UTY-APGXZ1

Optional parts

External Power Supply Unit: UTZ-GXXC (ASYA***GTEH)
 Silver ion filter II: UTR-FA16-8 (030/034GTEH)



Specifications

Model name			ASHA18GBCH	ASHA24GBCH	ASHA030GTEH	ASHA034GTEH
Power source			Single phase, ~230V, 50Hz			
Capacity	Cooling	kW	5.6	7.1	9.0	10.0
	Heating		6.3	8.0	10.0	11.2
Input power	W		32	60	74	103
Airflow rate	High	m ³ /h	840	1,100	1,440	1,620 / 1,520
	Med-High		-	-	1,200	1,300
	Med		770	910	1,050	1,120
	Med-Low		-	-	940	980
	Low		690	730	890	890
	Quiet		-	-	700	700
Sound pressure level	High	dB (A)	41	48	53	55 / 54
	Med-High		-	-	49	51
	Med		39	43	45	47
	Med-Low		-	-	42	43
	Low		35	35	39	39
	Quiet		-	-	33	33
Dimensions (H × W × D)	mm		320 × 998 × 238	320 × 998 × 238	340 × 1,150 × 280	340 × 1,150 × 280
Weight	kg		15	15	18	18
Connection pipe diameter	Liquid (Flare)	mm	6.35	9.52	9.52	9.52
	Gas (Flare)		12.70	15.88	15.88	15.88
Drain hose diameter (I.D./O.D.)			12 / 16		13.8 / 15.8 to 16.7	

Note : Specifications are based on the following conditions.
 Cooling : Indoor temperature of 27°CDB / 19°CWB, and outdoor temperature of 35°CDB / 24°CWB.
 Heating : Indoor temperature of 20°CDB / (15°CWB), and outdoor temperature of 7°CDB / 6°CWB.
 Pipe length : 7.5 m; Height difference between outdoor unit and indoor unit : 0 m. Voltage : 230 [V].

When ASHA18GBCH is connected to the outdoor unit other than J-IIIIL, pipe diameter should be Ø9.52/Ø15.88 (Liq/Gas).

Dimensions (Unit: mm)

Models: ASHA18 / ASHA24

Models: ASHA030 / ASHA034

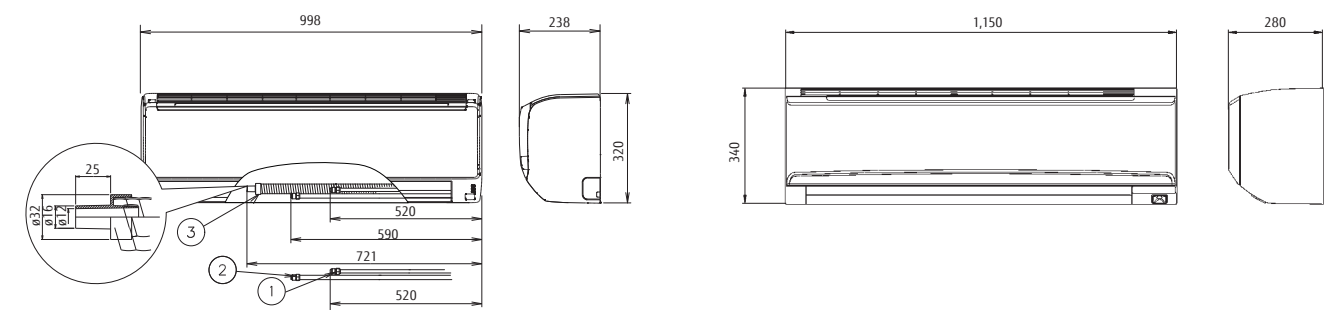

- ① Refrigerant piping flare connection (Liquid)
- ② Refrigerant piping flare connection (Gas)
- ③ Drain piping connection





VENTILATION

EFFECTIVE HEAT EXCHANGE AND SIMULTANEOUS FRESH AIR VENTILATION

High Efficiency and low noise levels are achieved by using a highly efficient heat exchange process. A comfortable air conditioned space is achieved by conveniently selecting whether to use heat exchange or normal ventilation setting, according to the requirements of the conditioned space.

Outdoor-air Processing Unit DX Kit for airhandling applications

Outdoor-air Processing Unit Range

Airflow rate (m ³ /h)	1080	1680	2100
Model code	054	072	096
Outdoor-air Processing Unit	 ARXH054GTAH	 ARXH072GTAH	 ARXH096GTAH

Outdoor-air Processing Unit

Production by order

Models

- ARXH054GTAH
- ARXH072GTAH
- ARXH096GTAH



Feature

One VRF system can provide air conditioning and air supply at the same time.

Outdoor-air Processing Unit can be connected in a same VRF*1 system as one of indoor unit series and can create fresh and comfortable air supply together from our high advanced technology.

*1. Connectable VRF Series: J-1IS

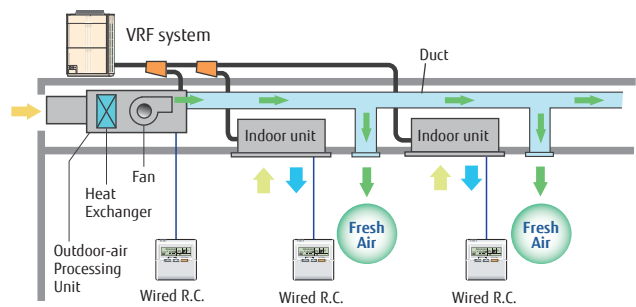
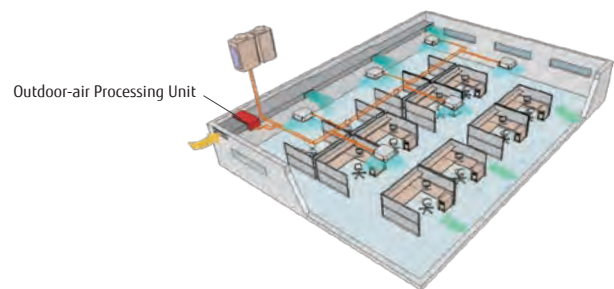

* Make sure the connected capacity is within the range of 50 % to 100 % of the Outdoor-air Processing Unit capacity. In addition, if there are mixed connections with indoor units, make the Outdoor-air Processing Unit connection capacity 30 % or less of the outdoor unit capacity.

High energy savings and flexible duct design by using DC motor

Greatly reduces electricity consumption by adopting permanent magnet compared to when using an AC motor.

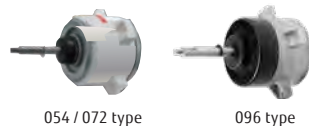

Compared with AC motor, changing the speed makes it possible to respond flexibly to the external static pressure from 50 Pa to 240 Pa. Even if damper equipment is not used, static pressure can be adjusted and duct design is easy.

Static pressure can be set easily using wired remote controller.

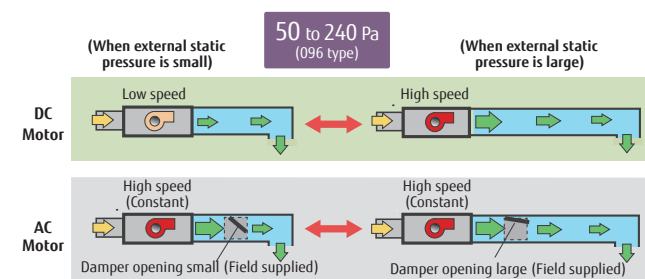

Top class compact design

Top class lightweight compact design at just 425 mm in height, 55 kg in weight for ARXH072 type. This unit can be installed easily even at narrow space.

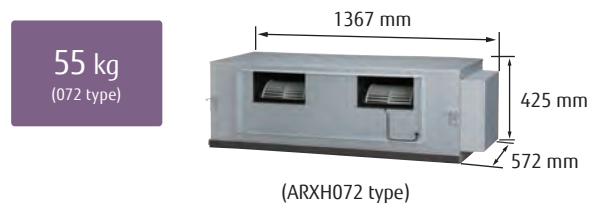

Various Controller

Supplied variety of controllers as options, such as individual controller, central controller, and building management controller.

Individual Controller



Central Controller



* The temperature setting is discharged air temperature setting. The air volume is set to a constant speed.

Specifications

Rated flow rate	1,000 m ³ /h		1,500 m ³ /h		2,000 m ³ /h	
Model name	ARXH054GTAH		ARXH072GTAH		ARXH096GTAH	
Power source	V/Ø/Hz		230/1/50		230/1/50	
Capacity	Cooling	kW	14.0	22.4	28.0	
	Heating	kW	8.9	13.9	17.4	
Input power	Cooling	W	179	292	370	
	Heating	W	179	292	370	
Airflow rate	m ³ /h		1,080	1,680	2,100	
Static Pressure	Standard (range)	Pa	185 (50-185)	200 (50-200)	200 (50-240)	
	Sound Pressure Level	dB(A)	42	44	47	
Dimensions (H × W × D)	mm		425 × 1,367 × 572	425 × 1,367 × 572	450 × 1,583 × 700	
Weight	kg		48	55	71	
Connection pipe diameter	Small	mm	9.52 (Flare)	12.70 (Brazing)	12.70 (Brazing)	
	Large	mm	19.05 (Flare)	22.22 (Brazing)	22.22 (Brazing)	
Operating range	Cooling	°CDB	5 to 43	5 to 43	5 to 43	
	Heating	°CDB	-7 to 21	-7 to 21	-7 to 21	
Refrigerant			R410A	R410A	R410A	

Note : Specifications are based on the following conditions.

Cooling : Outdoor temperature of 33°CDB / 28°CWB.

Heating : Outdoor temperature of 0°CDB / -2.9°CWB.

Pipe length : 7.5 m Voltage : 230 [V].

Dimensions (Unit: mm)

Model: ARXH054

Model: ARXH072

Model: ARXH096

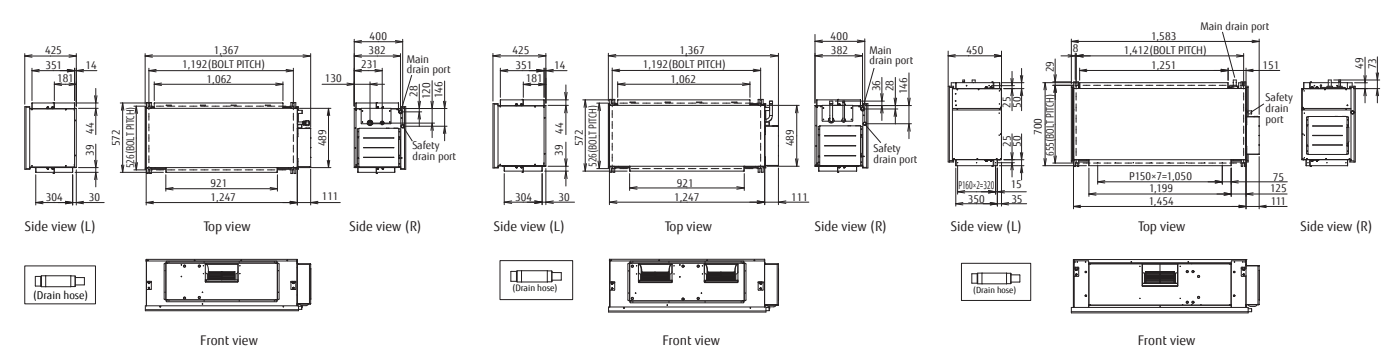

DX Kit for air handling applications

Models

Control unit
UTY-VDGX

EEV unit
UTP-VX30A
UTP-VX60A
UTP-VX90A

These kits enable other manufacturers air handling units (AHU) and fan coil units (FCU) to be incorporated into a Fujitsu VRF system or, be connected to a dedicated Fujitsu VRF outdoor unit as a 1:1 system to control outside air ventilation (AHU) or room temperature (FCU).

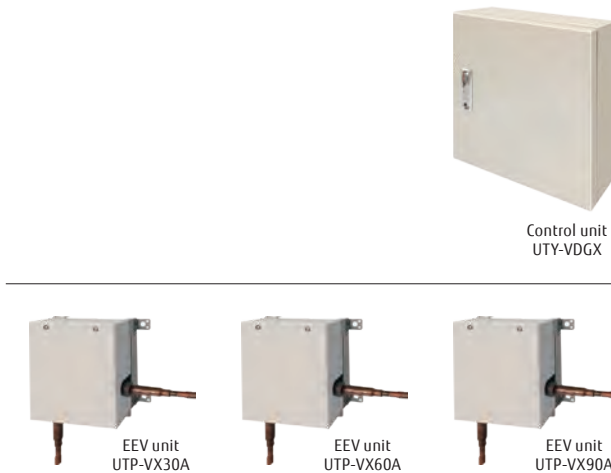

Feature

Multiple temperature sensors optimally control the air handling unit and fan coil unit.

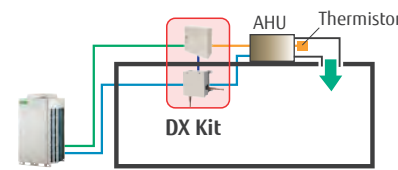

When connecting to an air handling unit, the supply air temperature is controlled by the discharge sensor.

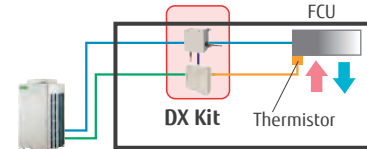

When connecting to a fan coil unit, the room temperature is controlled by the return air temperature sensor.

Arrangement as part of a VRF system

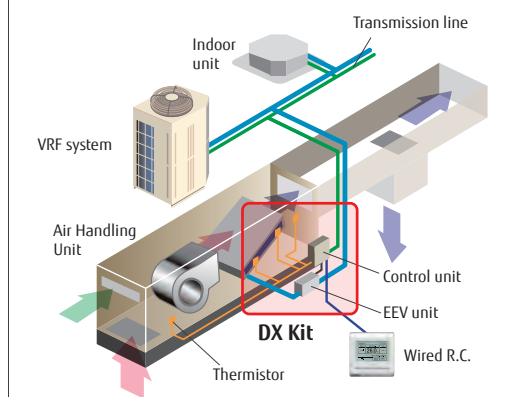

Supports a wide range of capacity classes

- 2 EEV units can be connected in parallel and up to 20 HP (50 kW) large capacity units. (Separation Tube of UTP-LX180A is required.)
- Connectable capacity range: 5 kW to 50 kW

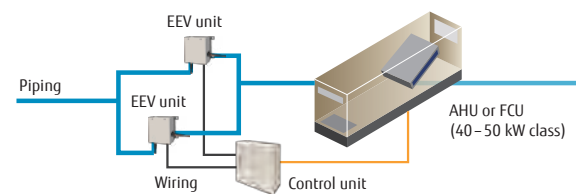

A variety of controls to match the application

- Central control using our VRF controllers or central management controllers

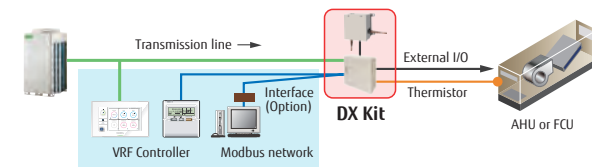

- Central control from external controllers

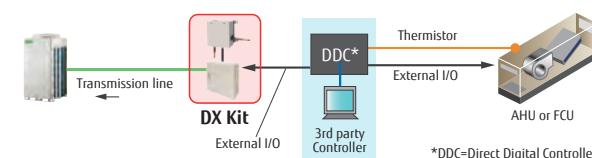

*DDC=Direct Digital Controller

Functions Summary

Inputs

- ON/OFF
- Setting temperature
- Capacity demand
- Heating / Cooling operation mode
- Fault information

Outputs

- ON/OFF indication
- Fan ON/OFF indication
- Thermo ON/OFF indication
- Defrost indication
- Fault indication

Modbus Control

- Possible to control via a Modbus enabled BMS by using optional interface.

Installation Limitation

- Connectable VRF Series : All VRF
- Connectable DX Kit system capacity range : 50 to 100 % of the outdoor unit capacity
- Connectable DX Kit system capacity range with indoor units : 30 % or less of the outdoor unit capacity
- Max. wiring length from control unit : 10 m
- Max. piping length between EEV unit and indoor unit : 5 m
- Outdoor installation : Control unit (IP54 class) and EEV unit can be installed at an outdoor space.

[For 2EEV units connection (option)]

- Separation Tube : UTP-LX180A



Connectable capacity

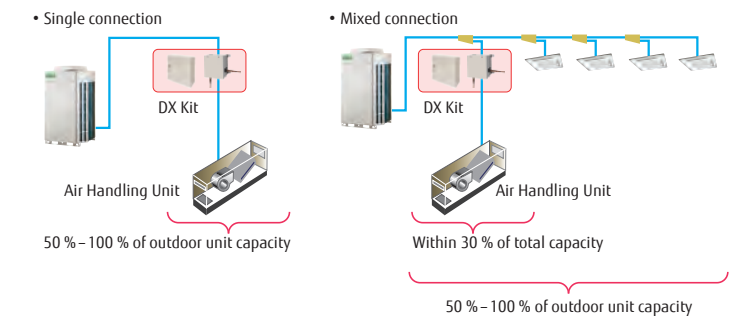

Piping and wiring length

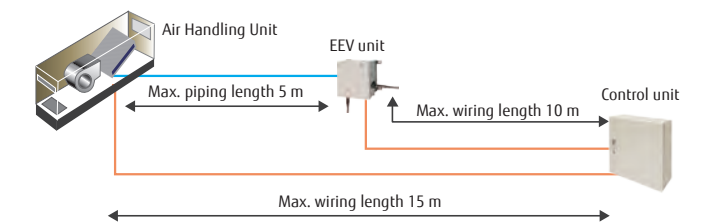

Specifications

EEV unit		UTP-VX30A				UTP-VX60A			UTP-VX90A		UTP-VX90A*2	
Power source	V/Ø/Hz	230/1/50										
Connectable capacity class	kW	5.0	6.3	8.0	10.0	12.5	14.0	20.0	25.0	40.0	50.0	
Capacity	Cooling	5.6 (5.1-5.9)	6.3 (6.0-7.1)	8.0 (7.2-9.0)	10.0 (9.1-11.1)	12.5 (11.2-13.2)	14.0 (13.3-18.0)	22.4 (18.1-23.7)	25.0 (23.8-28.0)	40.0 (28.1-44.7)	50.4 (44.8-50.4)	
	Heating	6.3 (5.7-6.7)	7.1 (6.8-8.0)	9.0 (8.1-10.0)	11.2 (10.1-12.4)	14.0 (12.5-15.0)	16.0 (15.1-20.0)	25.0 (20.1-26.5)	28.0 (26.6-31.5)	45.0 (31.6-49.9)	56.5 (50.0-56.5)	
Airflow Rate(Reference value)	m ³ /h	1,060	1,200	1,520	1,600	2,000	2,240	3,560	4,000	6,400	8,000	
Dimensions (H × W × D)	mm	160 × 220 × 90										
Weight	kg	2										
Connection pipe diameter	Liquid mm	9.52	9.52	9.52	9.52	9.52	9.52	12.70	12.70	12.70	12.70	

Control unit		UTY-VDGX	
Power source	V/Ø/Hz	230 / 1 / 50	
Dimensions (H × W × D)	mm	400 × 400 × 120	
Weight	kg	10	

Note : Specifications are based on the following conditions.
Cooling : Indoor temperature of 27°CDB / 19°CWB, and outdoor temperature of 35°CDB / 24°CWB.
Heating : Indoor temperature of 20°CDB / (15°CWB), and outdoor temperature of 7°CDB / 6°CWB.
Pipe length : 7.5 m Voltage : 230 [V].

CONTROL SYSTEMS

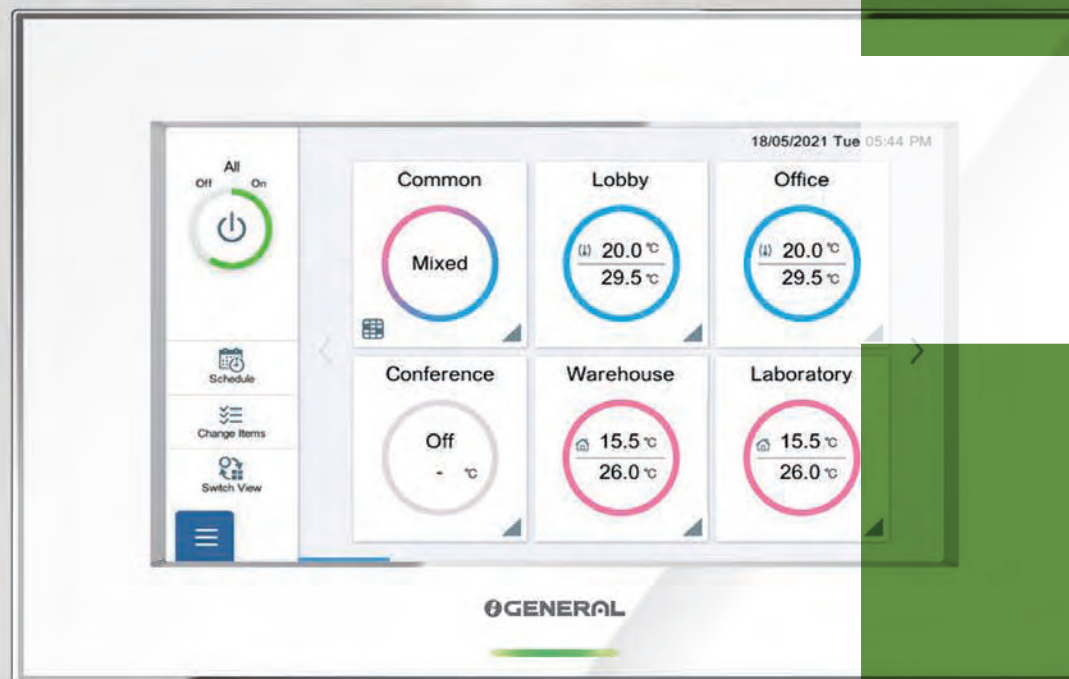

User friendly control system provides individual control to centralized control

The VRF control system can perform air conditioning control of individual room, centralized control by floor or by building, or centralized energy saving air conditioning control for large buildings.

A variety of air conditioning management schemes are available to match the application, such as linking with the building control system, linking with a single split models, and using various interfaces.

BEST CONTROL SOLUTION FOR EACH PROPERTY

CONTROL SYSTEM OVERVIEW

COMPARISON TABLE OF CONTROLLERS

INDIVIDUAL CONTROLLER

CENTRALIZED CONTROLLER







CONVERTER / ADAPTER













BEST CONTROL SOLUTION FOR EACH PROPERTY

Fujitsu General provides the best control solutions suitable for the various properties.









SHOP

Type	Individual Control			Centralized Control			Integrating Control (Interface)			
										
	Wired Remote Controller	Central Remote Controller	Touch Panel Controller	System Controller	Network Converter for LonWorks™	MODBUS™ Converter	KNX™ Converter			
	UTY-RNRGZ5, UTY-RLRG, UTY-RCRGZ1, UTY-RCRGZ1K	UTY-DCGGZ2	UTY-DTGGZ1	UTY-APGXZ1, UTY-ALGXZ1	UTY-VLGX	UTY-VMGX	UTY-VKGX			
Automatic control of A/C (Schedule timer, Weekly timer etc.)	●	●	●	●						
Limited control for staff (RC Prohibition, Room temp set point limitation etc.)		●	●	●	●	●	●			
Group Control		●	●	●						
Advanced Energy Saving (Peak cut, Indoor unit lead lag operation etc.)				●						
Remote Management			●	●						
Manage multiple sites			●	●						
Monitor energy consumption				●						
Control third party products				●						
Integrate FGL A/C into BMS					●	●	●			

HOTEL

Type	Individual Control			Centralized Control			Integrating Control (Interface)				
											
	Wired Remote Controller	Simple Remote Controller	Wireless Remote Controller	Central Remote Controller	Touch Panel Controller	System Controller	BACnet™ Gateway	Network Converter for LonWorks™	MODBUS™ Converter	KNX™ Converter	External Switch Controller
	UTY-RNRGZ5, UTY-RLRG, UTY-RCRGZ1, UTY-RCRGZ1K	UTY-RSRG, UTY-RHRG	UTY-LNHG	UTY-DCGGZ2	UTY-DTGGZ1	UTY-APGXZ1, UTY-ALGXZ1	UTY-ABGXZ1, UTY-VBGX	UTY-VLGX	UTY-VMGX	UTY-VKGX	UTY-TERX
Local control for hotel guest	●	●	●								
Centralized A/C control for common space				●	●	●	●	●	●	●	
Limited control for hotel guests				●	●	●	●	●	●	●	
Remote Management					●	●					
Advanced Energy Saving (Peak cut, Indoor unit lead lag operation etc.)						●	●				
Monitor energy consumption						●					
Control third party products						●					
Integrate FGL A/C into BMS							●	●	●	●	
Interlock with window contact											●
Interlock with key-card											●

OFFICE

Type	Individual Control			Centralized Control			Integrating Control (Interface)				
											
	Wired Remote Controller	Simple Remote Controller	Wireless Remote Controller	Central Remote Controller	Touch Panel Controller	System Controller	BACnet™ Gateway	Network Converter for LonWorks™	MODBUS™ Converter	KNX™ Converter	External Switch Controller
	UTY-RNRGZ5, UTY-RLRG, UTY-RCRGZ1, UTY-RCRGZ1K	UTY-RSRG, UTY-RHRG	UTY-LNHG	UTY-DCGGZ2	UTY-DTGGZ1	UTY-APGXZ1, UTY-ALGXZ1	UTY-ABGXZ1, UTY-VBGX	UTY-VLGX	UTY-VMGX	UTY-VKGX	UTY-TERX
Local control for office staff	●	●	●	●							
Automatic control of A/C (Schedule timer, Weekly timer etc.)	●		●	●	●	●	●				
Centralized A/C control for management				●	●	●	●	●	●	●	
Limited control for office staff (RC Prohibition, Room temp set point limitation etc.)				●	●	●	●	●	●	●	
Advanced Energy Saving (Peak cut, Indoor unit lead lag operation etc.)						●	●				
Remote Management				●	●	●					
Energy Charge Apportionment					●	●	●				
Monitor energy consumption						●					
Control third party products						●					
Integrate FGL A/C into BMS							●	●	●	●	
Interlock with door contact											●
Interlock with human sensor for meeting room				●							●

CONTROL SYSTEM OVERVIEW

User's needs are supported by offering a variety of controls, such as individual control, central control and building management control options.

Air Conditioning Individual Control

- Wired Remote Controller (Touch panel)**
UTY-RNRGZ5
- Wired Remote Controller**
UTY-RLRG
- Compact Wired Remote Controller**
UTY-RCRGZ1
UTY-RCRGZ1K
- Simple Remote Controller**
UTY-RSRG
UTY-RHRG Without operation mode
- Wireless Remote Controller**
UTY-LNHG
- IR Receiver Unit**
UTB-YWC For Duct type
UTY-TRHX For 3D Flow Cassette / Duct
UTY-LRHGB1 For Cassette type
UTY-LBHXD For Circular Flow Cassette

Air Conditioning Centralised Control

- System controller (Software)**
UTY-APGXZ1
UTY-ALGXZ1 (Lite edition)
Maximum controllable **1600*** indoor units
* Lite edition is maximum controllable 400 indoor units
- Touch Panel Controller**
UTY-DTGGZ1
Maximum controllable **400** indoor units
- Central Remote Controller**
UTY-DCGGZ2
Maximum controllable **100** indoor units



Converter / Adaptor For external device

- BACnet™ Gateway**
UTY-ABGXZ1 **Software**
- BACnet™ Gateway**
VTY-VBGX **Hardware**
- Network Converter For LonWorks™**
UTY-VLGX
- MODBUS™ Converter For VRF**
UTY-VMGX
- MODBUS™ Converter For Indoor unit**
UTY-VMSX
- KNX™ Converter For VRF**
UTY-VKGX
- KNX™ Converter For Indoor unit**
UTY-VKSX
- Wireless LAN Adaptor**
FJ-RC-WIFI-1 / UTY-TFSXZ2
- External Switch Controller**
UTY-TERX

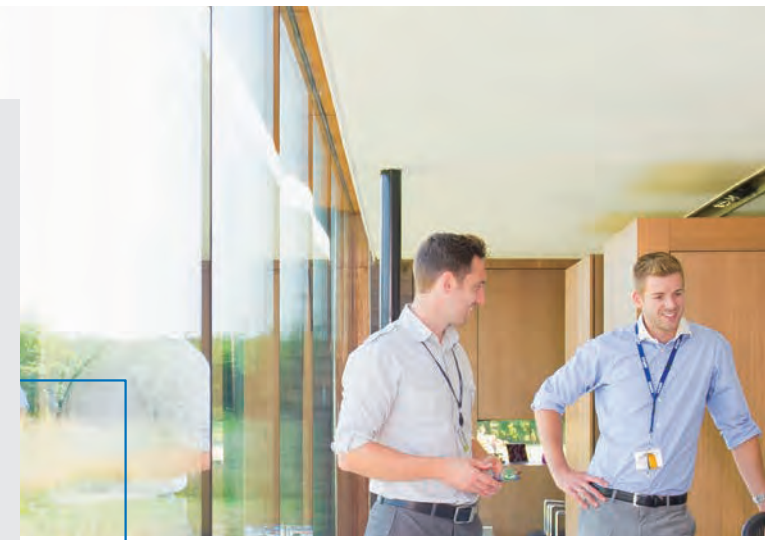

BMS / BAS*2











BMS, Home automation system

*1. USB Adaptor: Echelon™ U10 USB Network Interface
*2. BMS/BAS: Building Management System/Building Automation System

Converter / Adaptor For system expansion

- Signal Amplifier**
UTY-VSGXZ1

COMPARISON TABLE OF CONTROLLERS

Item											
	Wired Remote Controller (Touch panel)	Wired Remote Controller	Compact Wired Remote Controller	Compact Wired Remote Controller	Simple Remote Controller	Simple Remote Controller*1	Wireless Remote Controller	Central Remote Controller	Touch Panel Controller	System Controller Lite (Software)	System Controller (Software)
Model name	UTY-RNRGZ5	UTY-RLRG	UTY-RCRGZ1	UTY-RCRGZ1K	UTY-RSRG	UTY-RHRG	UTY-LNHG	UTY-DCGGZ2	UTY-DTGGZ1	UTY-ALGXZ1	UTY-APGXZ1
Max. controllable remote controller groups	1	1	1	1	1	1	1	100	400	400	1600
Max. controllable indoor units	16	16	1	1	16	16	16	100	400	400	1600
Max. controllable groups	-	-	-	-	-	-	-	50	400	400	1600
Air conditioning control function	On / Off	●	●	●	●	●	●	●	●	●	●
	Operation mode setting	●	●	●	●	●	-	●	●	●	●
	Fan speed setting	●	●	●	●	●	●	●	●	●	●
	Room temp. setting	●	●	●	●	●	●	●	●	●	●
	Room temp. set point limitation	●	●	-	-	●	●	-	●	●	●
	Test operation	●	●	●	●	●	●	-	●	-	-
	Up/down air direction flap setting	●	●	●	●	●	●	●	●	●	●
	Right/left air direction flap setting	●	●	●	●	-	-	●	●	●	●
	Individual louver control	●	-	●	●	-	-	-	●*3	●	-
	Group setting	-	-	-	-	-	-	-	●	●	●
	RC prohibition	-	-	-	-	-	-	-	●	●	●
	Anti freeze setting	●	-	●	●	-	-	-	●	●	●
	Set temp. auto return	●	●	-	-	-	-	-	-	●	-
	Economy mode setting	●	●	●	●	-	-	●	●	●	●
Human sensor control	●	-	-	-	-	-	-	●	●	●	
Display	Error	●	●	●	●	●	-	●	●	●	●
	Defrosting	●	●	●	●	●	-	●	●	●	●
	Current time	●	●	-	-	-	●	●	●	●	●
	Day of week	●	●	-	-	-	-	●	●	●	●
	R.C. prohibition	●	●	●	●	●	●	-	●	●	●
	Address display	●	●	●	●	●	●	-	●	●	●
	Room temp	●	-	●	●	●	●	●*4	●*4	●*4	●*4
	Multi-language	●	-	-	-	-	-	●	●	●	●
	Summer time	●	-	-	-	-	-	●	●	●	●
	Name registration	●	-	-	-	-	-	●	●	●	●
	Backlight	●	-	●	●	●	●	-	●	●	-
	2D floor layout / 3D building display	-	-	-	-	-	-	-	-	-	●
	Refrigerant leakage detection function	-	-	-	-	-	-	-	●	●	●
	Timer	Schedule timer	Period On/off, Temp, Mode, Times per day	Week	Week	-	-	-	Week	Year	Year
			8	4	-	-	-	20	20	144	144
On/off timer		●	●	●(OFF only)	●(OFF only)	-	●	-	-	-	-
Sleep timer		-	-	-	-	-	●	-	-	-	-
Program timer		-	-	-	-	-	●	-	-	-	-
Auto off timer		●	●	-	-	-	-	●	●	-	-
Day off	●	●	-	-	-	-	●	●	●	●	
Min. unit of timer setting (Minutes)	10 • 30	30	-	-	-	5	10	10	10	10	
Control	Status monitoring system	-	-	-	-	-	-	●	●	●	●
	Electricity charge apportionment	-	-	-	-	-	-	-	○	○	●
	Error history	●	●	-	-	-	-	●	●	●	●
	Emergency stop	-	-	-	-	-	-	●*2	●*2	-	-
	Remote management	-	-	-	-	-	-	●	●	○	●
	Energy saving management	-	-	-	-	-	-	-	-	○	○
	E-mail notification for malfunction	-	-	-	-	-	-	●	●	●	●
	Key lock	● Child lock	● Child lock	-	-	-	-	-	● Password setting	● Password setting	● Password setting
Low noise mode	-	-	-	-	-	-	-	●	●	●	

*1 "Operation mode" setting is not available for this model. *2 This function is available only through external input control.
 *3 Only individual airflow group reset is mounted. *4 This function is available only when using wired remote controller.
 ●: Supported ○: Optional function -: Not supported yet

Wired Remote Controller (Touch Panel)

Maximum controllable
16
indoor units

UTY-RNRGZ5

Easy operation by high-definition large STN-LCD touch panel screen

- Easy finger touch operation with LCD panel
- Built-in weekly/Daily timer (ON/OFF, Temp., Mode)
- Backlight enables easy operation in a darkened room
- Room temperature display
- Control up to 16 indoor units
- Corresponds to 12 different languages (English, Chinese, French, German, Spanish, Russian, Polish, Italian, Greek, Portuguese, Turkish and Dutch)
- 2-wire type

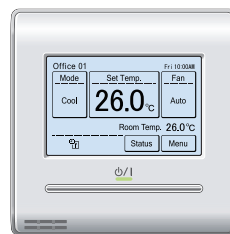

Functions

High performance and compact size

- In addition to the individual control, various energy saving controls can be realized using one remote controller only.



Accurate and comfortable control

- Indoor temperature can be detected accurately by the inclusion of a thermo sensor in the body of the wired controller.

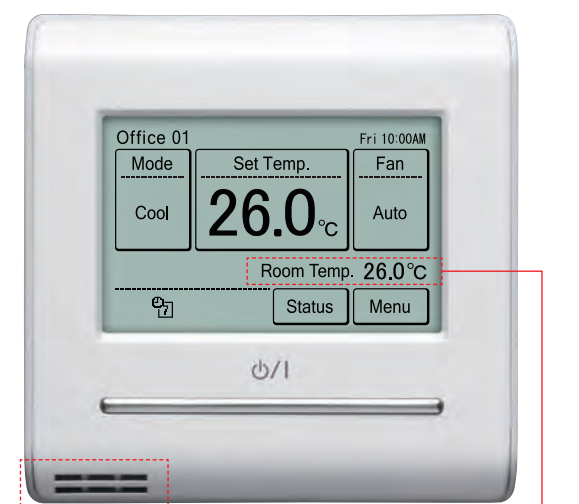

Room temperature sensor

Room temperature display

Various energy saving control

Custom Auto

- Maintains 2 separate set points for heating and cooling.
- Automatically changes mode between heating and cooling.
- * This function is not available for some models.

Cooling set temp. 27°C, Heating set temp. 26°C

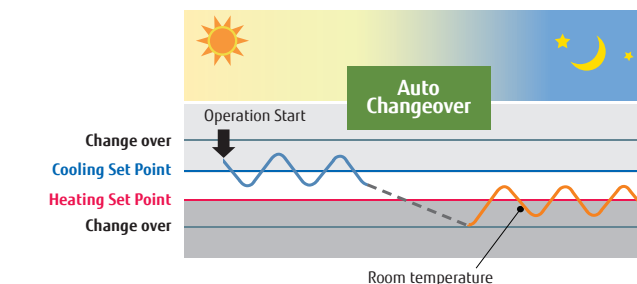

Auto OFF timer

- The indoor unit automatically is turned off when it reaches to the preset operating time frame.
- The time frame of the "Auto off timer" can be flexibly scheduled.
- Can be set off time 30 to 240 minutes

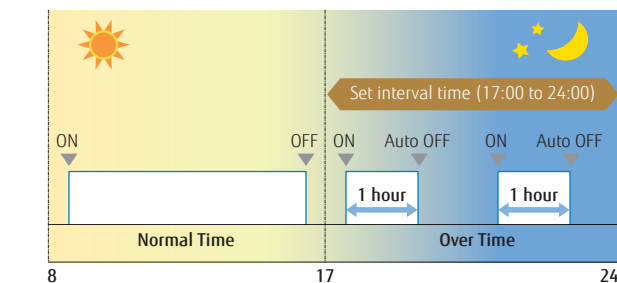

Ex.) At interval time hour (17:00 to 24:00) to prevent forgetting to turn off
Set off time : 1 hour

- 2 schedules Weekly Timer
- Set Temperature Auto Return
- Set Temperature Upper and Lower Limit Setting

Specifications

Model name	UTY-RNRGZ5	
Power Supply	DC 12V	
Dimensions (H x W x D)	mm	120 x 120 x 20.4
Weight	g	220

DC12V is supplied by indoor unit.

Wired Remote Controller

Maximum controllable
16
indoor units

UTY-RLRG

- Various timer setup (ON / OFF / WEEKLY) are possible.
- The room temperature can be controlled by detecting the temperature accurately with Built-in thermo sensor.
- When a failure occurs, the error code is displayed.
- Error history. (Last 16 error codes can be accessed.)
- 2-wire type



Functions

High performance and compact size

- In addition to the individual control, weekly timer, and various energy saving controls can be realized using only one remote controller.



Auto-off timer

- The indoor unit automatically turns off after a set time has passed.

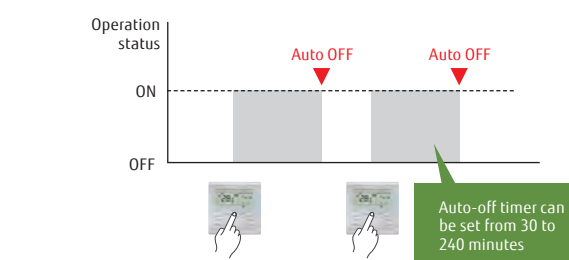

Weekly timer function

- Not only time setting On / Off, but also setting of the operation mode and set temperature can be set by Weekly timer function.

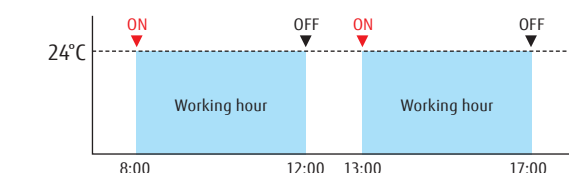

4 types (ON, OFF, ON, OFF) can be set on every day of the week in a week.

Specifications

Model name	UTY-RLRG	
Power Supply	DC 12V	
Dimensions (H x W x D)	mm	120 x 120 x 17
Weight	g	170

DC12V is supplied by indoor unit.

High visibility and easy operation

- "Mode", "Set Temp", and "Fan" are displayed at large size on the top screen.
- Each function to be set is indicated by an icon.
- Control guide is displayed and operation is simple and straightforward.

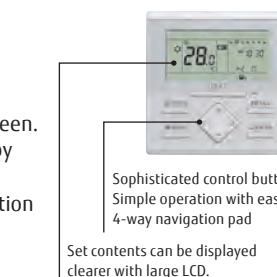

Set temperature auto return

- The setting temperature automatically returns to the previously set temperature.
- The time range in which the set temperature can be changed is 30 to 240 minutes.

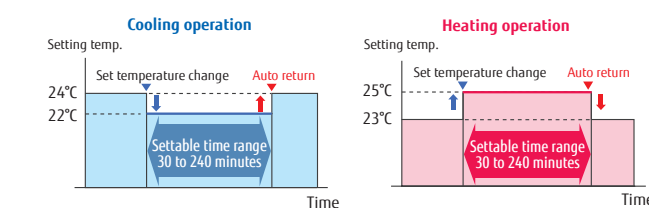

Set temperature upper and lower limit setting

- The set temperature range can be set for each operation mode. (Cooling / Heating / Auto)

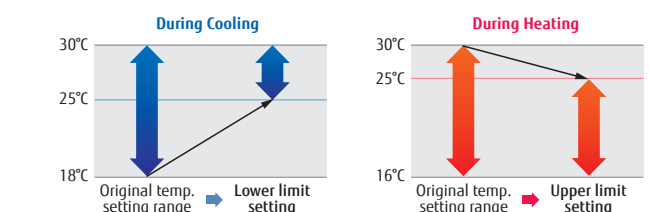

Compact Wired Remote Controller

Maximum controllable
1
indoor units

UTY-RCRGZ1
UTY-RCRGZ1K

- Simple design to match the stylish interior
- Easy to install : Body of controller is designed to fit in European standard junction box
- Can be operated both by wireless and wired remote controller.
- 2-wire type

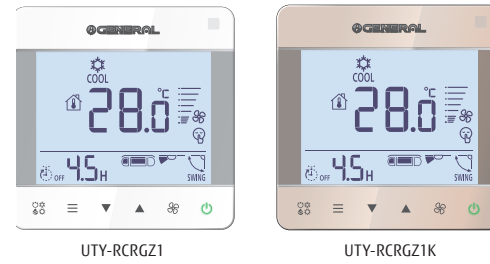

Functions

Large screen and simple display

- Although the size is compact, the screen is large
- Large letters makes it easy to see
- Operation is simple and easy-to-understand

- 1 Visible large letter
- 2 Touch key (Frequently-used operation is placed on the direct button)
- 3 Operation mode
- 4 Menu
- 5 Air flow
- 6 Built in IR reciever
- 7 LCD with backlight is clearly visible in the dark
- 8 Easy-to-understand pictograph display
- 9 LED is mounted for the ON/OFF key (Green light on when R.C. is turned on)

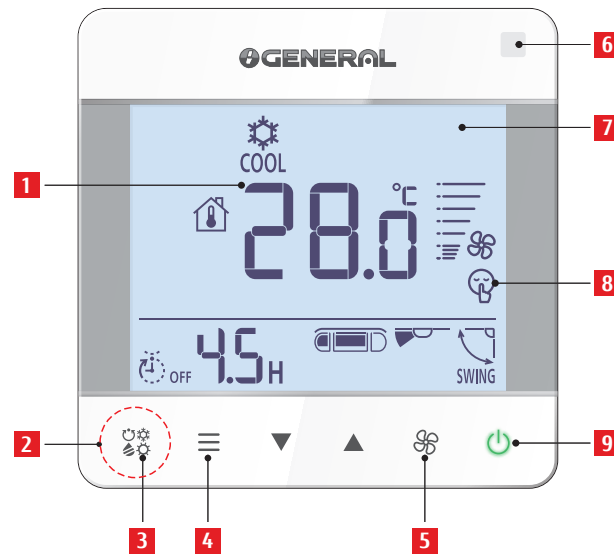

System overview

• VRF connection

One indoor unit and one remote controller are connected in one non-polar and 2-wire remote controller system.

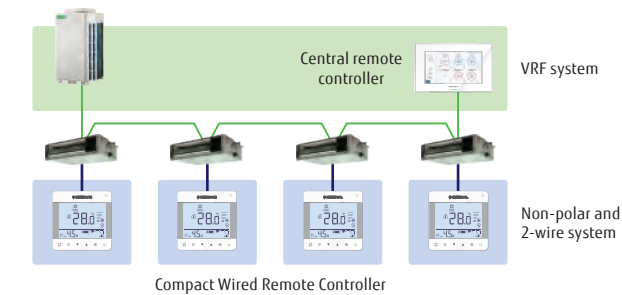

• RAC (Room air conditioner) connection

One indoor unit and one remote controller are connected in one non-polar and 2-wire remote controller system.

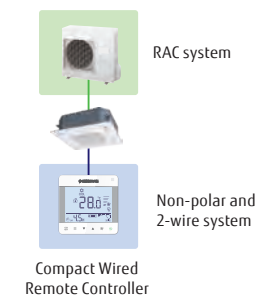

Specifications

Model name	UTY-RCRGZ1	UTY-RCRGZ1K
Power Supply	DC 12V	
Dimensions (H x W x D)	86 × 86 × 44	
Weight	135	

DC12V is supplied by indoor unit.

Simple Remote Controller

Maximum controllable
16
indoor units

UTY-RSRG

UTY-RHRG (Without Operation mode)

Compact remote controller provides access to basic functions

- Up to 16 indoor units can be controlled with one remote controller.
- Suitable for hotels or offices as it is easily operated with no complex functions.
- Stylish design: Simple design to match the stylish interior.
- Large LCD screen & simple operation buttons
- Backlight: White colored backlight on monitor enable easy operation in dark.
- 2-wire type

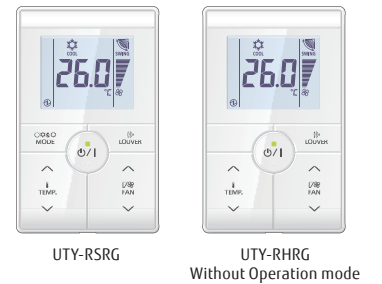

Functions

Corresponding to various applications

• Vertical louver control:

Vertical airflow direction can be adjusted for Duct types with auto louver and Cassette types, which are installed in hotels and conference rooms, can be adjusted.



• Room temperature set point limitation:

The Simple Remote Controller can manage to energy saving operation in small buildings without the central control unit.

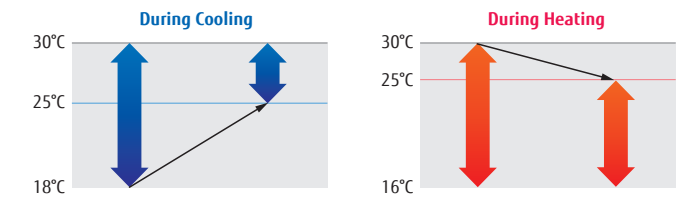

• Built in room temperature sensor:

The Simple Remote Controller detects actual room temperature and controls room climate accuracy.

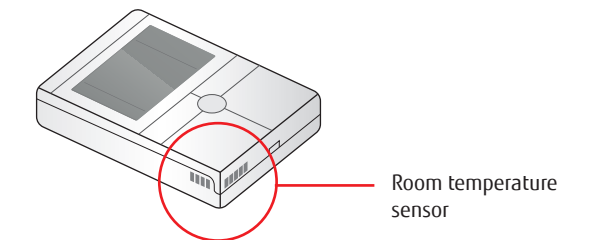

Specifications

Model name	UTY-RSRG	UTY-RHRG
Power Supply	DC 12V	
Dimensions (H x W x D)	120 × 75 × 19.4	
Weight	120	

Wireless Remote Controller

Maximum controllable
16
indoor units

Selectable
4
daily timers

UTY-LNHG

Simple and sophisticated operations with a choice of 4 daily timers

- A single controller controls up to 16 indoor units.



Functions

Built-in daily timer

Select from 4 different timer programs : On / Off / Program / Sleep

Program timer : The program timer operates the ON and OFF timer once within a 24 hour period.

Sleep timer : The sleep timer function automatically corrects the set temperature according to the time setting to prevent excessive cooling or heating during sleep hours.

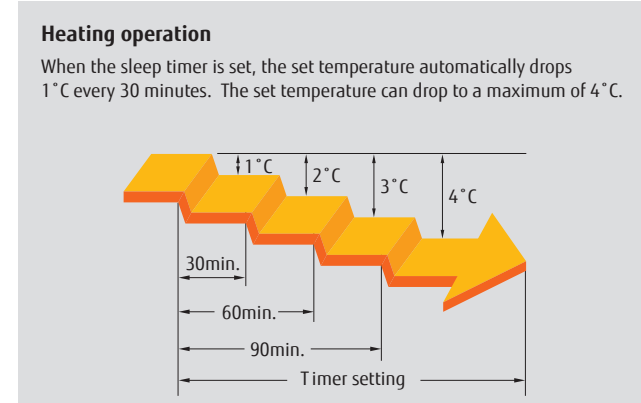
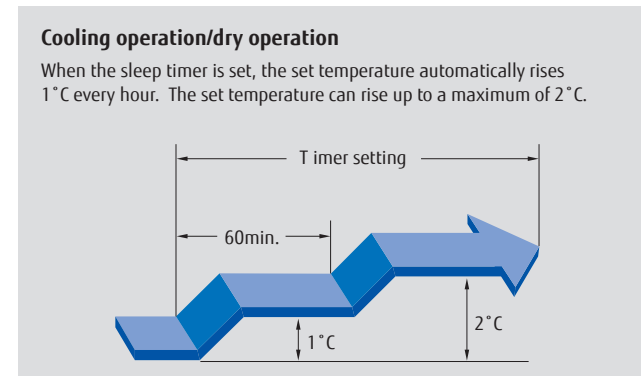

Easy installation and operation

Code selector switch prevents indoor unit mix-up. (Up to 4 codes can be set.)

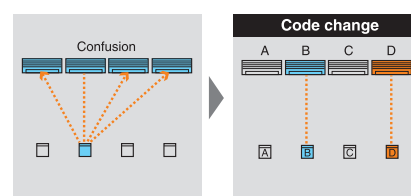

Wide and precise

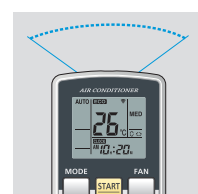

Address setting

During installation work, address setting can be performed using the Wireless Remote Controller, thus eliminating manual switch setting.

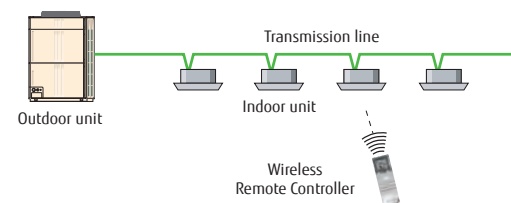

Specifications

Model name	UTY-LNHG	
Power Supply	1.5V (R03 / LR03 / AAA) × 2	
Dimensions (H x W x D)	mm	170 × 56 × 19
Weight	g	85

IR Receiver Unit for Duct

UTB-YWC, UTY-TRHX

Duct type indoor units can be controlled with Wireless Remote Controller

- Up to 16 indoor units can be controlled with one remote controller.
- Suitable for hotels or offices as it is easily operated with no complex functions.
- * The wireless remote controller (Model: UTY-LNHG) is necessary separately



Functions

Wiring connection

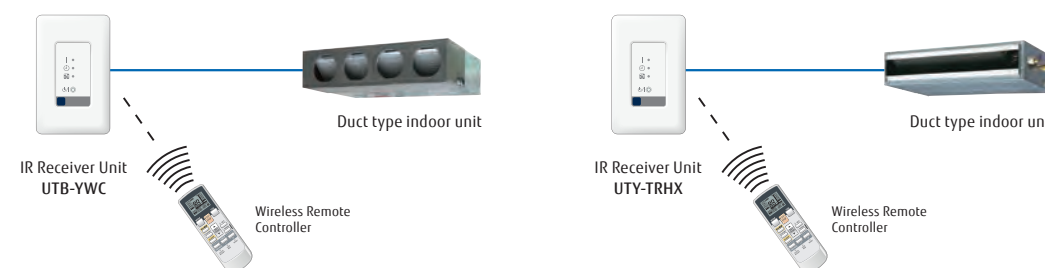

Specifications

Model name	UTB-YWC		UTY-TRHX	
Power Supply	DC 5V		DC 5V	
Dimensions (H x W x D)	mm	145 × 90 × 30	mm	145 × 90 × 30
Weight	g	150	g	150

IR Receiver Unit for Cassette

UTY-LRHGB1, UTY-LBHXD, UTY-TRHX

Cassette type indoor unit can be controlled with Wireless Remote Controller

- * The wireless remote controller (Model: UTY-LNHG) is necessary separately



Functions

Wiring connection



Specifications

Model name	UTY-LRHGB1		UTY-LBHXD		UTY-TRHX	
Power Supply	DC 5V		DC 5V		DC 5V	
Dimensions (H x W x D)	mm	193.9 × 193.9 × 31.2	mm	193.9 × 193.9 × 31.2	mm	145 × 90 × 30
Weight	g	140	g	140	g	150

Central Remote Controller

Maximum controllable
100
indoor units

Maximum controllable
50
groups

UTY-DCGGZ2

For small and medium-sized buildings and tenants

- Individual control and monitor of 100 indoor units
- 7.0inch TFT color screen
- High visibility and easy operation
- Room temperature display by indoor unit sensor & remote controller sensor
- 50 Remote Controller Groups Display & remote controller group rename
- Supports 12 different languages (English, Spanish, German, French, Italian, Russian, Portuguese, Turkish, Polish, Greek, Dutch, Chinese)



Functions

Easy Management

Air conditioning management by detecting room temperatures of each room

The room temperature detected with indoor unit sensor or remote controller sensor can be displayed. New model can detect the room temperature by indoor units sensors even if wired remote controllers are not connected to the indoor units.

Not connected wired remote controller
Indoor Unit Sensor
Thermistor

Connected wired remote controller
Remote Controller Sensor / other sensors
Thermistor

50 Remote Controller Groups Display

The group display and the 50 remote controller groups display can be switched easily. Users can choose which display is better, depending on the situation.

Group Display

50 Remote Controller Groups Display

One-tap to switch

Manage & Monitor by each Groups

Manage & Monitor by 50 Remote Controller Groups

Remote Controller Groups Rename

The remote controller group names can be changed. Users can know easily where the air conditioning is located by changing the remote controller group names.

The remote controller group name can be changed.

- Easy intuitive operation from the touch panel display.
- All functions can be accessed through the monitoring screen showing a pop-up window for detailed operation.

Monitoring screen

Individual setting

Added individual wind direction control
Individual wind direction control has been added.
Circular Flow cassette / 3D Flow cassette

Circular flow cassette

Human Sensor Compatible
Human sensor setting

- Auto save
- Auto on / off
- Auto off detection time
- Enable and disable

Remote Management

Remote monitoring / Remote operation

New central remote controller can control your tenant's air conditioner anytime and anywhere. When the central remote controller manages the indoor units of some tenants, air conditioning of each tenants can be managed separately online.

Increased the Number of Accounts

Administrator (Building owner)

Online users (Tenant owner)

Maximum 30 accounts

Trouble support function

Display error details
Display descriptive explanation when an error occurs

All indoor unit groups display

Display error details

- Indoor unit error
- Outdoor unit error
- Central remote controller error

Sensor value monitoring function
Monitor sensor data of indoor unit / outdoor unit, send mail

Notify room temperature by email*
Notify by e-mail when the temperature around the air conditioner is too high or too low

*:This function is available only when using wired remote controller.

Specifications

Model name	UTY-DCGGZ2	
Power supply	100-240 V 50 / 60 Hz	
Dimensions (H x W x D)	mm	134.6 x 216.2 x 37.9
Weight	g	800

Touch Panel Controller

UTY-DTGGZ1

- Large-sized 7.5-inch TFT colour
- LCD easy touch operation
- Stylish shape and design to suit all applications
- Up to 400 indoor units can be controlled
- Selectable 2 display types (icon / list) in monitoring mode
- Supports 7 different languages - English, Chinese, French, German, Spanish, Russian, Polish
- Mounted with LAN interface for remote control and operation, external input / output with emergency stop and batch ON / OFF

Maximum controllable 400 indoor units	Maximum controllable 100 outdoor units	Maximum controllable 400 groups
--	---	--



Functions

Easy operation

- Wide range of simple-to-understand icons
- Operation can be selected using your finger or the dedicated touch pen by pressing the appropriate on-screen icon.
- Back colour identifies current control operation: blue for monitoring; green for operational control.

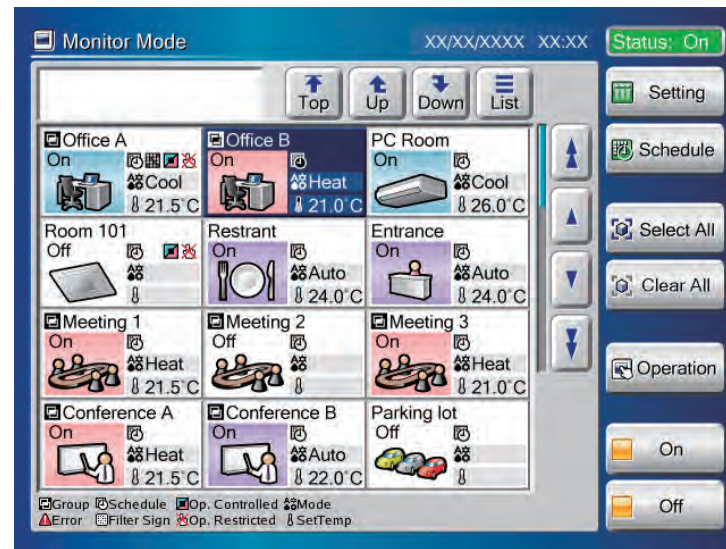

Easy maintenance

- Flat touch screen is easily cleaned
- Non glare coating on touch panel controller minimises fingerprint marking
- Easy to remove front cover



Easy installation

- The touch panel controller is easily mounted to the wall
- The flat back surface allows the controller to be installed wherever required
- No additional components are required for installation



Up to 400 indoor units can be controlled

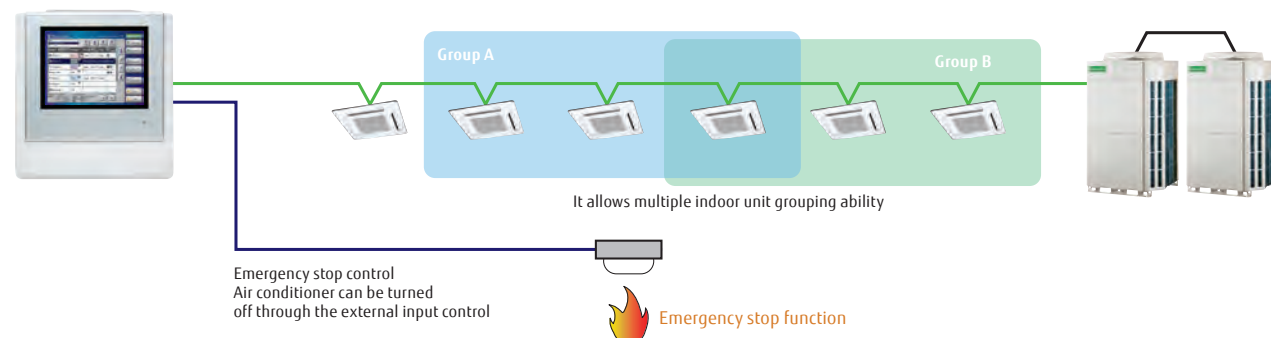

Control and monitoring

- Control and monitor Fujitsu air conditioners via LAN or Internet
- Allow the user or tenant to manage only assigned equipment by their PC or tablet from anywhere
- Error messages can be notified automatically by email upon an error occurrence to enable the issue to be handled promptly

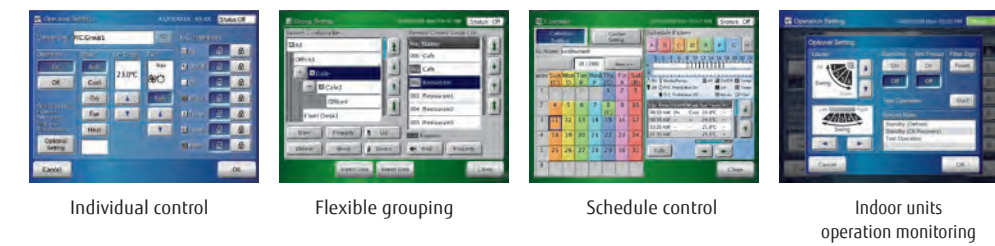
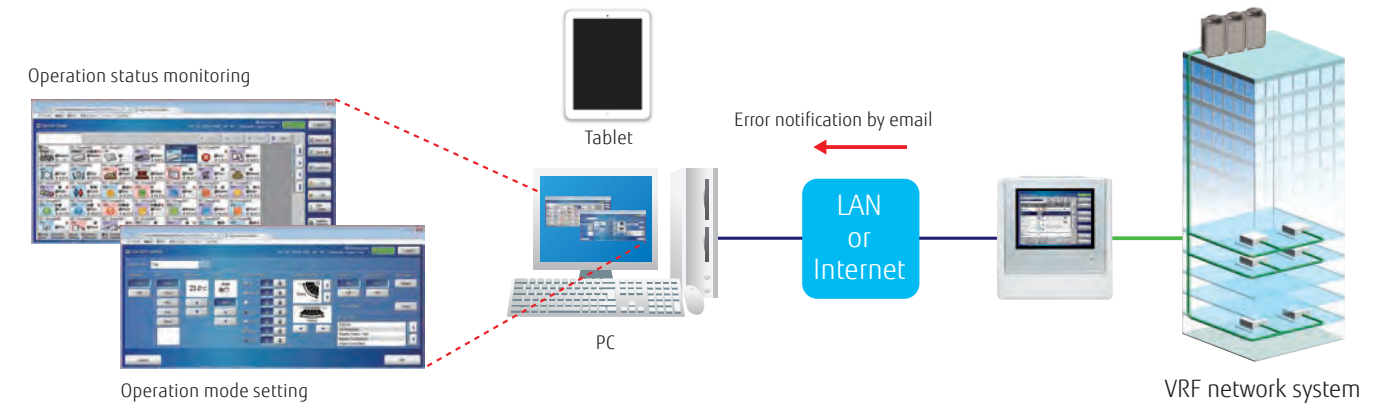

Not only operations but also detailed settings such as schedule or group settings can be operated from remote locations.

Smart phone

Model name	Browser
Nexus 6P (Android 7.1.1)	Google Chrome 5.5
iPhone 7 (iOS 10.1)	Safari 10

Tablet

Model name	Browser
iPad Pro 9.7inch (iOS 10.2.1)	Safari 10

Flexible access permission with individual user levels

The administrator can register multiple users to permit which indoor unit(s) and which functions can be accessed.

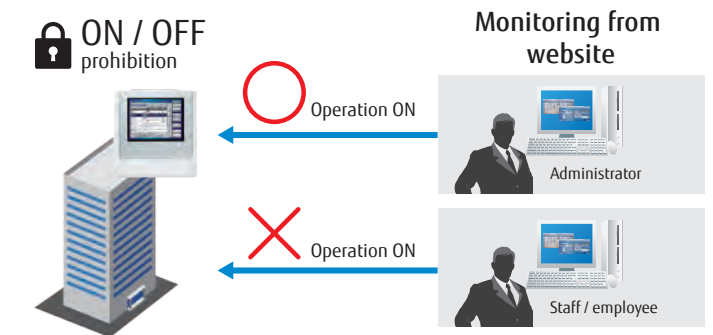

Additional language functionality

Available in 7 different languages- English, Chinese, French, German, Spanish, Russian and Polish as standard. Additional languages can be integrated on a remote device by creating a language database. Additional languages are displayed only on the remote device. The touch panel controller cannot be configured to display these additional languages.

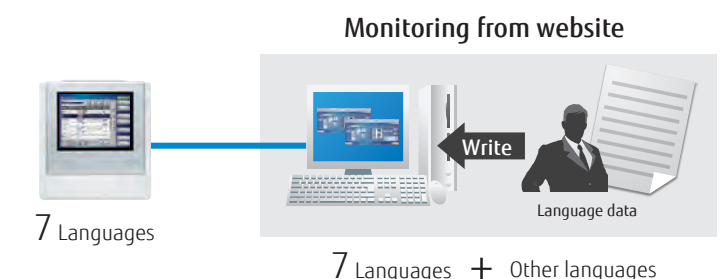

Functions

Electricity charge apportionment

Option UTY-PTGXA

- Electricity charge apportionment can be utilised to easily attribute power usage to each tenant based on their usage

- Apportionment charge / bill calculation
- Tenant (block) setting
- Common facilities apportionment setting
- Rated power consumption allotment setting
- Individual calculation for both cooling and heating
- Electricity meter supported

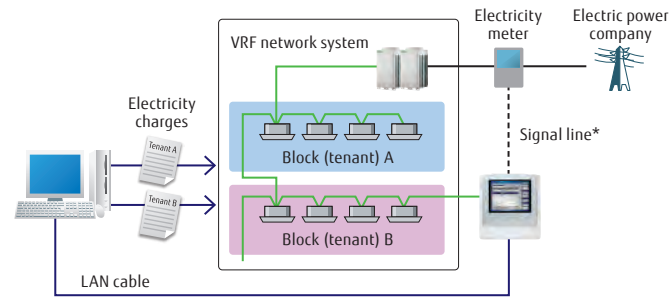

* Electricity meter (1 unit) can be connected to external input connector of the TPC unit. In this case, electricity meter cannot be connected to outdoor unit simultaneously.

Automatic summer time setting

Function overview

- This function enables a schedule to be set within the system to adjust the timer to summer time at the appropriate time to ensure the time matches the time zone.

Automatic clock adjustment

- The time setting of each controller can be set from the one location.

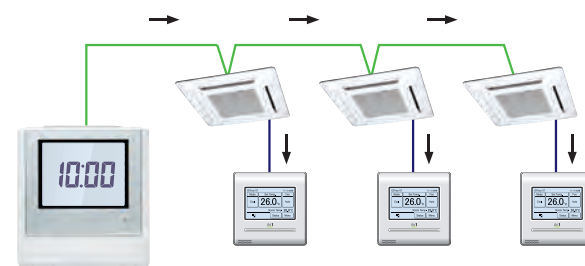

Outdoor low noise operation

Users can choose from 4 low noise levels, depending on the installation environment. The operation time can be set using the timer.

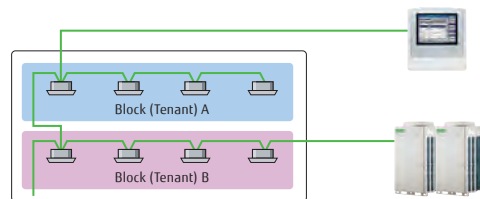

Quiet priority setting

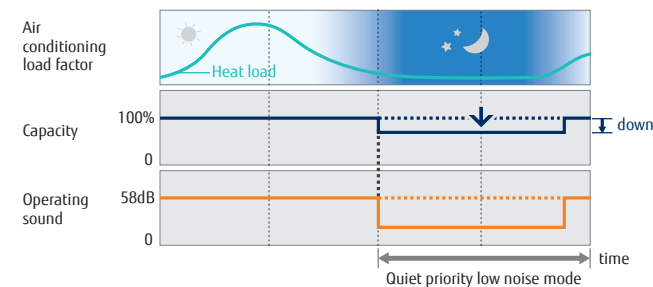

Energy saving control

Custom Auto

- Maintains 2 separate set points for heating and cooling
- Automatically changes mode between heating and cooling

* This function is not available for some models.

Cooling set temp. 27°C, heating set temp. 26°C

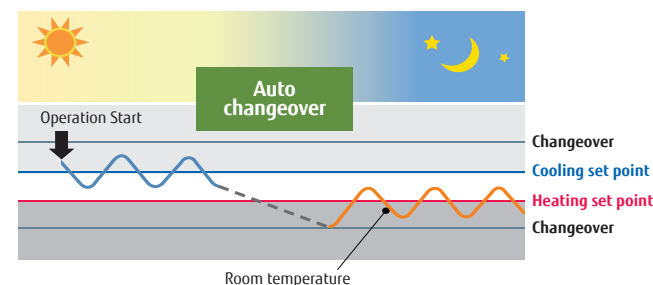

FUNCTIONS SUMMARY

	UTY-DTGGZ1	Monitoring side
Air conditioning control function		
On / Off	●	●
Operation mode setting	●	●
Fan speed setting	●	●
Room temp. setting	●	●
Room temp. set point limitation	●	●
Test operation	●	●
Up / down air direction flap setting	●	●
Right / left air direction flap setting	●	●
Individual louvre control	●*1	●
Group setting	●	●
RC prohibition	●	●
Anti freeze setting	●	●
Set temp. auto return	-	●
Various energy saving controls	-	●
Economy mode setting	●	●
Human sensor control	-	●
Custom Auto setting	●	●
Display		
Error	●	●
Defrosting	●	●
Current time	●	●
Day of week	●	●
R.C. prohibition	●	●
Cooling / heating priority	●	●
Address display	●	●
Room temp	●*3	●*3
Multi language	●	●
Summer time	●	●
Time zone setting	●	●
Name registration	●	●
Backlight	●	●
Language setting	7	7+other

●: Supported ○: Optional function -: Not supported yet

*1 Only setting cancellation can be operated.

*2 This function is available only through external input control.

*3 This function is available only when using wired remote controller.

	UTY-DTGGZ1	Monitoring side
Timer		
Schedule timer	Period	Year
	On / Off, temp, mode, times per day	20
On / Off timer	-	-
Sleep timer	-	-
Program timer	-	-
Auto off timer	-	●
Day off	●	●
Min. unit of timer setting (minutes)	10	10
Control		
Status monitoring system	●	●
Electricity charge apportionment	○	○
Error history	●	●
Emergency stop	●*2	●*2
Remote management	-	●
Energy saving management	-	-
Email notification for malfunction	-	●
Key lock	●	-
Low noise mode	●	●

Specifications

Model name		UTY-DTGGZ1
Power supply		100-240V 50 / 60Hz, Single phase
Dimensions (H x W x D)	mm	260 × 246 × 54
Weight	g	2,150
Interface		Transmission / LAN / USB / EXT IN / EXT OUT / Reset SW

System Controller Software

UTY-APGXZ1

System Controller realizes the advanced integrated monitoring & control of VRF network system from small scale buildings to large scale buildings.

- Up to a maximum of 4 VRF network systems, 1600 indoor units, and 400 outdoor units can be controlled.
- In addition to air conditioning precision control function, central remote control, electricity charge calculation, schedule management, and energy saving functions are strengthened and building manager and owner needs are met.

Maximum controllable VRF network systems	Maximum controllable indoor units	Maximum controllable outdoor units
4	1,600	400



Maximum controllable VRF network system	Maximum controllable indoor units	Maximum controllable outdoor units
1	400	100



System Controller Lite Software

UTY-ALGXZ1

System Controller Lite has standard functions sufficient for air conditioner management in small and medium scale buildings.

- Up to a maximum of 1 VRF network system, 400 indoor units, and 100 outdoor units can be controlled.
- In addition to air conditioning precision control function, a variety of management software is available as an option to give customers a wide range of choice.

Functions

User friendly view and operation

- **Click & Operate** : The property is shown visually from the perspective most suitable for operation and operated accordingly (Click & Operate). You can select from among the 4 displays of site, building, floor, or list.
- **Freely define groups for batched control** : Indoor units can be freely grouped for simple batched control from a tree menu. Grouping by hierarchal structure, such as by section, division or department is possible.

Click & Operate the whole building! Properties can be shown using one of the four displays of site, building, floor, or list.

Click & Operate any specified unit(s)!

Batched control of freely defined groups

Batched control of freely selected units

Click & Operate the whole floor!

Click & Operate the unit!

The floor layout drawing can be imported to easily make the settings for the actual building.

Set Temp. [Custom Auto] (* C)	
Cool	Heat
27.0	23.0
25.5	23.0

3rd party devices connected by Modbus can be controlled.

When Modbus Adaptor (locally purchased) is connected to PC, the electric facilities supported by Modbus can be controlled centrally. Wasteful electricity charge by forgetting to turn off and patrol activities can be reduced in the entire building.

Standard for System Controller
Option for System Controller Lite UTY-PLGXX2

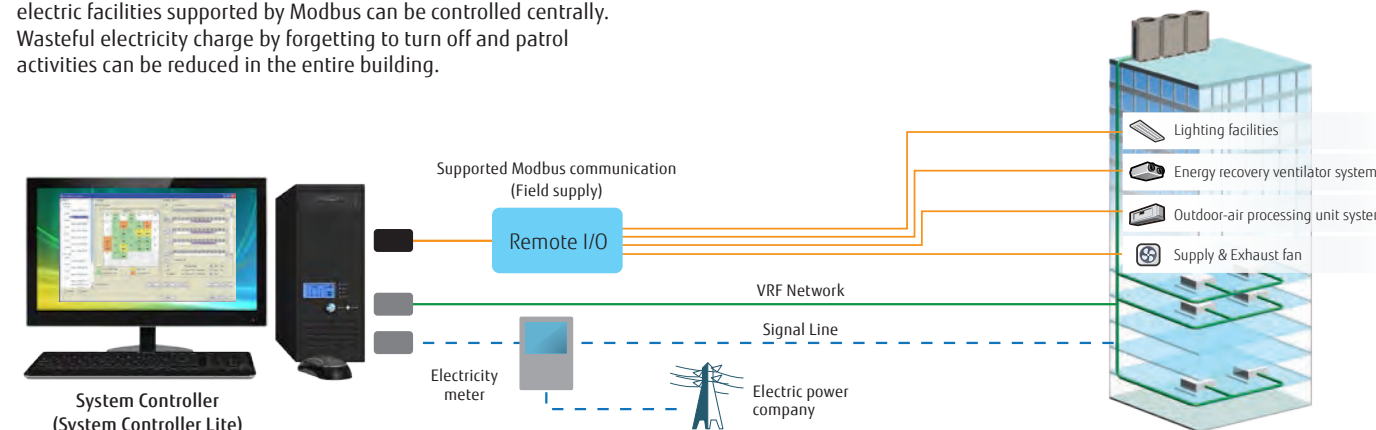

Diverse operation management & Data management

Schedule management

- Annual schedules can be set for each remote controller group / user defined group.
- Start / stop, operating mode, remote controller prohibition, and temperature settings can be set up to 143 times per day at 10 minute intervals for up to 101 configurations for each remote controller group.
- Settings can be made for periods straddling midnight.
- Allows programming of special settings for holidays, including public holidays, for a complete year.
- Low noise operation of outdoor unit can be scheduled.

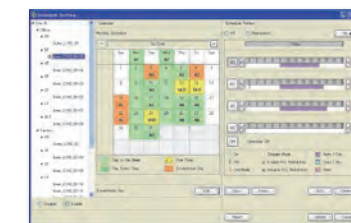

Diverse control of indoor unit

- Indoor unit operation state, operation mode, etc. are displayed
- Indoor unit start / stop and operation mode switching
- Room temperature set point limitation

Remote controller prohibition

This prohibits changes to the operation mode, temperature, start/stop, etc.

Automatic clock adjustment

The time setting of each controller can be set in batch automatically.

Electricity charge apportionment

Electricity charge apportionment calculation framework
Suppose you want to find the power consumed by the air conditioners of each tenant from the electricity charge for each month. With electricity charge apportionment function, used energy apportionment ratio will be provided, calculating in detail the energy consumed by the units used by each tenant. This information is then used to calculate the charges for the electricity consumed for air conditioning by each tenant from the total electricity charges in the bill from the electric power company. (See figure at right)
The detailed calculation takes into consideration such things as unused rooms and nighttime electricity charges and shows them in a charges calculation sheet.

Standard for System Controller
Option for System Controller Lite UTY-PLGXA1

System Configuration Example

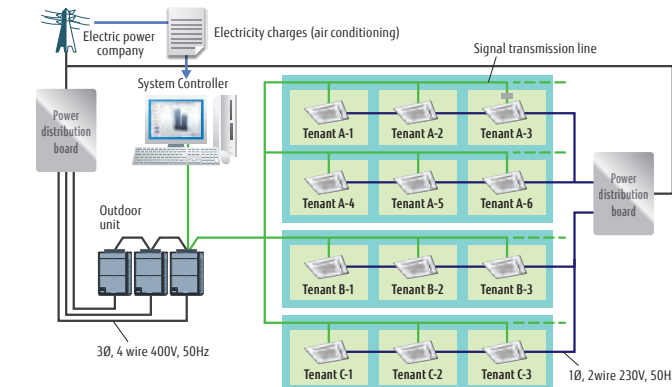

Error display & E-mail notification

Error is notified with popup message, audible sound and E-mail real time when error occurs. Error for the past 1 year are logged and can be reviewed later.

Data base import/export

Imports/exports registration data, layout data, and image data. Only the administrator can make this setting.

Operating & control record

Displays the history of operation status and control.

Remote management

System Controller may be used on site or remotely over various networks for remote central control. System Controller requires 2 softwares working together. VRF Controller runs on site and communicate with VRF system. VRF Explorer runs remotely and provides user interface and communicate with the VRF Controller. VRF Controller and VRF Explorer program may run in a single PC or in different PCs separated by network. By using VRF Explorer software, one PC can perform central control of 10 VRF system sites with max. 20 buildings per site.

Remote central control

1 VRF Controller can be monitored from any number of VRF Explorers (Up to 5 connections simultaneously).

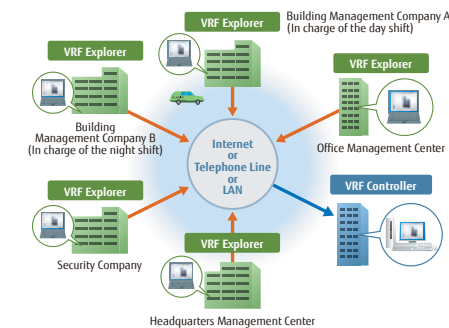

Standard for System Controller
Option for System Controller Lite UTY-PLGXRI

1 VRF Explorer can control or monitor up to 10 sites.

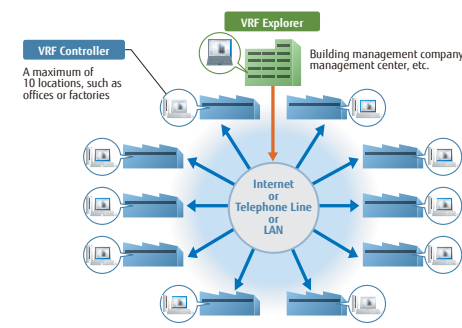

Web Operation

PC and smartphones can be used as simple remote controller. (Indoor unit user setting is necessary to operate it from System Controller side)

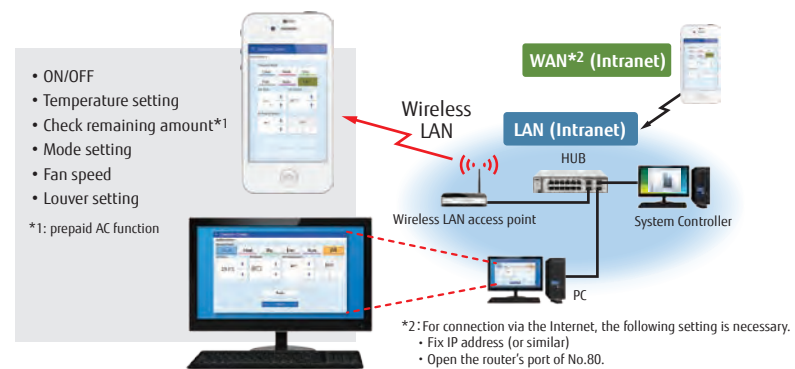

Energy saving management

A variety of energy saving operations can be set and managed depending on the season, weather, and time period. Excellent energy saving operation is performed while keeping users comfortable.

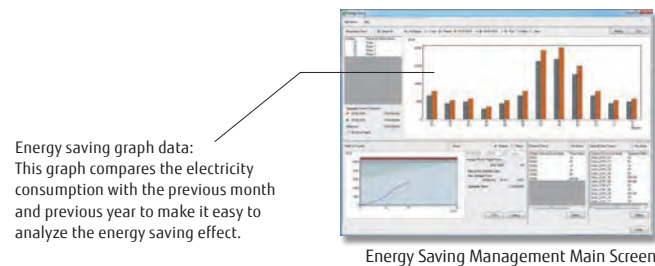

Option for System Controller UTY-PEGX
Option for System Controller Lite UTY-PLGXEI

Peak cut operation

A power meter is connected to detect the total power consumption while shifting the indoor unit set temperature, set the indoor unit forced thermostat off, and taking other measures to carefully control the power consumed while maintaining comfort and conducting control to maintain the target power consumption set for each time. The indoor units to be controlled can be freely grouped and the control level can be set.

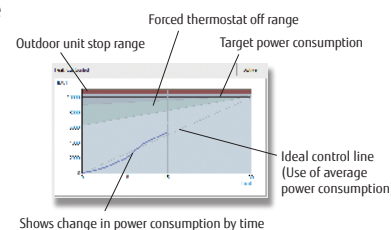

Indoor unit lead lag operation

The operation of indoor units can be automatically rotated within a group in accordance with the set annual schedule to reduce power consumption while maintaining comfort. The indoor unit operation stoppage rate can be selected.

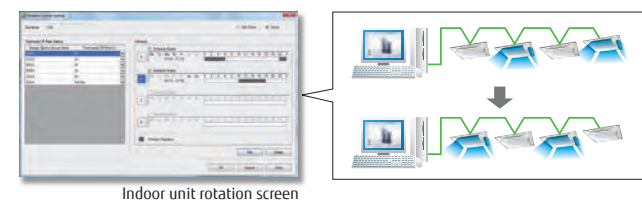

Outdoor unit capacity limit

Outdoor unit capacity limit switches the outdoor unit capability upper limit to suppress power consumption during hot summers and cold winters by averaging the power saving effect of each refrigerant system. You can select from 50% or more of the capacity upper limit.

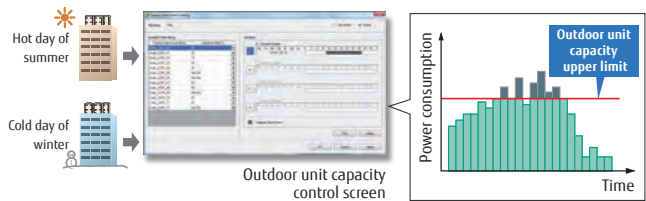

FUNCTIONS SUMMARY

Function	Type	System controller		System controller lite				
		UTY-APGXZ1	Option UTY-PEGXZ1	UTY-ALGXZ1	Option UTY-PLGXR2	Option UTY-PLGXA2	Option UTY-PLGXE2	Option UTY-PLGXX2
System specification	Max. VRF networks supported	4	—	1	—	—	—	—
	Max. indoor unit / remote controller groups per VRF network	400	—	400	—	—	—	—
	Max. outdoor units per System controller	100	—	100	—	—	—	—
	Max. indoor units / remote controller groups per System controller	1600	—	400	—	—	—	—
	Max. outdoor units per System controller	400	—	100	—	—	—	—
Site supervision	Multi site display	10	—	10	—	—	—	—
	Number of building / 1 site	20	—	—	—	—	—	—
	Number of floor per 1 site	200	—	—	—	—	—	—
	Number of floor per 1 building	50	—	—	—	—	—	—
	3D graphical layout view	●	—	—	—	—	—	—
	2D graphical layout view	●	—	—	—	—	—	—
	List display	●	—	—	—	—	—	—
Error management	Error notification	●	—	●	—	—	—	—
	Audible alarm	●	—	●	—	—	—	—
	Error e-mail notification	●	—	●	—	—	—	—
History	Error history	●	—	●	—	—	—	—
	Operation history	●	—	●	—	—	—	—
Operation control	Individual control	On/Off	●	—	●	—	—	—
		Operation mode	●	—	●	—	—	—
		Room temperature	●	—	●	—	—	—
		Fan speed	●	—	●	—	—	—
		Air flow direction	●	—	●	—	—	—
		Economy mode	●	—	●	—	—	—
		Room temperature set point limitation	●	—	●	—	—	—
		Antifreeze	●	—	●	—	—	—
		Outdoor unit low noise setting	●	—	●	—	—	—
		Remote control prohibition setting	●	—	●	—	—	—
	Individual management	Temperature upper and lower limit setting	●	—	●	—	—	—
		Filter sign reset	●	—	●	—	—	—
		Memory operation	●	—	●	—	—	—
Other	Pattern operation	●	—	●	—	—	—	
	Web operation	●	—	●	—	—	—	
Schedule	Annual Schedule	●	—	●	—	—	—	
	Exception day setting	●	—	●	—	—	—	
	On / off per day	72	—	72	—	—	—	
	On / off per week	504	—	504	—	—	—	
	Day off	●	—	●	—	—	—	
	Min. unit of timer setting (Minutes)	10	—	10	—	—	—	
Remote management	Web Operation	●	—	●	—	—	—	
	Remote monitoring	●	—	●	—	—	—	
	Remote operation control	●	—	●	—	—	—	
	Remote function setting	●	—	●	—	—	—	
Electricity charge apportionment	Apportionment charge/bill calculation	●	—	●	—	—	—	
	Tenant (block) setting	●	—	●	—	—	—	
	Common facilities apportionment setting	●	—	●	—	—	—	
	Rated power consumption allotment setting	●	—	●	—	—	—	
	Individual calculation at cooling and heating	—	●*	—	—	—	—	
Energy saving management	Electricity meter supported	●	—	●	—	—	—	
	Indoor unit lead lag	—	●	—	—	—	●	
	Peak cut control	—	●	—	—	—	●	
	Outdoor unit capacity limit	—	●	—	—	—	●	
	Record of energy saving operation	—	●	—	—	—	●	
	Energy saving information	—	●	—	—	—	●	
External Device Control	Monitor	●	—	—	—	—	●	
	Control	●	—	—	—	—	●	
Others	Database import/export	●	—	●	—	—	—	
	Automatic clock adjustment	●	—	●	—	—	—	
	Multi-language	7 languages	—	7 languages	—	—	—	

●: Available. —: Not available. *:Power calculation application software is necessary, please contact the local FGL representative.

Personal computer system requirements

The required PC specifications are shown in the following table.

	System Controller	System Controller Lite
Operating system	<ul style="list-style-type: none"> Microsoft® Windows® 7 Home Premium (32-bit or 64-bit) SP1, Windows® 7 Professional (32-bit or 64-bit) SP1 Microsoft® Windows® 8.1 (32-bit or 64-bit), Windows® 8.1 Pro (32-bit or 64-bit) Microsoft® Windows® 10 Home (32-bit or 64-bit), Windows® 10 Pro (32-bit or 64-bit) [Supported languages] English, Chinese, French, German, Russian, Spanish, and Polish	<ul style="list-style-type: none"> Microsoft® Windows® 7 Home Premium (32-bit or 64-bit) SP1, Windows® 7 Professional (32-bit or 64-bit) SP1 Microsoft® Windows® 8.1 (32-bit or 64-bit), Windows® 8.1 Pro (32-bit or 64-bit) Microsoft® Windows® 10 Home (32-bit or 64-bit), Windows® 10 Pro (32-bit or 64-bit) [Supported languages] English, Chinese, French, German, Russian, Spanish, and Polish
CPU	Intel® Core™ i3 2 GHz or higher	Intel® Core™ i3 2 GHz or higher
Memory	• 2 GB or more (for Windows® 7 [32-bit]) • 4 GB or more (for Windows® 7 [64-bit], Windows® 8.1, and Windows® 10)	• 2 GB or more (for Windows® 7 [32-bit]) • 4 GB or more (for Windows® 7 [64-bit], Windows® 8.1, and Windows® 10)
HDD	40 GB or more of free space	40 GB or more of free space
Display	1024 x 768 or higher resolution	1024 x 768 or higher resolution
Interface	<ul style="list-style-type: none"> Ethernet port (for getting access to the Internet using LAN) or Modem (for getting access to the Internet using Public Telephone Line) USB ports (Maximum of 6 ports) (Required only for the Server PC that works as VRF Controller) Maximum of 2 USB ports are required for WHITE-USB-KEY/WibuKey connection Maximum of 4 USB ports are required for Echelon™ U10 USB Network Interface * Maximum number of required USB port depends on the applicable system configuration. 	<ul style="list-style-type: none"> Ethernet port (for getting access to the Internet using LAN) or Modem (for getting access to the Internet using Public Telephone Line) USB ports (Maximum of 6 ports) (Required only for the Server PC that works as VRF Controller) Maximum of 4 USB ports are required for WHITE-USB-KEY/WibuKey connection Maximum of 4 USB ports are required for Echelon™ U10 USB Network Interface * The maximum number of required USB port depends on the applicable system configuration.
Graphic accelerator	Microsoft® DirectX™ 9.0c compatible	Microsoft® DirectX™ 9.0c compatible
Software	Adobe® Reader™ 9.0 or later	Adobe® Reader™ 9.0 or later

* Echelon™ U10 USB Network Interface - TP/FT-10 Channel (Model number: 75010R) (Required for each VRF Network.)re.

<PACKING LIST>

Type	For System controller			For System controller Lite			
	System controller	Option Energy manager	System Controller Lite	Remote access	Option Electricity charge apportionment	Option Energy saving	Option Central Control
Model name	UTY-APGXZ1	UTY-PEGXZ1	UTY-ALGXZ1	UTY-PLGXR2	UTY-PLGXA2	UTY-PLGXE2	UTY-PLGXX2
WHITE-USB-KEY	1	1	1	1	1	1	1

*1: Software protection key to be inserted in a USB slot running System Controller or System Controller Lite.

System Controller or System Controller Lite may only run on a PC with WHITE-USB-KEY. However, WHITE-USB-KEY is not required for remote VRF Explorer software.

BACnet™ Gateway

UTY-ABGXZ1

- It is possible to connect medium to large sized BMS to VRF network system via BACnet™, a global standard for open networks.
- A maximum of 1600 indoor units with 4 VRF network systems (a maximum of 400 indoor units & 100 outdoor units for one network system) can be connected to one BACnet™ Gateway.
- It is possible to control or monitor VRF network system from BMS via BACnet™ Gateway.
- Compatible with BACnet™ (ANSI / ASHRAE-135-2014) application specific controller (B-ASC).
- Compatible with BACnet™/IP over Ethernet.
- Scheduling function, Alarm & Event functions as well as Electricity Change Apportionment function are provided in BACnet™ Gateway.
- Connection between VRF network system to personal computer is possible via small U10 USB interface. However, both U10 USB interface & personal computer are field supplied items.
- Corresponds to 7 different languages, English, Chinese, French, German, Spanish, Russian, Polish.

Functions

Installation example

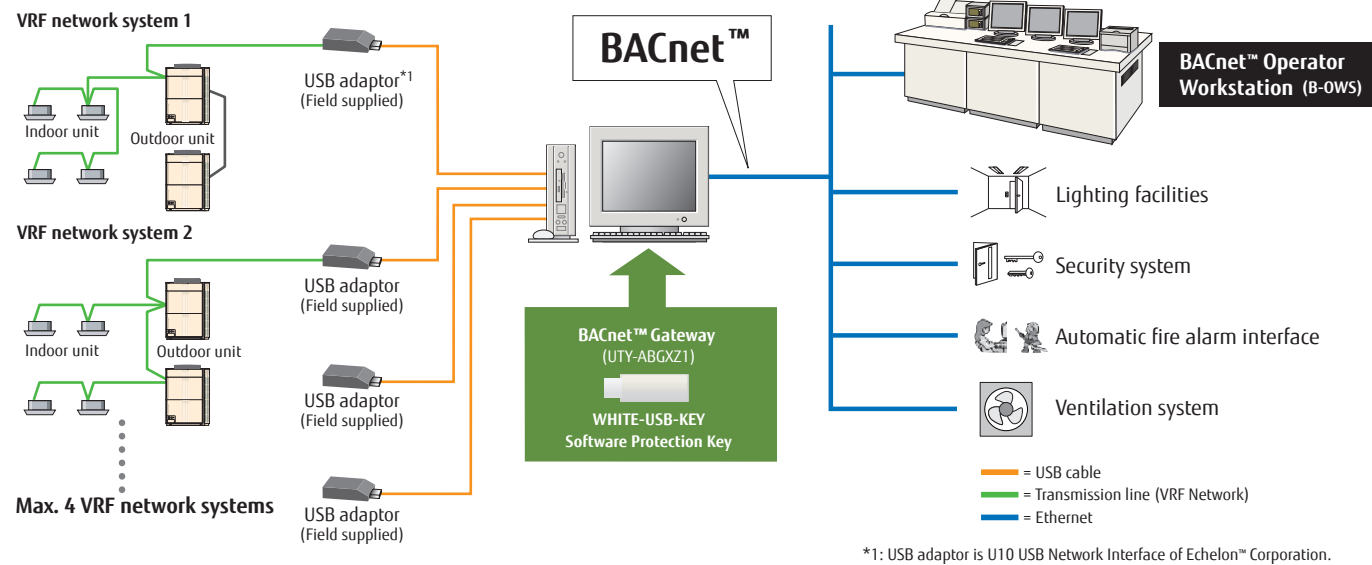

Personal computer system requirements

	UTY-ABGXZ1
Operating system	<ul style="list-style-type: none"> • Microsoft® Windows® 7 Home Premium (32-bit or 64-bit) SP1, Windows® 7 Professional (32-bit or 64-bit) SP1 • Microsoft® Windows® 8.1 (32-bit or 64-bit), Windows® 8.1 Pro (32-bit or 64-bit) • Microsoft® Windows® 10 Home (32-bit or 64-bit), Windows® 10 Pro (32-bit or 64-bit) [Supported languages] English, Chinese, French, German, Russian, Spanish, and Polish
CPU	Intel® Core™ i3 2 GHz or higher
Memory	<ul style="list-style-type: none"> • 2 GB or more (for Windows® 7 [32-bit]) • 4 GB or more (for Windows® 7 [64-bit], Windows® 8.1, and Windows® 10)
HDD	40 GB or more of free space
Display	1024 x 768 or higher resolution
Interface	<ul style="list-style-type: none"> • Ethernet port (for getting access to the Internet using LAN) • USB ports (Maximum of 5 ports) - 1 USB port is required for WHITE-USB-KEY/WibuKey connection - Maximum of 4 USB ports are required for Echelon™ U10 USB Network Interface * Maximum number of required USB ports depends on the applicable system configurations.
Software	Adobe® Reader™ 9.0 or later
	• Echelon™ U10 USB Network Interface – TP/FT-10 Channel (Model number: 75010R) (Required for each VRF Network.)

<PACKING LIST>

Name and shape	Quantity	Application
WHITE-USB-KEY	1	Includes the software and manuals, license for BACnet™ Gateway.

Maximum controllable VRF network systems	Maximum controllable indoor units	Maximum controllable outdoor units
4	1,600	400



BACnet is a registered trademark of ASHRAE. ASHRAE does not endorse, approve or test products for compliance with ASHRAE standards. Compliance of listed products to the requirements of ASHRAE Standard 135 is the responsibility of BACnet International (BI). BTL is a registered trademark of BACnet International.



BACnet™ Gateway (Hardware)

UTY-VBGX

- BACnet™ Gateway enables to connect a BMS and FG VRF system.
- A maximum of 128 indoor units and 32 refrigerant system can be connected to a single BACnet™ Gateway.
- Compatible with BACnet™ (ANSI / ASHRAE-135-2012) application specific controller (B-ASC).
- Compatible with BACnet™/IP over Ethernet.



BACnet is a registered trademark of ASHRAE. ASHRAE does not endorse, approve or test products for compliance with ASHRAE standards. Compliance of listed products to the requirements of ASHRAE Standard 135 is the responsibility of BACnet International (BI). BTL is a registered trademark of BACnet International.



Maximum controllable VRF network system	Maximum controllable refrigerant system	Maximum controllable indoor units
1	32	128

Functions

Installation example

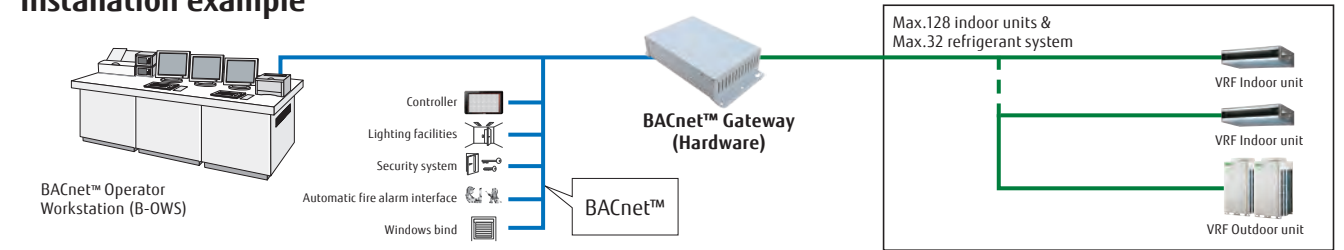

Specifications

Model name	UTY-VBGX
Number of controllable indoor units	128
Number of controllable refrigerant system	32
Number of controllable VRF network	1
Number of connectable units / one VRF network	4

Model name	UTY-VBGX
Power Supply	100-240V 50/60Hz, single phase
Power Consumption	W 4.6 (max)
Dimensions (H x W x D)	mm 59.6 x 270.4 x 176
Weight	g 1,200

Network Converter for LONWORKS™

UTY-VLGX

- For connection between VRF network system and a LONWORKS™ open network for management of small to medium-sized BMS and VRF network system.
- The UTY-VLGX permits central monitoring and control of a VRF network system from a BMS through a LONWORKS™ interface.
- Up to 128 Indoor units can be connected to one Network Converter for LONWORKS™

Maximum controllable Units to BMS	Maximum controllable indoor units	Maximum controllable outdoor units
4	128	100



Functions

Installation example

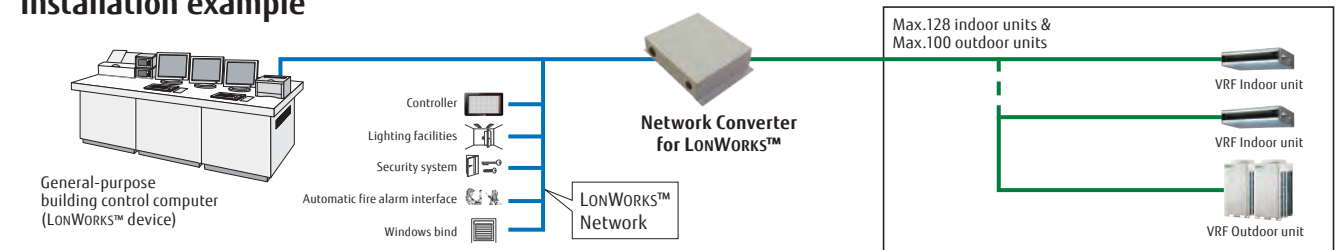

Specifications

Model name	UTY-VLGX
Power Supply	208-240V 50/60Hz, Single phase
Power Consumption	W 4.5
Dimensions (H x W x D)	mm 67 x 288 x 211
Weight	g 1,500

Transmission specifications (BMS side)

Transmission speed	78 kbps
Transceiver	FT-X1 (Echelon™ Corporation)
Transmission way form	Free topology
Terminal resistor	None (It attaches at the terminal of a network.)

MODBUS™ Converter (for VRF)

Maximum connectable
9
units to one VRF

Maximum controllible
128
indoor units

Maximum controllible
100
outdoor units

UTY-VMGX

The MODBUS Converter allows a complete integration of air conditioners into MODBUS Networks.

- Compact and lightweight design
- Direct connection to MODBUS Network
- Up to 128 indoor units can be controlled in one MODBUS Converter
- The MODBUS Converter permits central monitoring and control of air conditioners from BMS or Central Controller.

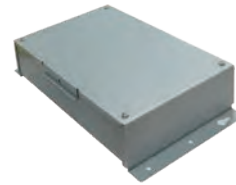

Functions

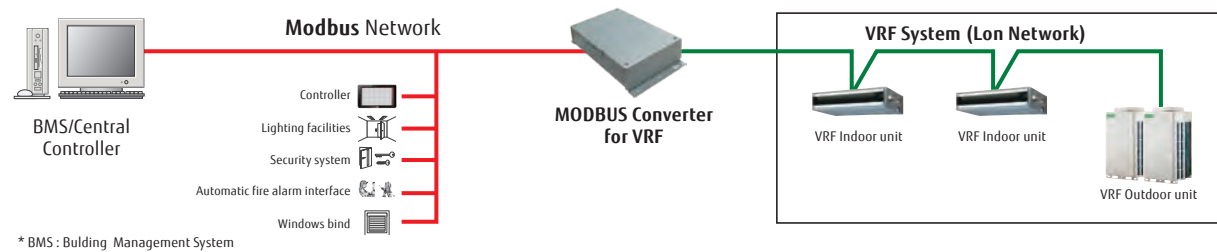

Specifications

Model name	UTY-VMGX	
Power Supply	220-240V 50/60Hz	
Input power	W	Max. 2
Dimensions (H x W x D)	mm	54 × 260 × 150
Weight	g	1,100

KNX™ Converter (for VRF)

Maximum controllible
128
indoor units

Maximum controllible
100
outdoor units

UTY-VKGX

It is possible to control the VRF system from central / home controller via KNX network.

- New KNX Converter enables to connect central/home controller and FG VRF system.
- A maximum of 128 indoor units and 100 outdoor units can be connected to single KNX Converter.

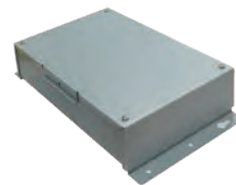

Functions

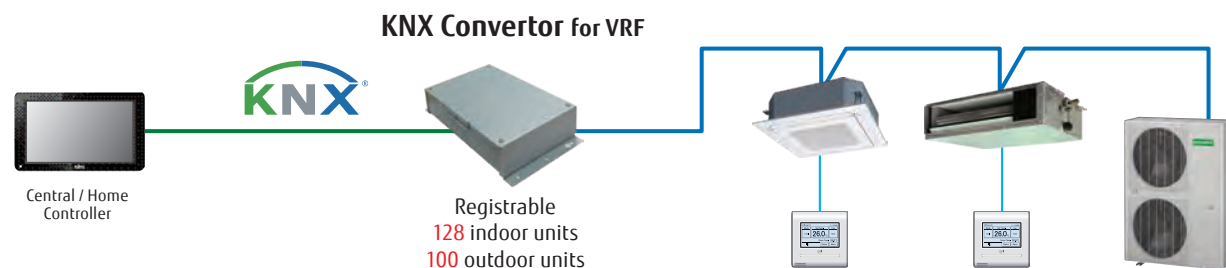

Specifications

Model name	UTY-VKGX	
Power Supply	220-240V 50/60Hz	
Input power	W	1.5
Dimensions (H x W x D)	mm	54 × 260 × 150
Weight	g	1,200

MODBUS™ Converter (for Indoor unit)

Maximum controllible
1
Single indoor unit

UTY-VMSX

The MODBUS Converter allows a complete integration of air conditioners into MODBUS Networks.

- Simple installation due to small and compact size.
- No separate external power supply required.
- The MODBUS Converter must be connected one by one in the indoor unit.
- The MODBUS Controller permits central monitoring and control of air conditioners from BMS/Central/Home Controller.



Functions

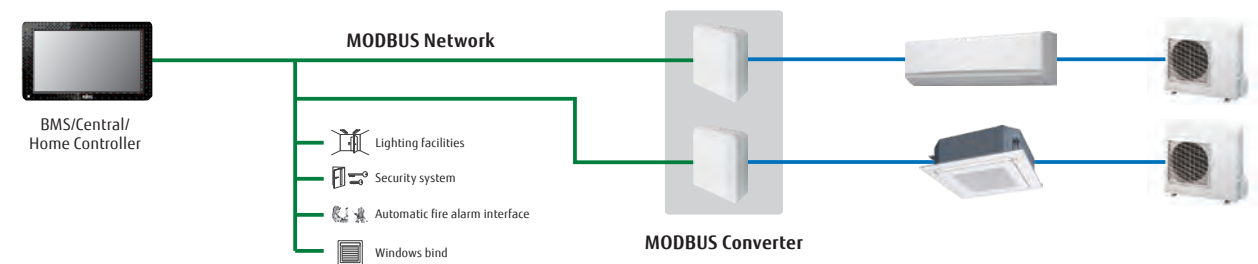

Specifications

Model name	UTY-VMSX	
Power Supply	DC12V	
Input Power	W	Max. 1.2
Dimensions (H x W x D)	mm	140 × 117 × 43
Weight	g	200

Temperature	Operating / Packaged	°C	0-46 / -10-60
Humidity	Operating / Packaged	%	0-95 / 0-95
Maximum Connectable indoor unit number per 1 MODBUS Converter			1

KNX™ Converter (for Indoor unit)

Maximum controllible
1
Single indoor unit

UTY-VKSX

It is possible to control the VRF system from central / home controller via KNX network.

- New KNX Converter enables to connect central/ home controller and FG indoor unit.
- Compact and light weight design



Functions

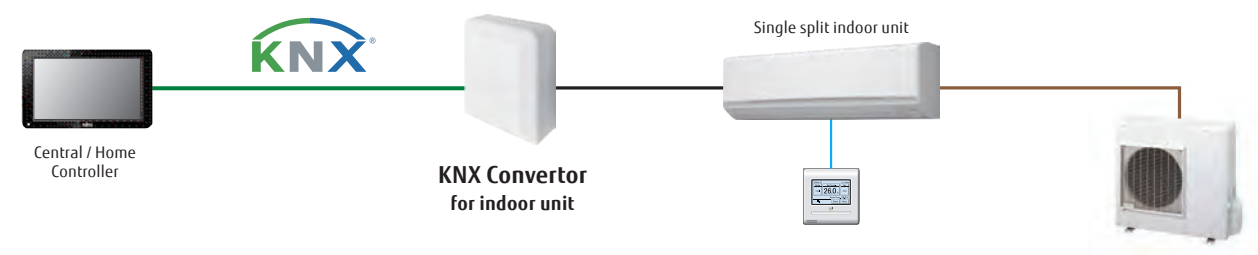

Specifications

Model name	UTY-VKSX	
Power Supply	(DC12V)	
Input power	W	0.6
Dimensions (H x W x D)	mm	140 × 117 × 43
Weight	g	250

Wireless LAN Adapter

UTY-TFSXZ2

- It is the most advanced solution to remotely manage an Air Conditioning system using all sort of mobile devices such as Smartphones, and tablets.
- No separate external power supply required
- Can be used for single indoor units and multi-split system indoor units

Maximum controllable
1
Single indoor unit



Functions

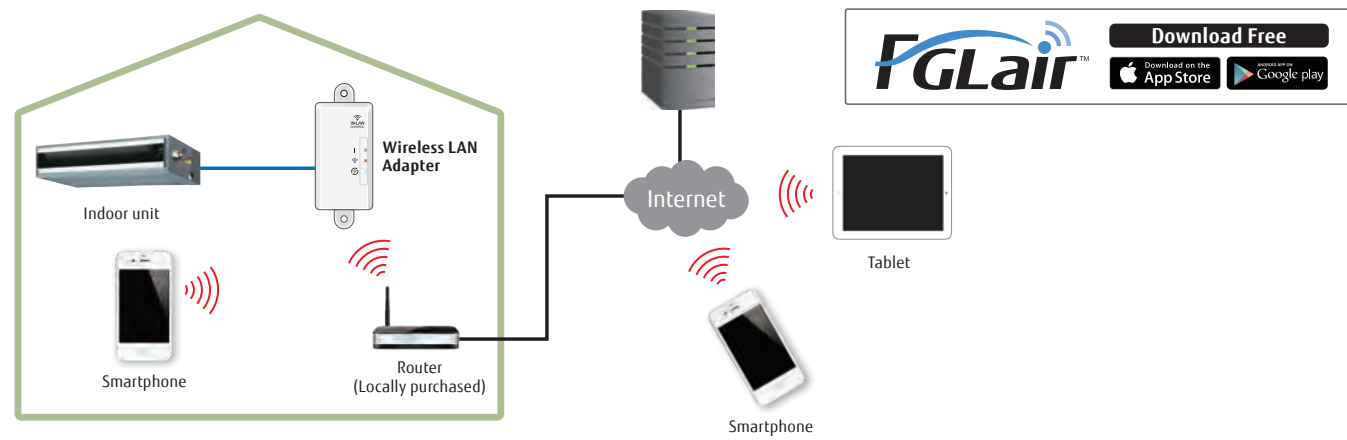

Basic control

- Turning the units on and off
- Mode control (Heat, Cool, Dry, Auto, Fan)
- Fan speed setting
- Louver position (Airflow direction setting)
- Timer operation setting (Weekly timer)
- Economy mode setting

Error display & E-mail notification

- Alerts e-mail notification
- Air conditioning malfunction display
- It enables rapid service response when error occurs.

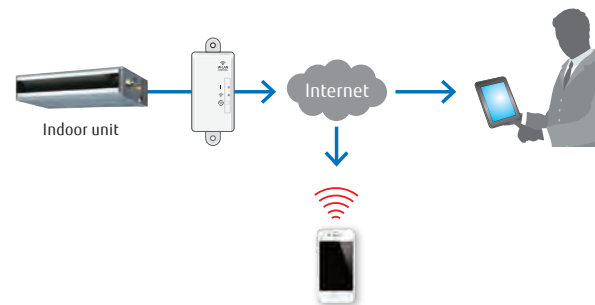

Multiple air conditioning management

- Multiple air conditioning management at difference locations.

Multi system

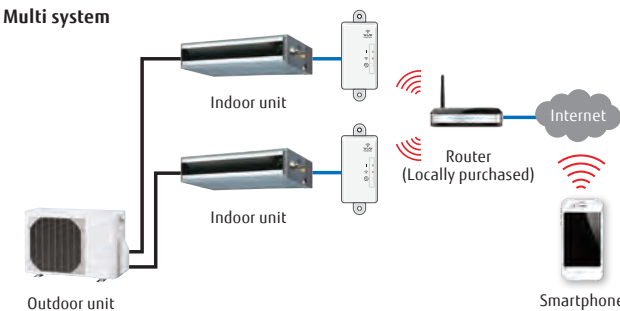

Specifications

Model name	UTY-TFSXZ2	
Dimensions (H x W x D)	mm	71 x 38 x 15
Weight	g	35

Wireless LAN Adapter IntesisHome®

FJ-RC-WIFI-1

- It is the most advanced solution to remotely manage an Air Conditioning system using all sort of mobile devices such as Smartphones, Tablets and PC
- No separate external power supply required
- Can be used for single indoor units and group controlled (up to 16) indoor units

Maximum controllable
1
Single indoor unit



Functions

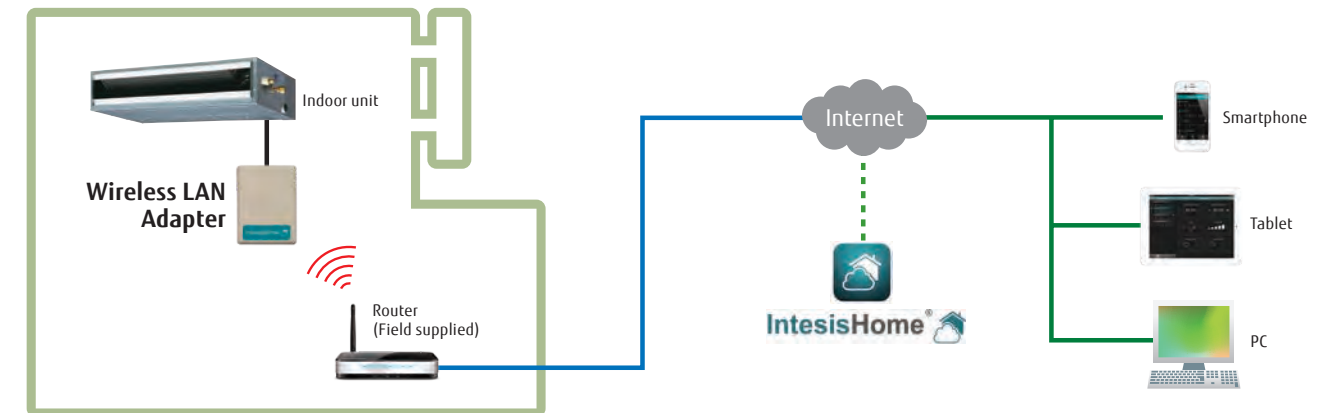

Basic control

- Turning the units on and off
- Mode control (Heat, Cool, Dry, Auto, Fan)
- Fan speed setting
- Louver position (Airflow direction setting)
- Room temperature display
- Set temperature control
- Multi Language
- One Scene and Timer



Advanced control (Optional functions)

- Climate working modes (ECO, Comfort, Powerful) (future release)
- Schedulable functionalities (ON/OFF, Modes, Set point temperature, Fan Speed, Louver position)
- Set temperature limitation (future release)
- Multiple Scenes & Timers and Calendar function

Notifications and History

- Alerts e-mail notification (future release)
- Air conditioning malfunction alerts
- Connectivity monitoring and alerts
- History (future release)

Specifications

Model name	FJ-RC-WIFI-1	
Dimensions (H x W x D)	mm	108 x 70 x 28
Weight	g	80

External Switch Controller

Maximum controllable
1
group



UTY-TERX

- In combination with a field supply Card-Key Switch or other sensor, the External Switch Controller allows control of the ON / OFF, Room temperature, Fan speed and Master control functions. This makes this product suitable for installations such as hotel rooms.
- Card-key or other sensor switches are available as a locally purchased parts.
- The set temperature can be specified at two points for cooling and heating individually (4 points).

Functions

Installation example

Human sensor catches movements of people in a room, and operates with lower capacity when people come back to the room, it automatically returns to previous operation mode.

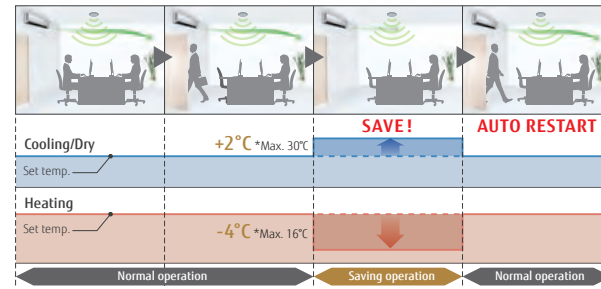

Human sensor equipment needs to be purchased locally. The above example indicated that a signal is sent to this External Switch Controller if human sensor does not detect for 20 minutes. Human sensor is not mounted on the External Switch Controller.

Specifications

Model name	UTY-TERX	
Power Supply	DC 6.5-16V	
Dimensions (H x W x D)	mm	140 x 117 x 43
Weight	g	250

DC12V is supplied by indoor unit.

Signal Amplifier

UTY-VSGXZ1

- Transmission Line length can be extended up to 3,600m with multiple Signal Amplifiers.
- Up to 40 signal amplifiers can be installed in a VRF network system.
- A signal amplifier is required,
 - (1) When the total wiring length of the transmission line exceeds 500m.
 - (2) When the total number of units on the transmission line exceeds 64.

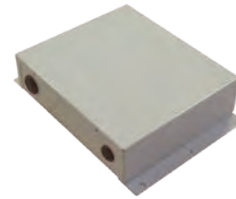

Functions

Installation example

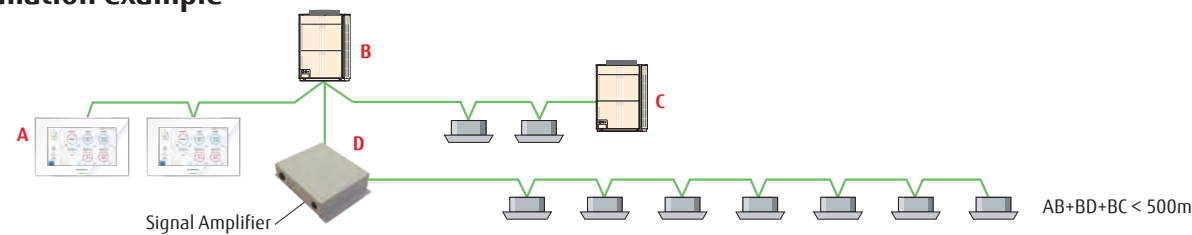

Specifications

Model name	UTY-VSGXZ1	
Power Supply	208-240V 50/60Hz, Single phase	
Input power	W	4.5
Dimensions (H x W x D)	mm	67 x 288 x 211
Weight	g	1,500



OPTION

Diverse building air conditioning control functions can be controlled easily by VRF options.

Various kinds of optional parts are provided such as controllers, adaptors and converters to meet the needs of every user.

External Power Supply Unit

Auto Louver Grille Kit

CONTROL SYSTEM LIST

OPTIONAL PARTS LIST

OPTIONAL PARTS

FUNCTION LIST

SEPARATION TUBE etc.



External Power Supply Unit

Models
UTZ-GXXC

The External power supply unit protects the increment in the system even if the power supply for some of the indoor units is shut down.

Connects to the External power supply unit to supply power to the indoor unit from the auxiliary power supply. This allows for continuous operation without system errors. Built-in relays reduce installation time and cost. The UTZ-GXXC has a built-in relay, which reduces installation time and cost.



Feature

High reliability

- A: Interruption of the main power supply is detected by the power cut-off detection part.
- B: Supplies power for driving the expansion valve of the indoor unit. (12 V or 5 V DC)
- C: Gives notification of the power supply from the External power supply unit.

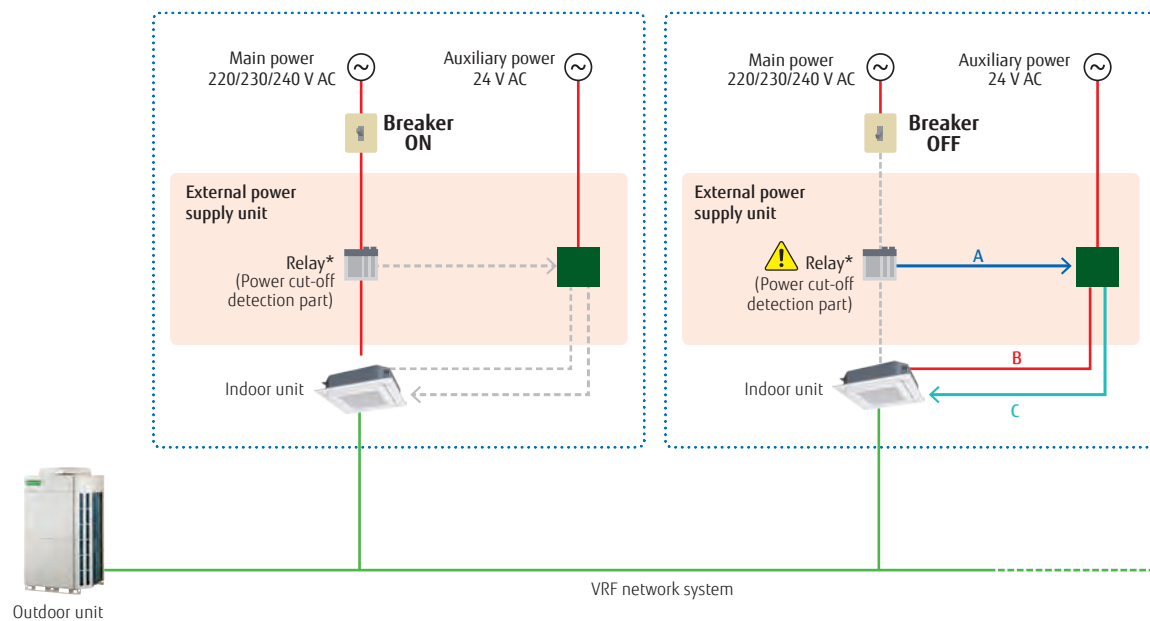

Note

- When changing the power supply voltage to 24 V AC, use a power transformer with an insulated structure that complies with the regulations* of the installation region.
- A powered-off indoor unit driven by the External power supply unit is treated in the same way as an operation-off unit in the electricity charge appointment function. If standby power is generated, the result of the electricity charge appointment may not be zero.
- * UL Class II or IEC 61558 Class III, for example.

Specifications

Model name	UTZ-GXXC	
Power Supply	24 V AC 50/60 Hz	
Dimensions (H × W × D)	mm	97 × 200 × 178
Weight	g	800

Auto Louver Grille Kit

Models
UTD-GXTA-W
UTD-GXTB-W
UTD-GXTC-W

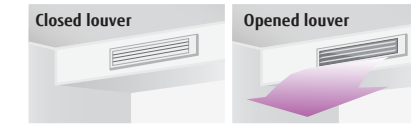

Feature

Flexible Control

- **Operation with indoor unit**
Auto Louver can be operated by synchronizing remote controller of indoor unit.
- **UP and Down auto swing**
 - Auto airflow direction and auto swing
 - 4 steps selectable
- **Auto-closing louver**
When operation of indoor unit is stopped, the louver will automatically close.

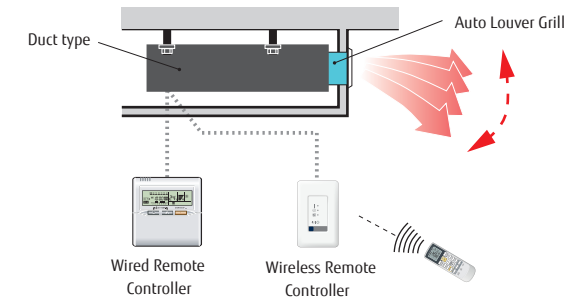

Dimensions

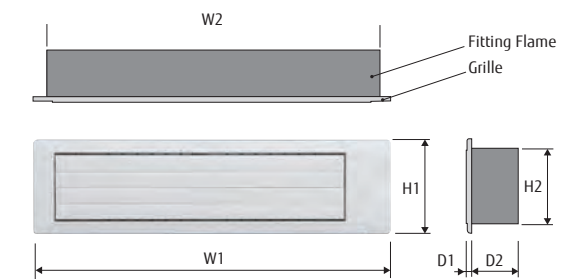

Model Name	W1	W2	H1	H2	D1	D2
UTD-GXTA-W	683	645	180	148	9	84
UTD-GXTB-W	883	845				
UTD-GXTC-W	1,083	1,045				

Unit: mm

Specifications

Model name	UTD-GXTA-W	UTD-GXTB-W	UTD-GXTC-W
Applicable Indoor Unit	ARXD007/009/012/014GLEH ARXD07/09/12/14GATH ARXK007/009/012/014GLGH ARXK007/009/012/014GLFH	ARXD018GLEH ARXD18GATH ARXK018GLGH ARXK018GLFH	ARXD024GLEH ARXD24GATH ARXK024GLGH ARXK024GLFH
Power source	Connecting with Control box of indoor unit		
Fixing of Auto Louver Grille	Screw fixing to Flange or Square Duct		
Extension Square Duct Limit	1.0m (Max. duct length between indoor unit and Grille)		
Dimensions (H × W × D)	mm	180 × 683 × (84+9)	180 × 883 × (84+9)
Weight	Net	kg	2.0
	Gross		3.0
Color	White		
Louver Motor	Stepping Motor		
Accessories	Fitting Flame, etc.		
Operating range	Cooling	°C	18 to 32
		% RH	80% or less
	Heating	°C	16 to 30

CONTROL SYSTEM LIST

Controllers / Interface

Type	Indoor unit														Indoor unit						
	Cassette						Duct		Duct						Floor	Ceiling / Floor	Ceiling	Wall Mounted			
	1-way Flow	3D Flow	4-way Flow Compact Grid type/ Standard type	4-way Flow Slim type/ Large type	Circular Flow Slim type	Circular Flow Large type	Mini (With drain pump)	Low Static Pressure	Slim (With drain pump)	Medium Static Pressure	High Static Pressure		ASHA 07/09/12/14 GATH	ASHA 007/009/012/014 GCGH				ASHA 18/24GBCH, ASHA 18/24GACH	ASHA 007/009/030/034 GTEH		
AUXV 007/009/012/014/018/024 GLEH	AUXS 018/024GLEH	AUXB 007/009/012/014/018/024 GLEH, AUXB 09/12/14/18/24 GATH	AUXD 18/24GALH, AUXA 18/24/30/34/36/45/54 GALH	AUXM 018/024/030 GLEH, AUXM 018/024GTAH	AUXK 018/024/030/034/036/045/054 GLEH, AUXK 030/036/045/054 GTAH	ARXK 007/009/012/014/018/024 GLGH	ARXB 07/09/12/14/18/24/30/36/45 GALH	ARXD 007/009/012/014/018/024 GLEH, ARXD 07/09/12/14/18/24 GATH	ARXA 024/030/036/045 GLEH, ARXA 24/30/36/45 GBTH	ARXC 036/045/060 GTEH	ARXC 072/090/096 GTEH	AGHA 007/009/012/014 GCGH	ABHA 012/014/018/024 GTEH	ABHA 030/036/045/054 GTEH	ASHA 07/09/12/14 GATH	ASHA 007/009/012/014 GCGH	ASHA 18/24GBCH, ASHA 18/24GACH	ASHA 007/009/030/034 GTEH			
Controllers	Wired Remote Controller	● UTY-RNRGZ5														● UTY-RNRGZ5					
		● UTY-RLRG														● UTY-RLRG					
		● UTY-RCRGZ1, UTY-RCRGZ1K														● UTY-RCRGZ1, UTY-RCRGZ1K					
	Simple Remote Controller	● UTY-RSRG, UTY-RHRG														● UTY-RSRG, UTY-RHRG					
	Wireless Remote Controller	● UTY-LNHG														● UTY-LNHG					
	Central Remote Controller	● UTY-DCGGZ2														● UTY-DCGGZ2					
	Touch Panel Controller	● UTY-DTGGZ1														● UTY-DTGGZ1					
System Controller, System Controller Lite	● UTY-APGXZ1, UTY-ALGXZ1														● UTY-APGXZ1, UTY-ALGXZ1						
Interface	BACnet Gateway	● UTY-ABGXZ1, UTY-VBGX														● UTY-ABGXZ1, UTY-VBGX					
	Network Converter for LONWORKS	● UTY-VLGX														● UTY-VLGX					
	MODBUS Converter for Indoor unit	● UTY-VMSX	● UTY-VMSX (GLEH)	● UTY-VMSX				● UTY-VMSX (GLEH)						● UTY-VMSX	● UTY-VMSX (GTEH)	● UTY-VMSX	● UTY-VMSX				
	MODBUS Converter for VRF	● UTY-VMGX														● UTY-VMGX					
	KNX Converter for Indoor unit	● UTY-VKSX	● UTY-VKSX (GLEH)	● UTY-VKSX				● UTY-VKSX (GLEH)						● UTY-VKSX	● UTY-VKSX (GTEH)	● UTY-VKSX	● UTY-VKSX				
	KNX Converter for VRF	● UTY-VKGX														● UTY-VKGX					
	Wireless LAN Adapter	● UTY-TFSXZ2	● UTY-TFSXZ2 (GLEH)	● UTY-TFSXZ2				● UTY-TFSXZ2 (GLEH)						● UTY-TFSXZ2		● UTY-TFSXZ2	● UTY-TFSXZ2				
● FJ-RC-WIFI-1 (GATH)		● FJ-RC-WIFI-1	● FJ-RC-WIFI-1				● FJ-RC-WIFI-1 (GATH)		● FJ-RC-WIFI-1 (GBTH)		● FJ-RC-WIFI-1				● FJ-RC-WIFI-1	● FJ-RC-WIFI-1					
External Switch Controller	● UTY-TERX														● UTY-TERX						

OPTIONAL PARTS LIST











Others

Type	Indoor unit														Indoor unit						Outdoor unit						
	Cassette						Duct				Duct				Floor	Ceiling / Floor	Ceiling	Wall Mounted				V-III	V-III Tropical				
	1-way Flow	3D Flow	4-way Flow Compact Grid type/ Standard type	4-way Flow Slim type/ Large type	Circular Flow Slim type	Circular Flow Large type	Mini (With drain pump)	Low Static Pressure	Slim (With drain pump)	Medium Static Pressure	High Static Pressure		ASHA 07/09/12/14 GATH	ASHA 007/009/030/034 GTEH				ASHA 007/009/012/014 CCGH	ASHA 18/24/30/36/45 GACH	ASHA 007/009/030/034 GTEH	AJH 072/090/108/ 126/144/162 LALBH			AJH 072/090/108/ 126/144/162 LNTCH			
IR Receiver Unit	● UTY-TRHX		● UTY-LRHGB1		● UTY-LBHXD		● UTY-TRHX		● UTB-YWC		● UTY-TRHX (GLEH) UTB-YWC (GATH/GBTH)		● UTY-TRHX														
Occupancy Sensor Kit	● UTY-SHZXC																										
Remote Sensor Unit							● UTY-XSZXZ1				● UTY-XSZXZ1																
Cassette Grille	● UTG-UNGA-W (007/009/012) UTG-UNGB-W (014/018/024)		● UTG-USGA-W		● UTG-UFGE-W UTG-UFGC-W		● UTG-UGGA-W		● UTG-UKGC-W UTG-UKGA-B																		
Auto Louver Grille Kit							● UTD-GXTA-W (7/9/12/14) UTD-GXTB-W (18) UTD-GXTC-W (24)		● UTD-GXTA-W (7/9/12/14) UTD-GXTB-W (18) UTD-GXTC-W (24)																		
Silver ion filter II																									● UTR-FA16-B (30/34)		
Long Life Filter											● UTD-LF25NA		● UTD-LF60KA														
Flange											● UTD-SF045T UTD-RF204																
Drain Pump Unit							● UTZ-PX1BBA (07/09/12/14/18) UTZ-PX1NBA (24/30/36/45)		● UTZ-PX1NBA																		
Wide Panel			● UTG-AKXA-W		● UTG-AKXA-W																						
Panel Spacer			● UTG-BKXA-W		● UTG-BKXA-W																						
Fresh Air Intake Kit			● UTZ-VXAA		● UTZ-VXRA		● UTZ-VXRA																				
Air Outlet Shutter Plate			● UTR-YDZB		● UTR-YDZK		● UTR-YDZK																				
Insulation for High Humidity			● UTZ-KXGC		● UTZ-KXRA		● UTZ-KXRA																				
Half Concealed Kit																											
External Power Supply Unit	● UTZ-GXXC		● UTZ-GXXC (GLEH)		● UTZ-GXXC (GLEH)		● UTZ-GXXC		● UTZ-GXXC (GLEH)		● UTZ-GXXC		● UTZ-GXXC		● UTZ-GXXC (CCGH,GTEH)		● UTZ-GXXC		● UTZ-GXXC								
Pressure Sensor Kit																									● UTY-SPWX		



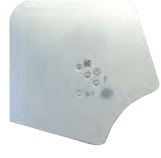

OPTIONAL PARTS

Controllers

For Individual Control

<p>Wired Remote Controller (Touch Panel) UTY-RNRGZ5</p> 	<p>Wired Remote Controller UTY-RLRG</p> 	<p>Compact Wired Remote Controller UTY-RCRGZ1</p> 
<p>Compact Wired Remote Controller UTY-RCRGZ1K</p> 	<p>Simple Remote Controller UTY-RSRG With operation mode</p> 	<p>Simple Remote Controller UTY-RHRG Without operation mode</p> 
<p>Wireless Remote Controller UTY-LNHG</p> 	<p>IR Receiver Unit UTB-YWC, UTY-TRHX For 3D Flow Cassette, Duct type</p> 	<p>IR Receiver Unit UTY-LRHGB1 For Cassette type</p> 
<p>IR Receiver Unit UTY-LBHDX For Circular Flow Cassette type</p> 	<p>Occupancy Sensor Kit UTY-SHZXC For Circular Flow Cassette type</p> 	

For Centralized Control

<p>Central Remote Controller UTY-DCGGZ2</p> 	<p>Touch Panel Controller UTY-DTGGZ1</p> 	<p>System Controller Lite Software UTY-ALGXZ1 WHITE-USB-KEY (Software Protection Key)</p> <p>Option</p> <p>UTY-PLGXR2, UTY-PLGXA2 UTY-PLGX2, UTY-PLGXX2</p> 
<p>System Controller Software UTY-APGXZ1 WHITE-USB-KEY (Software Protection Key)</p> <p>Option</p> <p>UTY-PEGXZ1</p> 		

Converters / Adaptors

For External device

<p>BACnet™ Gateway Software UTY-ABGXZ1 WHITE-USB-KEY (Software Protection Key)</p> 	<p>BACnet™ Gateway Hardware UTY-VBGX</p> 	<p>Network Converter for LONWORKS™ UTY-VLGX</p> 
<p>MODBUS™ Converter for VRF UTY-VMGX</p> 	<p>KNX™ Converter for VRF UTY-VKGX</p> 	<p>MODBUS™ Converter for Indoor unit UTY-VMSX</p> 
<p>KNX™ Converter for Indoor unit UTY-VK SX</p> 	<p>Wireless LAN Adapter FJ-RC-WIFI-1</p> 	<p>Wireless LAN Adapter UTY-TFSXZ2</p> 

For System expansion

<p>External Switch Controller UTY-TERX</p> 	<p>Signal Amplifier UTY-VSGXZ1</p> 	
---	---	--

OPTIONAL PARTS





Panels

For Cassette type

Cassette Grille UTG-UFGE-W For 4-way Flow Compact Cassette Grid type 	Cassette Grille UTG-UFGC-W For 4-way Flow Compact Cassette Standard type 	Cassette Grille UTG-UGGA-W For 4-way Flow Cassette type 
Cassette Grille UTG-UKGC-W For Circular Flow Cassette type 	Cassette Grille UTG-UKGA-B For Circular Flow Cassette type 	Cassette Grille UTG-USGA-W For 3D Flow Cassette type 
Cassette Grille UTG-UNGA-W For 1-way Flow Cassette type 	Cassette Grille UTG-UNGB-W For 1-way Flow Cassette type 	

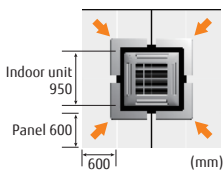
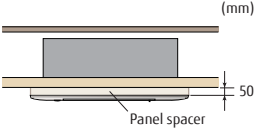
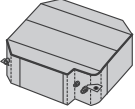
Others

For Cassette type

Wide Panel UTG-AKXA-W For Cassette type 	Panel Spacer UTG-BKXA-W For Cassette type 	Insulation Kit for High Humidity UTZ-KXRA For Cassette type UTZ-KXGC For Compact Cassette type 
Fresh Air Intake Kit UTZ-VXAA For Compact Cassette type UTZ-VXRA For Cassette type 	Air Outlet Shutter Plate UTR-YDZB For Compact Cassette type Shuts the air outlet when only using as 3 blow out. 	Air Outlet Shutter Plate UTR-YDZK For Cassette type Shuts the air outlet when only using as 3 blow out. 

* Not applicable for VRF V-II Tropical and V-III Tropical Series

For Ceiling type

Drain Pump Unit UTR-DPB24T For Ceiling type 
--

For Floor type

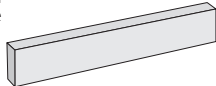





Half Concealed Kit UTR-STA For Floor type This kit is used to half conceal floor type indoor unit into the wall. 
--

For Wall Mounted type

Silver ion filter II UTR-FA16-8 

Others

For Duct type

Flange (Round) UTD-RF204 For Medium Static Pressure Duct type / Ceiling type 	Flange (Square) UTD-SF045T For Medium Static Pressure Duct type 	Remote Sensor Unit UTU-XSZXZ1 For All Duct type New amenity space can be offered by installing the Remote sensor. 
Long-Life Filter UTD-LF25NA For Medium Static Pressure Duct type UTD-LF60KA For High Static Pressure Duct type 	Auto Louver Grille Kit UTD-GXTA-W (for ARXD04/07/09/12/14, ARXK04/07/09/12/14) UTD-GXTB-W (for ARXD18, ARXK18) UTD-GXTC-W (for ARXD24, ARXK24) For Slim Duct type / Mini Duct type 	Drain Pump Unit UTZ-PX1BBA UTZ-PX1NBA 

For Indoor Unit

External Power Supply Unit UTZ-GXXC 

For Outdoor Unit

Pressure Sensor Kit UTU-SPWX For V-III, V-III Tropical 

Communication system: External Connect Kit

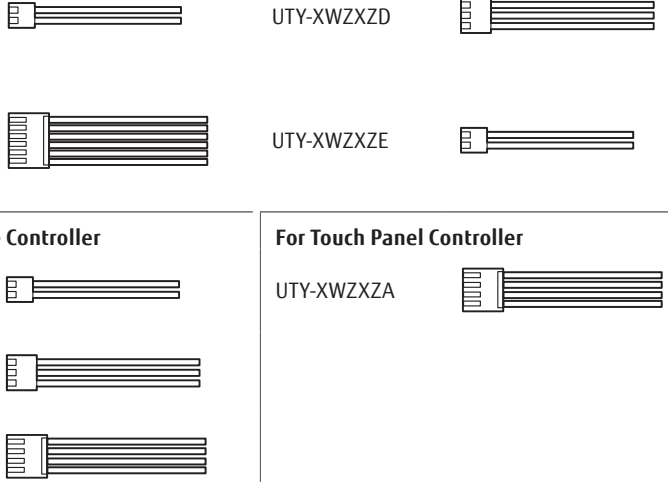
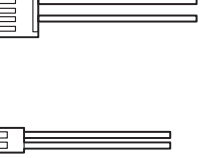
For Indoor unit UTU-XWZXZ7 UTU-XWZXZC UTU-XWZXZ7 UTU-XWZXZ8 UTU-XWZXZA		For Outdoor unit UTU-XWZXZ9 UTU-XWZXZF	
--	---	---	---

FUNCTION LIST

External Input and Output Function/External Connect Kit/Communication Kit

Type	Indoor unit											Indoor unit						Outdoor unit						Controller								
	Cassette				Duct							Floor	Ceiling / Floor	Ceiling	Wall Mounted				J-III	J-III	J-III Tropical	J-III	V-III	V-III Tropical	Central Remote Controller	Touch Panel Controller						
	One way flow cassette	3D Flow	4-way Flow Compact Grid type/ Standard type	4-way Flow Slim type/ Large type	Circular Flow Slim type	Circular Flow Large type	Mini (With drain pump)	Low Static Pressure	Slim (With drain pump)	Medium Static Pressure	High Static Pressure				ASHA	ASHA	ASHA	ASHA									ASHA	ASHA	ASHA	ASHA	ASHA	ASHA
	AUXV 007/009/012/ 014/018/024 GLEH	AUXS 018/024GLEH	AUXB 007/009/012/ 014/018/024 GLEH, AUXB 09/12/14/18/24 GATH	AUXD 18/24GALH, AUXA 18/24/30/34/ 36/45/54 GALH	AUXM 018/024/030 GLEH, AUXM 018/024GTAH	AUXK 018/024/030/ 034/036/045/054 GLEH, AUXK 030/036/045/054 GTAH	ARXK 007/009/012/ 014/018/024 GLGH	ARXB 07/09/12/14/18/ 24/30/36/45 GALH	ARXD 007/009/012/ 014/018/024 GLEH, ARXD 07/09/12/ 14/18/24 GATH	ARXA 024/030/ 036/045 GLEH, ARXA 24/30/36/45 GBTH	ARXC 036/045/ 060/072/ 090/096 GTEH	AGHA 007/009/ 012/014 GCGH	ABHA 012/014/ 018/024 GTEH	ABHA 030/036/ 045/054 GTEH	ASHA 07/09/12/14 GATH	ASHA 007/009 012/014 GCGH	ASHA 18/24GBCH, ASHA 18/24GACH	ASHA 007/009/ 030/034 GTEH	AJH 072/090/108/ 126/144/162 LELAH	AJH 040/045/054 LBLAH, AJH 040/045/054 LELAH	AJH 040/045/054 LBTAHN, AJH 040/045/054 LETAHN	AJH 040/045/054 LCLAH	AJH 072/090/108 126/144/162 LALBH	AJH 072/090/108 126/144/162 LNTCH	UTY-DCGGZ2	UTY-DTGGZ1						
Input	●UTY-XWZXZD											●UTY-XWZXZD																				
All On / All Off																											●UTY-XWZXZ7 ○UTY-XWZXZ8	●*2 ○*2				
Forced Stop	●UTY-XWZXZD											●UTY-XWZXZD																				
Emergency Stop	●UTY-XWZXZD											●UTY-XWZXZD																		●UTY-XWZXZ7 ○UTY-XWZXZ8	●*2 ○*2	
Forced Thermostat off	●UTY-XWZXZE ○UTY-XWZXZ7											●UTY-XWZXZE ○UTY-XWZXZ7																				
Power Usage Information from Electricity Meter																											●UTY-XWZXZF	●*2 ○*2				
Output	●UTY-XWZXZC											●UTY-XWZXZC																		○UTY-XWZXZA		
Operation Status	●UTY-XWZXZC											●UTY-XWZXZC																			○UTY-XWZXZA	
Error Status	●UTY-XWZXZC											●UTY-XWZXZC																			○UTY-XWZXZA	
Indoor Unit Fun Operation Status	●UTY-XWZXZC											●UTY-XWZXZC																				
Auxiliary Heater Output																																
Base Heater																											●UTY-XWZXZ9	●UTY-XWZXZ9				











*1: Touch Panel Controller has these functions for Dry contact and Apply voltage, however, above External Connect Kit is not necessary because Touch Panel Controller has an external input terminal block.

●: Dry Contact ○: Apply Voltage





SEPARATION TUBE etc.

Connection Units

Separation Tube

<p>UTP-AX054A</p> <p>Gas Pipe </p> <p>Liquid Pipe </p>	<p>UTP-AX090A</p> <p>Gas Pipe </p> <p>Liquid Pipe </p>	<p>UTP-AX180A</p> <p>Gas Pipe </p> <p>Liquid Pipe </p>
<p>UTP-AX567A</p> <p>Gas Pipe </p> <p>Liquid Pipe </p>	<p>UTP-LX180A for DX Kit</p>  	

Header

<p>UTR-H0906L / UTR-H1806L</p> <p>Gas Pipe </p> <p>Liquid Pipe </p>	<p>UTR-H0908L / UTR-H1808L</p> <p>Gas Pipe </p> <p>Liquid Pipe </p>	
---	---	--

Outdoor Unit Branch Kit

<p>UTP-CX567A</p> <p>Gas Pipe </p> <p>Liquid Pipe </p>		
--	--	--

Specifications

Separation Tube

Model name		UTP-AX054A	UTP-AX090A	UTP-AX180A	UTP-AX567A
Total cooling capacity of indoor unit	kW	19.6 or less	28.0 or less	28.1 to 56.0	56.1 or more

Header

Model name	3-6 Branches	UTR-H0906L	UTR-H1806L
	3-8 Branches	UTR-H0908L	UTR-H1808L
Total cooling capacity of indoor unit	kW	28.0 or less	28.1 to 56.0

Outdoor unit Branch kit

Model name	UTP-CX567A (for V-III / V-III Tropical)	
Model name	2 outdoor units	1
	3 outdoor units	2

SUPPORT

Our know-how supports you not only during the product release but also from guiding implementation to product maintenance.

SUPPORT

VRF / RAC SUPPORT TOOL

QUICK SERVICE & MAINTENANCE

SERVICE TOOL

WEB MONITORING TOOL

Category	Information Material											Tool				
	Product Sales Training Material	Product Technical Training Material	Product news	Brochures	Feature Promotion Movie	Operating Manual	Design & Technical Manual	Certificate Data	2D CAD Data	3D CAD (Revit) Data	Installation Manual	Service Manual	Design Simulator (Room air conditioner, Packaged air conditioner, VRF)	CFD Simulation	Service Tool / Web Monitoring Tool	Mobile Technician
Product Training	•	•														
Product Information Seek			•	•	•	•	•									
Technical Information Seek						•	•									
Model Selection						•							•			
Design						•		•	•							
Verification													•			
Installation						•				•						
After sales and Service											•			•	•	



SUPPORT

Fujitsu General provides a variety of product and technical information to engineers and consultants, and also conducts new product research and design support activities. We provide a wide range of support to maintain high quality from design to installation.

Training

Fujitsu General has many training facilities around the world that regularly conduct specialized product, technical, and service training. These research facilities also support the development of people with high technical capability.

Features

- Designing VRF Systems
- Control System on-site training

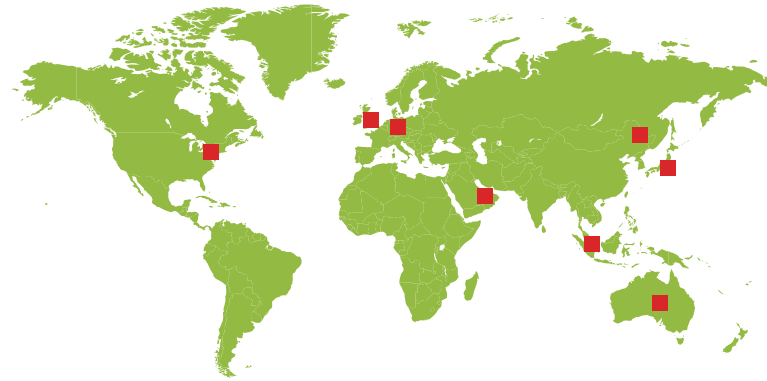

- 1 Head office training center in Japan
- 2 Training center in China
- 3 Asia training center in Singapore
- 4 Europe training center in the United Kingdom
- 5 Europe training center in Germany
- 6 America training center in the United States
- 7 Middle East training center in the UAE
- 8 Oceania training center in Australia

Technical information

We provide information and tools that are useful for air conditioning system design, such as unit performance data and tools that make model selection and estimation easy.

Features

- Design & Technical Manual
- Model Selection & Estimation
- Certificate Data
- 2D/3D CAD Data

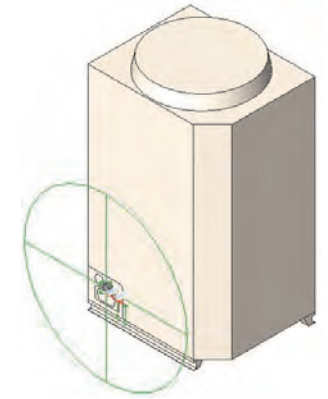

Product information

New product information is provided in the form of documents and movies for every new model released. These can be downloaded from a private section of our website. To access this website, please contact your Fujitsu representative.

Features

- Product News
- Brochures & All Manuals
- Feature Promotion Movie



Technical support

Technical support is provided at every stage from design to installation to assist in providing the most suitable air conditioning solution.

Features

- CFD Simulation
- Guide line
- Commissioning Support

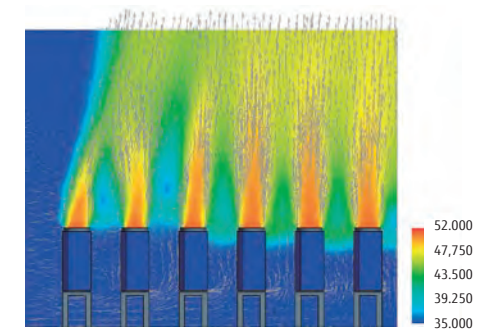

CFD Simulation



Commissioning Support

VRF / RAC SUPPORT TOOL

Put the charts and pens away and design your projects on your computer with ease using the Design Simulator. Everything from selecting indoor and outdoor units, allocating controls and optional parts to designing the piping and wiring systems is made easier using the program's built-in features. Once your project is designed take advantage of the Export functions to easily get materials lists, product specifications, refrigerant calculations and more - it'll even export to Word, Excel, or Acrobat formats, and group the relevant CAD data for your project.

Design Simulator

Automatically create model selection information

- Each unit can be automatically set by entering the required performance, type, and temperature conditions for each indoor unit and then dragging and dropping into the outdoor unit.
- Piping and wiring diagrams can be created automatically and it is easy to set branches, grouping, and options.
- The additional refrigerant charging amount is automatically calculated when the pipe length is entered.
- It is also easy to set the remote controller groups, central controller and converters.
- The equipment list including the equipment information is created automatically.

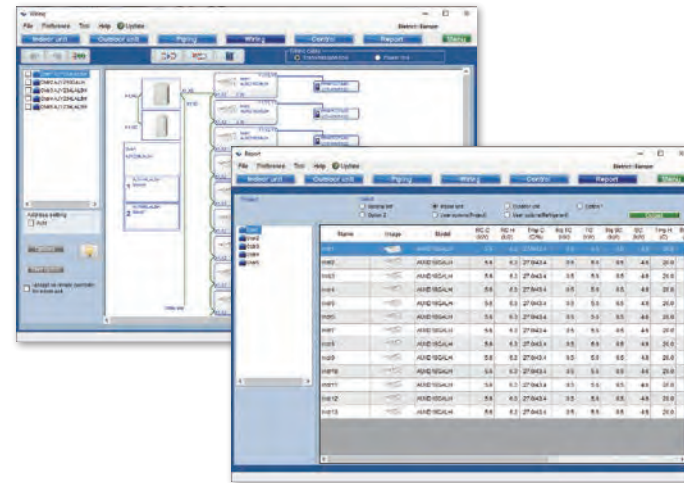

Output the format that matches the application

The information specific to your project can be exported in a number of industry standard file formats.

- Word format (rtf)(doc)
- Excel format (csv)
- Acrobat format (pdf)
- 2D CAD data (DXF)



Update your Design Simulator

Database can be easily updated online using AutoUpdate function through FTP.

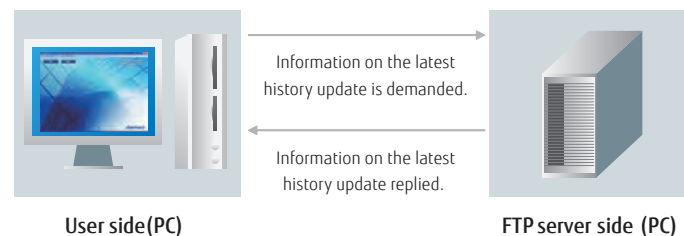

BIM Building Information Modeling

BIM files of Fujitsu General's products available on BIMobject™

We are pleased to inform that Fujitsu General has released BIM files of products on BIMobject™'s website (BIMobject.com).

Outline of BIMobject
BIMobject™ is a game changer for the construction industry, offering development, maintenance, and syndication of objects on the world's biggest BIM platform.

About the BIM file

- BIM files are Autodesk Revit 2018 version.
- Each of the BIM files has different refrigerant and drain piping connector location.
- Each of the BIM file includes several family types.
- Revit file type catalog (Specification) is available for every product.



www.bimobject.com/en



Go to search bar and key in the brand name FUJITSU GENERAL to search the products



RFA (Revit data)

Data format available for BIM-designed projects.

Data content

- Shape (Size)
- Drain direction
- Piping direction
- Power source location
- Specifications etc.



Type catalog (specifications of product)



DWG

Standard data available for Autodesk's products.



DXF

Intermediate data generally available for CAD products.

Data content

- Shape (Size)



*How to use the BIM files please refer to Instruction video on each product page.

youtu.be/wfL-hwFQ7dM

QUICK SERVICE & MAINTENANCE

If trouble should occur in a unit or system, abundant support tools such as trouble code display at the product, Service Tool that allows checking of the detailed status of the entire system, and remote monitoring tool that uses the internet, etc. support quick service and maintenance anywhere and at any time.

Mobile troubleshooting tool for iPhone & Android



We will release an App of troubleshooting tool for iPhone, iPod touch and other Apple products. This application is a troubleshooting tool for Fujitsu General air conditioner (Room air conditioner / Packaged air conditioner, VRF, FGLair, R32 calculation of allowable refrigerant capacity)

It helps you to check air conditioner condition. Error code check, Troubleshooting, and Sensor check are available.



Easy maintenance & monitoring

Design for easy maintenance

Design for easy maintenance
The air conditioner operating status and trouble status of the detailed are displayed at the 7-segment of the outdoor unit PCB or on the remote controller screen. The unit status can be checked rapidly and quick response is also possible.

- Operation mode status
- Discharge temperature/Pressure status
- Compressor operation indication
- Address/Type/Number of outdoor unit
- Error code.

7-segment LED

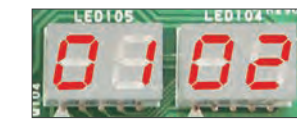

Wired Remote Controller (Touch panel)

Error status/Error history

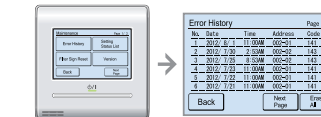

Wired Remote Controller

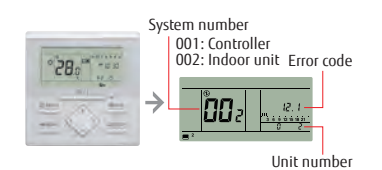

Error diagnosis by Service Tool

Error diagnosis by Service Tool
The unit status details for VRF system can be checked on PC screen by connecting Service Tool. Quick countermeasures can be taken

- Operation status/control
- Monitoring operating condition
- Monitoring sensor data
- Indication of trend graph
- Error history
- Indication of refrigerant circuit diagram
- Automatic operation check for refrigeration cycle

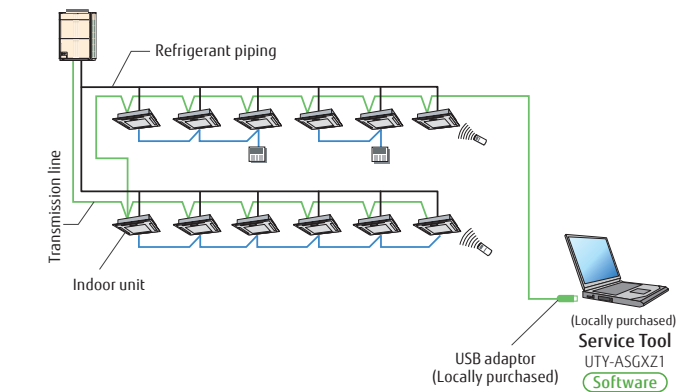

Remote monitoring

VRF system operating status and trouble status details can be constantly and remotely monitored over the Internet, etc. Rapid cooperation with the service personnel are also possible.

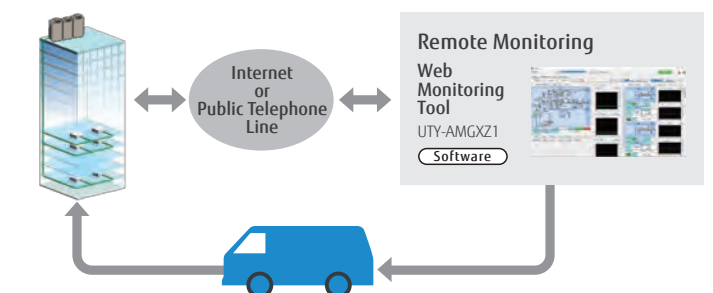

SERVICE TOOL

UTY-ASGXZ1

Extensive monitoring and analysis functions for installation and maintenance

- Operation status can be checked and analyzed to detect even the smallest abnormalities
- Storage of data on system operation status on a PC allows access even from off site.
- Up to 400 indoor units (a single VRF network system) can be controlled and monitored for large scale buildings or hotels
- This software can be connected to any point of transmission line with USB adaptor (locally purchased)

* The saved data can be displayed offline. However, the data saved by the following model cannot be displayed.

- UTR-YSTB/UTR-YSTC (Service Tool)
- UTR-YMSA (Web Monitoring Tool)

Functions

System Over View

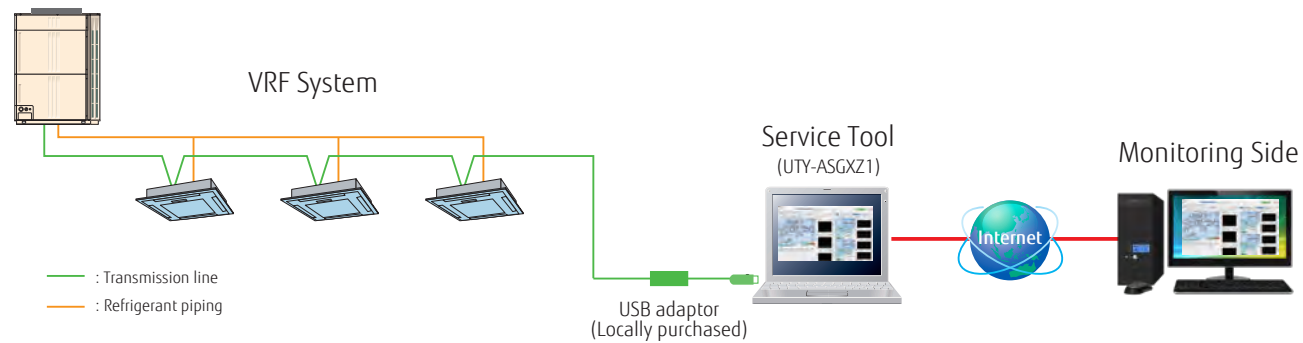

Automatic operation check for refrigeration cycle

After product installation, operation check can be performed automatically. Self-diagnosis function automatically judges whether each sensor value is normal, so the operation check work can be reduced. The diagnosis can also be output as a report.

Whether each sensor value is normal is judged automatically.

- ✓ Discharge temperature normal value OK
- ✓ Super heat volume normal value OK
- ✓ High pressure pipe normal value OK
- ✓ Low pressure pipe normal value OK
- ...etc.

[Note] Use only as a guide and judge for yourself finally.

Remote technical support & maintenance

On-site check screen can be shared with the skilled person in a distant place. When visiting for troubleshooting on site, operation status can be shared in real time and get assistance easily. Online chat function helps to support on site staff.

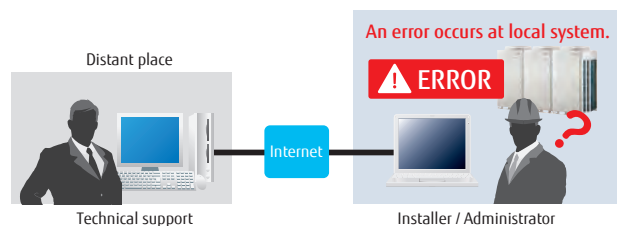

Various trend graph display

Previously, only 3 kinds of each sensor value can be displayed. However, multiple graphs can be displayed in new Service Tool depending on the situation. The refrigeration cycle can be checked in detail.

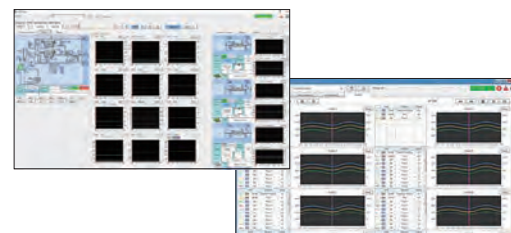

Custom Auto Function

Mode	Set Temp.(°C)	
Cool (Main)	-	
Custom Auto	28	23
Custom Auto	28	23

Custom Auto operation display

Custom Auto setting

Custom Auto settings: Cool 24 °C, Heat 20 °C, Deadband: 1.5 °C

Function summary

	UTY-ASGXZ1
Interchangeability of equipment	●
Indication of equipment list	●
Operation control	●
Indication of refrigerant circuit diagram	●
Commissioning tool	●
Storage and CSV output of operating history (sensor data)	●
Indication of trend graph	●
Printing of trend graph	●
Monitoring and screen display of abnormalities	●
E-mail automatic transmission of abnormalities	-
Network Topology Analyzer	●
Remote Setting	●
System Time Setting	●
Central Release	●
Model Name Writer	●
Error Memory Reader	●
Time Guard Information	●
Automatic operation check for refrigeration cycle	●
Many different kinds of graph display	●
Automatic update of software	●
Custom Auto function	●
Display of individual louver control function	●
Display of human sensor control function	●

Personal computer system requirements

	UTY-ASGXZ1
Operating system	<ul style="list-style-type: none"> • Microsoft® Windows® 7 Professional (32-bit or 64-bit) SP1 • Microsoft® Windows® 8.1 Pro (32-bit or 64-bit) • Microsoft® Windows® 10 Pro (32-bit or 64-bit)
CPU	1 GHz or higher
Memory	<ul style="list-style-type: none"> • 1 GB or more (for Windows® 7 [32-bit], Windows® 8.1 [32-bit], and Windows® 10 [32-bit]) • 2 GB or more (for Windows® 7 [64-bit], Windows® 8.1 [64-bit], and Windows® 10 [64-bit])
HDD	40 GB or more of free space
Display	1366 x 768 or higher resolution
Interface	• USB port for U10 USB Network Interface and Software protection key
Software	Internet Explorer® 11 or Microsoft Edge

• Echelon™ U10 USB Network Interface – TP/FT-10 Channel (Model number: 75010R) (Required for each VRF Network.)

<PACKING LIST>

Name and shape	Quantity	Application
WHITE-USB-KEY (Software protection key)	1	Software protection key to be connected to USB port on the Service Tool-installed PC. These products run only on a PC with WibuKey.

• Personal computer that satisfies the following system requirements

WEB MONITORING TOOL

UTY-AMGXZ1

Product features

- Troubleshooting is performed by monitoring each air conditioning unit remotely during periodical system checks.
- Error notification can be automatically transmitted to several locations using the internet *1.
- Requires either a dedicated internet connection or public telephone line.
- Determination of an error occurrence can be made through error warnings and equipment status information obtained from a remote location.
- The monitoring data in a remote side can be optionally downloaded. And, this data can be displayed in offline mode of the service tool.
- Monitoring side computer is not required to install special software, requires only general web browser.

*1: Use of internet mail system required.

Functions

Web Monitoring System

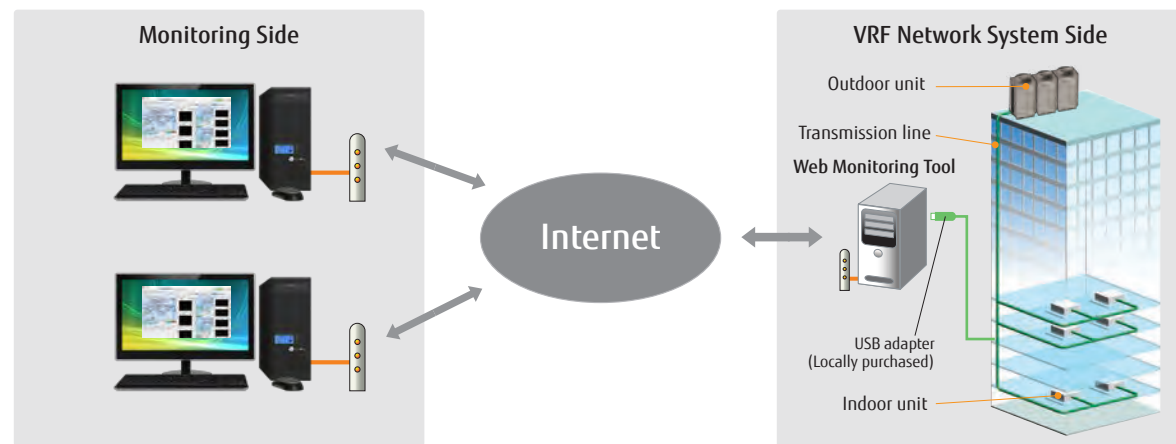

Support 4 VRF network systems

USB adaptor (maximum 4 adaptors per PC) permit, monitoring of up to 1,600 indoor units. Suitable for large-scale buildings or hotels.

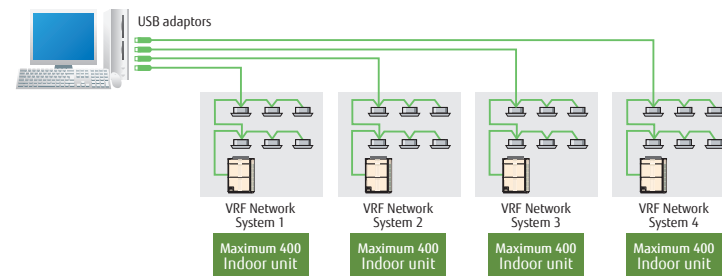

System components

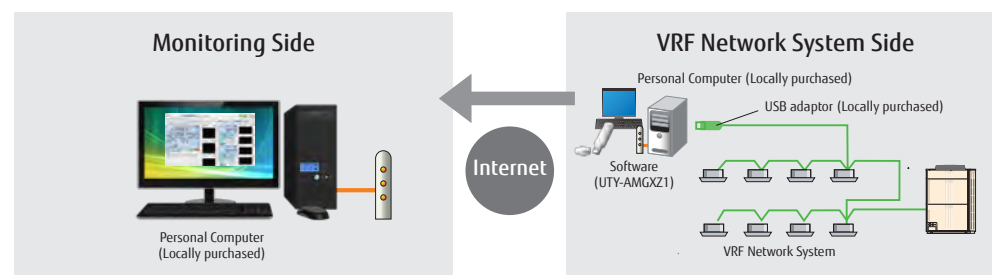

Custom Auto Function

Mode	Set Temp.(°C)	
Cool (Main)	-	-
Custom Auto	28	23
Custom Auto	28	23

Custom Auto operation display

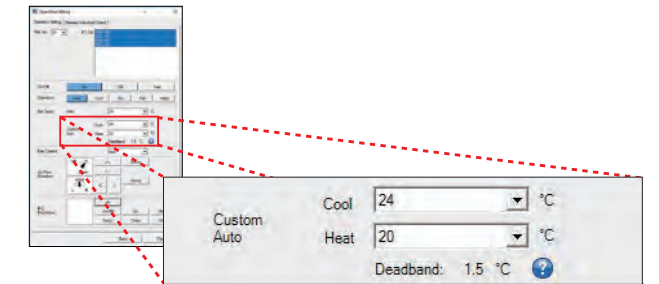

Custom Auto setting

Function summary

	UTY-AMGXZ1
Interchangeability of equipment	●
Indication of equipment list	●
Operation control	●
Indication of refrigerant circuit diagram	●
Commissioning tool	●
Storage and CSV output of operating history (sensor data)	●
Indication of trend graph	●
Printing of trend graph	●
Monitoring and screen display of abnormalities	●
E-mail automatic transmission of abnormalities	●
Network Topology Analyzer	●
Remote Setting	●
System Time Setting	●
Central Release	●
Model Name Writer	—
Error Memory Reader	—
Time Guard Information	●
Automatic operation check for refrigeration cycle	—
Many different kinds of graph display	—
Automatic update of software	●
Custom Auto function	●
Display of individual louver control function	●
Display of human sensor control function	●

Personal computer system requirements

	UTY-AMGXZ1
Operating system	<ul style="list-style-type: none"> • Microsoft® Windows® 7 Professional (32-bit or 64-bit) SP1 • Microsoft® Windows® 8.1 Pro (32-bit or 64-bit) • Microsoft® Windows® 10 Pro (32-bit or 64-bit)
CPU	1 GHz or higher
Memory	<ul style="list-style-type: none"> • 1 GB or more (for Windows® 7 [32-bit], Windows® 8.1 [32-bit], and Windows® 10 [32-bit]) • 2 GB or more (for Windows® 7 [64-bit], Windows® 8.1 [64-bit], and Windows® 10 [64-bit])
HDD	40 GB or more of free space
Display	1366 x 768 or higher resolution
Interface	<ul style="list-style-type: none"> • USB port (for 10 USB Network Interface maximum 4, Software protection key) • Either of the following interface is required for remote connection: <ul style="list-style-type: none"> - Public Telephone Line: Modem is required - Internet using LAN: Ethernet port is required
Software	Internet Explorer® 11 or Microsoft Edge

<PACKING LIST>

Name and shape	Quantity	Application
WHITE-USB-KEY (Software protection key)	1	Software protection key to be connected to USB port on the Service Tool-installed PC. These products run only on a PC with WibuKey.

•Personal computer that satisfies the following system requirements